

INTRODUCTION

PRODUCT SUMMARY

KS7332 is a digital image signal handling IC aimed at improving image contrast and counter light correction, applicable to CCD-using video camera systems such as camcorders and surveillance cameras. KS7332 receives the CCD output as digital data, analyzes the image's luminance distribution, then outputs a signal with improved dynamic range of luminance and color difference. It also uses a spatial adaptive filter to remove low intensity noise and output a stable image.

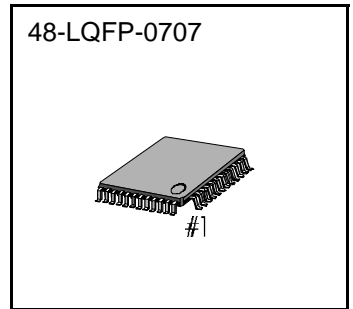

FEATURES

- NTSC/PAL, Normal/Hiband, DVC compatible
- 10-bit A/D input
- Digital clamp
- WDR expansion using non-linear histogram modification
- Look up table (LUT) transform using line memory
- S1, S2 signals' HUE component correction by look-up-table transform
- Built-in memory for histogram storage
- Image analysis with histogram LOG function as reference
- Color sensitivity correction
- Serial micom interface
- Built-in operation for connection with AE
- 10-bit S1, S2 signal output for DCP I/F
- Spatial adaptive noise removal filter for low intensity images
- Interpretation of image characteristic through graphic OSD

MANUFACTURING PROCESS AND PACKAGE

Manufacturing process: 0.35 um silicon gate 3 metals 3.3V CMOS (CSP7L)

APPLICATIONS

- Camcorder system
- Surveillance camera, PC camera

PIN DIAGRAM

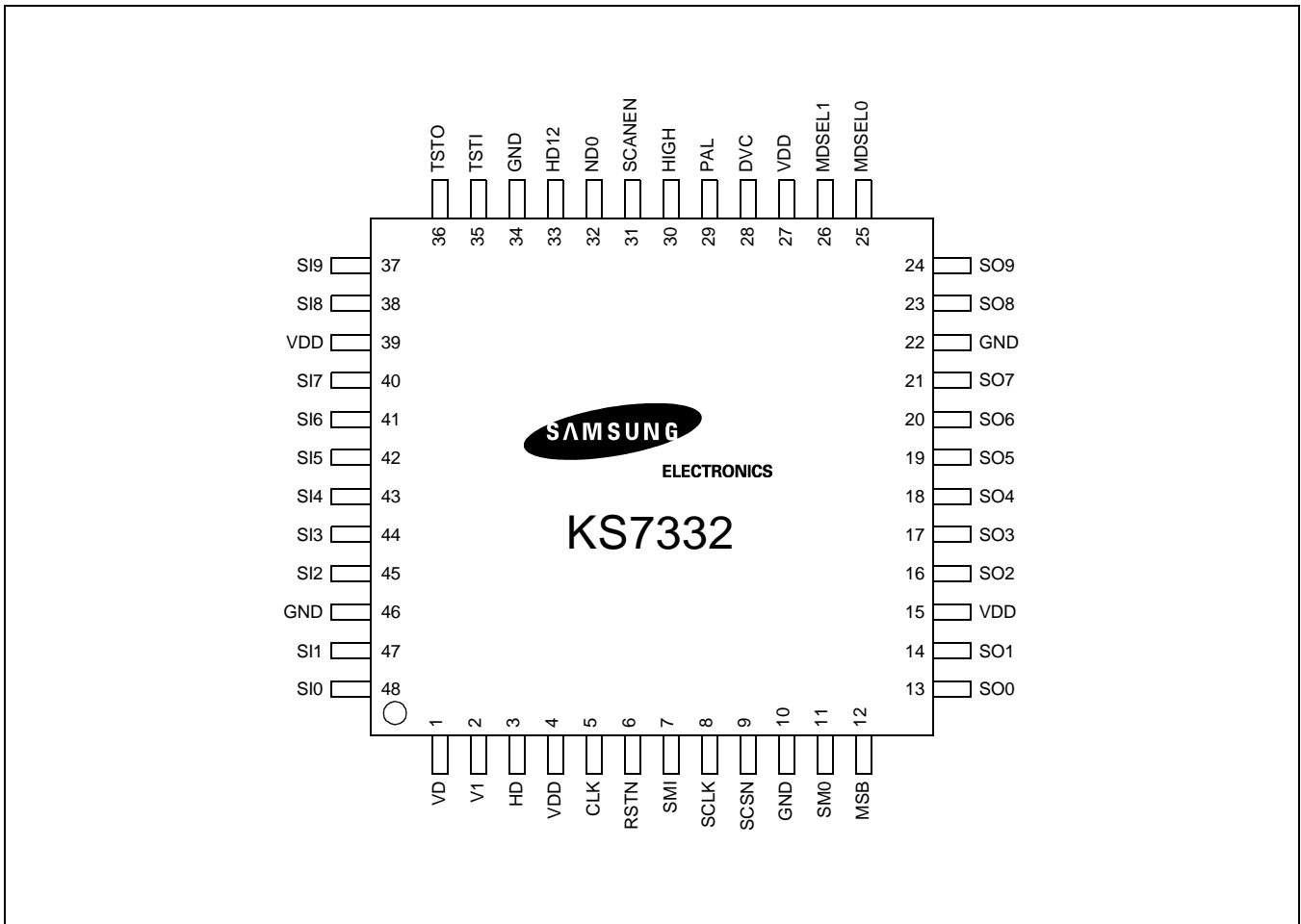

Figure 1. Pin Diagram

PIN DESCRIPTION

Table 1. Pin Description

No	Name	I/O	Description	Note
1	VD	I	Vertical driving pulse	CCD
2	V1	I	Vertical transfer pulse	
3	HD	I	horizontal driving pulse	
4	VDD	P	Power	3.3 V
5	CLK	I	System clock	ADCK (KS7331)
6	RSTN	I	System reset	
7	SMI	I	Serial data input from system micom	
8	SCLK	I	System micom clock	
9	SCSN	I	System micom reset	
10	GND	P	Ground	
11	SMO	O	Serial data output to system micom	TRI-State out Scsn low ACT.
12	MSB	I	Micom data MSB order	"1" MSB first "0" LSB first
13	SO0	O	S1S2 data output 0 for DCP	
14	SO1	O	S1S2 data output 1 for DCP	
15	VDD	P	Power	
16	SO2	O	S1S2 data output 2 for DCP	
17	SO3	O	S1S2 data output 3 for DCP	
18	SO4	O	S1S2 data output 4 for DCP	
19	SO5	O	S1S2 data output 5 for DCP	
20	SO6	O	S1S2 data output 6 for DCP	
21	SO6	O	S1S2 data output 7 for DCP	
22	GND	P	Ground	
23	SO8	O	S1S2 data output 8 for DCP	
24	SO9	O	S1S2 data output 9 for DCP	
25	MDSEL0	I	Operation mode selection 0	Normal "0"
26	MDSEL1	I	Operation mode selection 1	Normal "0"
27	VDD	P	Power	
28	DVC	I	DVC mode enable signal	DVC "1" 8mm "0"
29	PAL	I	PAL mode enable signal	PAL "1" NTSC "0"
30	HIGH	I	High mode enable signal	High "1" Normal "0"
31	SCANEN	I	Scan enable signal	Normal "0"
32	NDO	O	Namd tree output	

Table 1. Pin Description(Continued)

No	Name	I/O	Description	Note
33	HD12	O	HD delay output	
34	GND	P	Ground	
35	TSTI	I	Test input	
36	TSTO	O	Test output	
37	SI9	I	S1S2 data input 9 from ADC	
38	SI8	I	S1S2 data input 8 from ADC	
39	VDD	P	Power	
40	SI7	I	S1S2 data input 7 from ADC	
41	SI6	I	S1S2 data input 6 from ADC	
42	SI5	I	S1S2 data input 5 from ADC	
43	SI4	I	S1S2 data input 4 from ADC	
44	SI3	I	S1S2 data input 3 from ADC	
45	SI2	I	S1S2 data input 2 from ADC	
46	GND	P	Ground	
47	SI1	I	S1S2 data input 1 from ADC	
48	SI0	I	S1S2 data input 0 from ADC	

BLOCK DIAGRAM

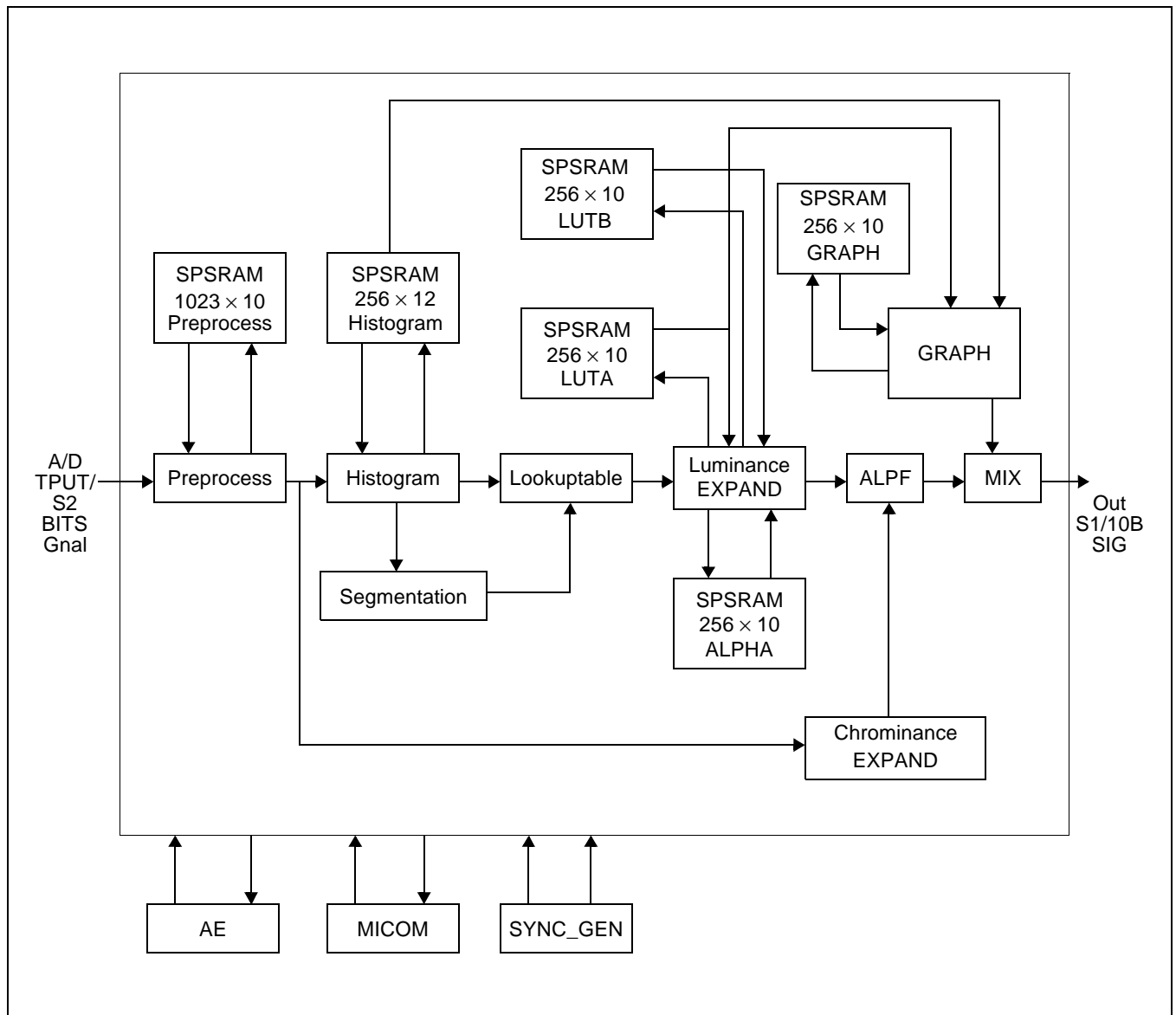

Figure 2. Block Diagram

DESIGN CHARACTERISTICS

ABSOLUTE MAXIMUM RATINGS

Table 2. Absolute Maximum Ratings

Item	Symbol	Rating	Unit	Remark
DC supply voltage (digital)	V_{DD}	-0.3 ~ 3.8	V	-
DC input voltage	V_{IN}	-0.3 ~ $V_{DD} + 0.3$	V	-
Storage temperature	T_{STG}	-40 ~ 125	°C	-
Latch-up current	I_{LU}	±100	mA	-

OPERATING TEMPERATURE

KS7332 functions within 0 °C ~ +70°C Its AC and DC characteristics must satisfy specifications.

ELECTROSTATIC CHARACTERISTICS

Table 3. Electrostatic Characteristics

Item	Electrostatic Standard		Unit	Remark
	Pin No	Design Goal		
Human body model (HBM)	All	±2000	V	
Machine model (MM)		±300		
CDM		±800		

ELECTRICAL CHARACTERISTICS (DC) $V_{SS} = 0V$, $V_{DD} = 3.3 \pm 0.3V$, $T_a = 0 \sim 70 \text{ °C}$

Table 4. Electrical Characteristics (DC)

Item	Symbol	Condition	Min	Typ	Max	Unit	Remark	
Supply voltage	V_{DD}	-	3.0	3.3	3.6	V	V_{DD} , V_{DDA}	
Input voltage	High level	V_{IH}	2.0	-	-		1	
	Low level	V_{IL}	-	-	0.8			
Output voltage	High level	V_{OH}	$I_{OH} = -1mA$	2.4	-	-	2	
	Low level	V_{OL}	$I_{OL} = 1mA$	-	-	0.4		
Input current	High level	I_{IH}	$V_{IN} = V_{DD}$	-10	-	10	μA	1
	Low level	I_{IL}	$V_{IN} = V_{SS}$	-10	-	10		
Output leakage current	Tri-state	I_{OZ}	$V_{OUT} = V_{SS}$ or V_{DD}	-10	-	10	μA	3
Operating current	I_{DD}	-	-	-	70	mA	-	
Static current	I_{SS}	-	-	-	500	μA	-	

[REMARK]

- 1: All Input pins
- 2: All output pins except 3
- 3: SMO (Tri-state)

ELECTRICAL CHARACTERISTICS (AC)

Table 5. Electrical Characteristics (AC)

Item	Signal	Symbol	Design Goal Characteristics			Unit	Remark
			Min	Typ	Max		
Input data setup time	I9 ~ SI0, HD, VD	Tsu	5	-	-	ns	$V_{DD} = 3.3V \pm 0.3V$ $T_a = 0 \sim 70 \text{ }^\circ\text{C}$
Input data hold time	SI9 ~ SI0, HD, VD	Thd	5	-	-	ns	$V_{DD} = 3.3V \pm 0.3V$ $T_a = 0 \sim 70 \text{ }^\circ\text{C}$

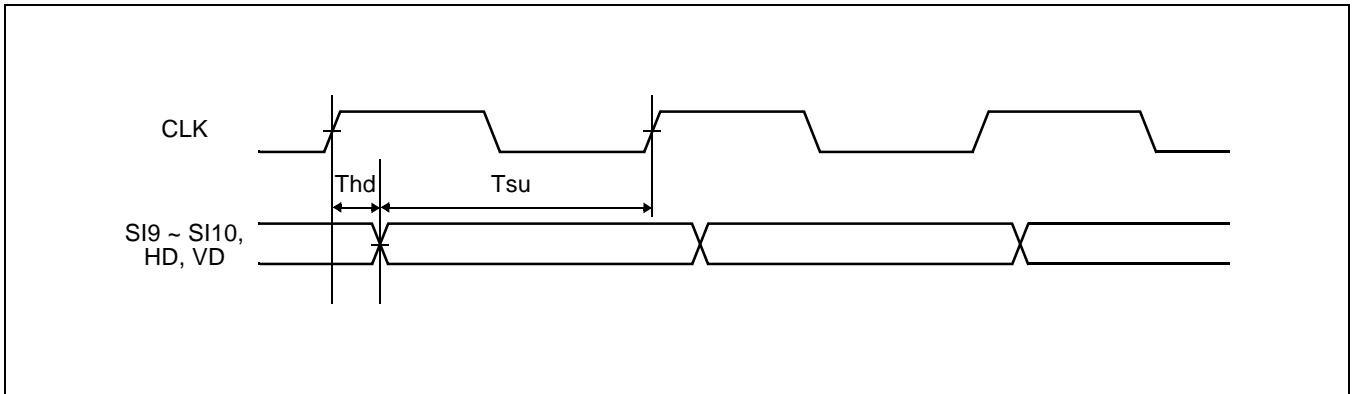

SYSTEM CONFIGURATION AND OPERATION DESCRIPTION

SYSTEM CONFIGURATION

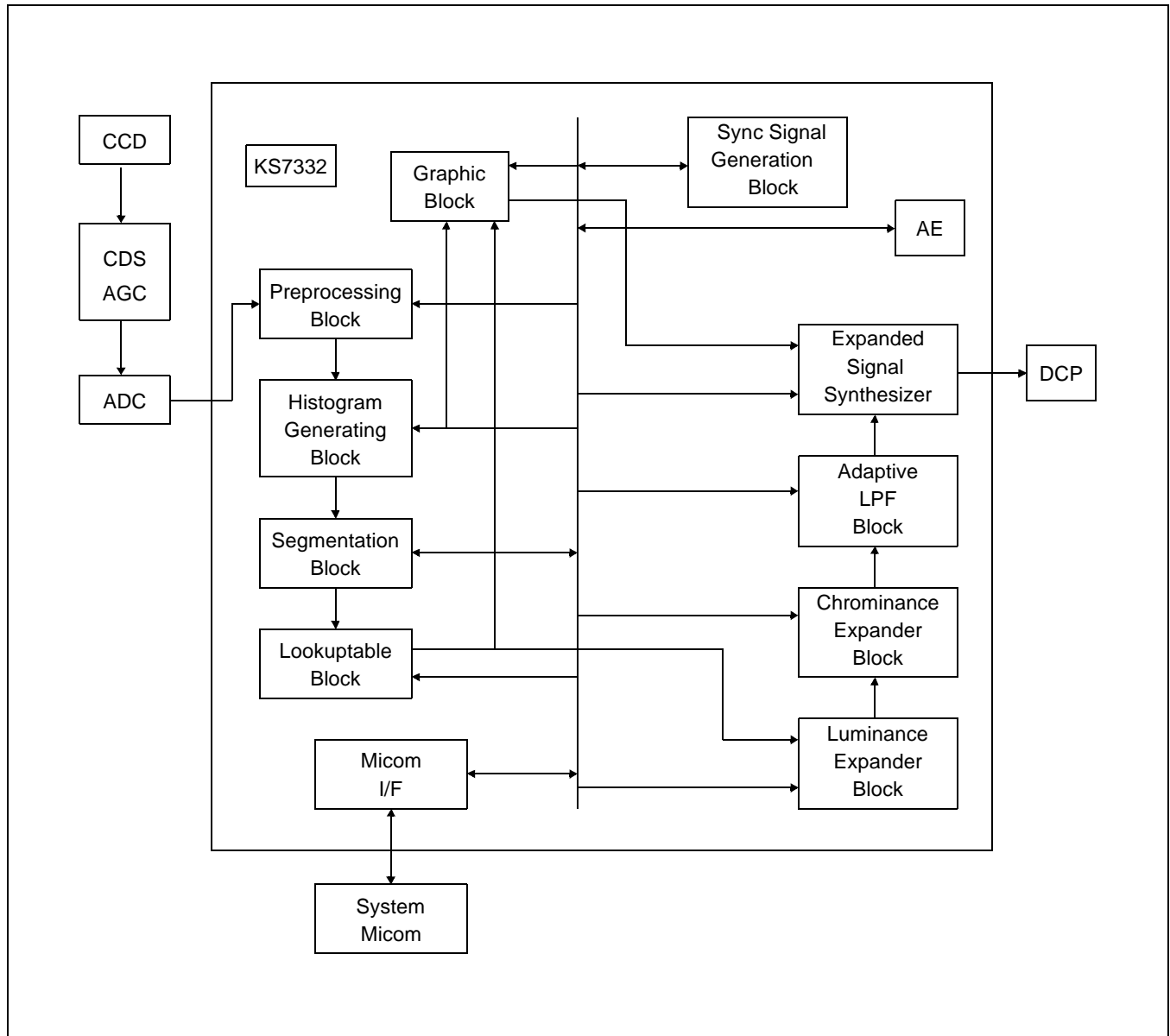

Figure 3. System Configuration

The preprocessing block receives the 10-bit ADC output, carries out digital clamping, black line detection & correction, and preprocess low pass filtering.

The histogram generating block uses the preprocessing block's output to generate a probability density function of the image signal luminance output, and stores it in line memory. It also generates a signal for adjusting luminance distribution and sends it to the segmentation block and the look-up-table generating block. The histogram generating block is composed of the active area selection block, luminance signal separation block that uses LPF, histogram accumulation block that uses line memory, and the histogram clip block.

The segmentation block uses the accumulated histogram to generate back bias impressing conditions and sends them to the MICOM I/F module for improvement of the dynamic range. The segmentation block is composed of a histogram organizing block, histogram integrating block, gamma adjusting block, back bias adjusting block, and a block that probes the minimum segment using accumulated histograms.

The look-up-table block uses the output of the histogram generating block and the segmentation block to generate a conversion function for the improvement of the dynamic range. It is composed of the histogram integrating block, the look-up-table generating block, and the look-up-table 2nd differentiation.

The luminance expander receives the LUT value from the look-up-table block and stores it in line memory. It also moves the address by 1 and stores it in a different line memory. The LUT values stored in the two line memories go through spatial and temporal interpolation to receive data with an expanded band zone for luminance signals. The luminance expander is composed of blocks that carry out the following functions: I/F function for LUT-storing line Memory, temporal interpolation function, spatial interpolation function, 8-bit division function for gain calculation, and expanded luminance signal output function.

The chrominance expander receives the outputs of the preprocessing block and the luminance expander, adjusts the color difference signal according to the ratio between the expanded and the non-expanded luminance signals, and outputs the expanded chrominance signal. It also adjusts the color data's sensitivity according to the the band zone of the luminance signal.

The adaptive LPF block receives the output of the chrominance expander, reduces the high frequency components such as noise in areas with little change in the grey level, and emphasizes edge and other minute details. It also uses a high pass filter to extract the edge of the image.

The graphic block receives the accumulated histogram and LUT data, and shows them as graphic data on the currently visible screen. Also, the graphic data is placed in the middle of the screen while 10-bit A/D signals, expanded brightness signals, expanded color signals, edge signals, and noiseless color signals are output to the background according to need.

The expanded signal synthesizer receives 10-bit A/D signals, expanded luminance signals, expanded color signals, edge signals, and noiseless color signals. It chooses the needed signals and outputs them to the exterior. It also carries out time delay for each signal so that it has the same delay as the final output.

SYSTEM OPERATION DESCRIPTION

Sync Signal Generating Block

The sync signal generating block generates horizontal/vertical count data using the sync signal from the Timing Generator (TG). It also generates SP (Start Point) data using DVC, HIGH, PAL, and AP_ADJ (Start Point Adjustment) from System MICOM, and FLD (Field) signals using HD, VD, and PAL signals.

- Internal vertical counter (VCNT: line counter)
- Internal horizontal counter (HCNT: pixel counter)
- Internal field signal (FLD)
- Internal horizontal active area signal (HACTIVE)
- Internal vertical active area signal (VACTIVE)

Preprocessing Block

The preprocessing block uses the CCD's A/D output to carry out digital clamping, black line detection & correction, and preprocess low pass filtering, then outputs to the histogram generating block.

- Digital clamping
- Black line detection & correction
- Preprocess low pass filtering

Histogram Generating Block

The histogram generating block uses the output from the preprocessing block to generate a probability density function for the video signal's luminance output and stores it in line memory. A signal for luminance distribution adjustment is generated and sent to the segmentation block and look-up-table block.

- ACTIVE Area Selection
- Luminance Signal Separation using LPF
- Histogram Accumulation using Line Memory
- Histogram Clip feature

Segmentation Block

The segmentation block uses the accumulated histogram from the histogram generating block for the improvement of dynamic range. back bias impressing conditions are generated and sent to the look-up-table block and the MICOM I/F module.

- Histogram segmentation
- Histogram integration
- Histogram minimum section probing feature
- Gamma control
- Back bias adjustment

Look-Up-Table Block

The look-up-table block uses the output of the histogram generating block and the segmentation block to generate a conversion function for the improvement of dynamic range. It is composed of the histogram integrating block, look-up-table generating block, and the look-up-table 2nd differentiation.

- Histogram Integration
- Look-Up-Table Generating ability
- Look-Up-Table 2nd Differentiation

Luminance Expander

The luminance expander receives the LUT value from the look-up-table block and stores it in line memory. It also moves the address by 1 and stores it in a different line memory. The LUT values stored in the two line memories are put through temporal and spatial interpolation to receive data with an expanded band zone for luminance signals.

- Line memory I/F function for look-up-table value storage
- Temporal interpolation
- Spatial interpolation
- 8-bit division for gain calculation
- Expanded luminance signal output feature

Chrominance Expander

The chrominance expander receives the outputs of the preprocessing block and the luminance expander, adjusts the color difference signal according to the ratio between the expanded and non-expanded luminance signals, and outputs the expanded chrominance signal. It also adjusts the color data's sensitivity according to the the band zone of the luminance signal.

- Color difference signal adjustment according to ratio between expanded and non-expanded luminance signals
- Color data sensitivity adjustment according to luminance signal band zone

Adaptive LPF Block

The adaptive LPF block receives the output of the chrominance expander, reduces high frequency components such as noise in areas with little change in the grey level, and emphasizes edge and other minute details. It also uses a high pass filter to extract the edge of the image.

- Horizontal signal delay
- Weight calculation of neighboring picture element pixels
- Adaptive noise elimination
- Edge emphasis and extraction

Graphic Block

The graphic block receives the accumulated histogram and LUT data, and shows them as graphic data on the currently visible screen. Also, the graphic data is placed in the middle of the screen while 10-bit A/D signals, expanded luminance signals, expanded color signals, edge signals, and noiseless color signals are output to the background according to need.

- Fixing graphic data to the middle
- Graphic data output
- Background screen selection output
- Graphic data status selection

Expanded Signal Synthesizer

The expanded signal synthesizer receives 10-bit A/D signals, expanded luminance signals, expanded color signals, edge signals, and noiseless color signals. It chooses the needed signals and outputs them to the exterior. It also carries out time delay for each signal so that it has the same delay as the final output.

- 10-bit A/D signal input feature
- Expanded luminance signal input feature
- Expanded color signal input feature
- Edge signal input feature
- Noiseless color signal input feature
- Selective input signal output
- Input signal delay feature

MICOM REGISTER TABLE

OPERATION DESCRIPTION

The start signal and clock operate in slave mode, so this part is nonsynchronous to the rest of the system. The register setting is normally carried out for all segments within the field, and it is latched at negedge VD when scsn is restored to high.

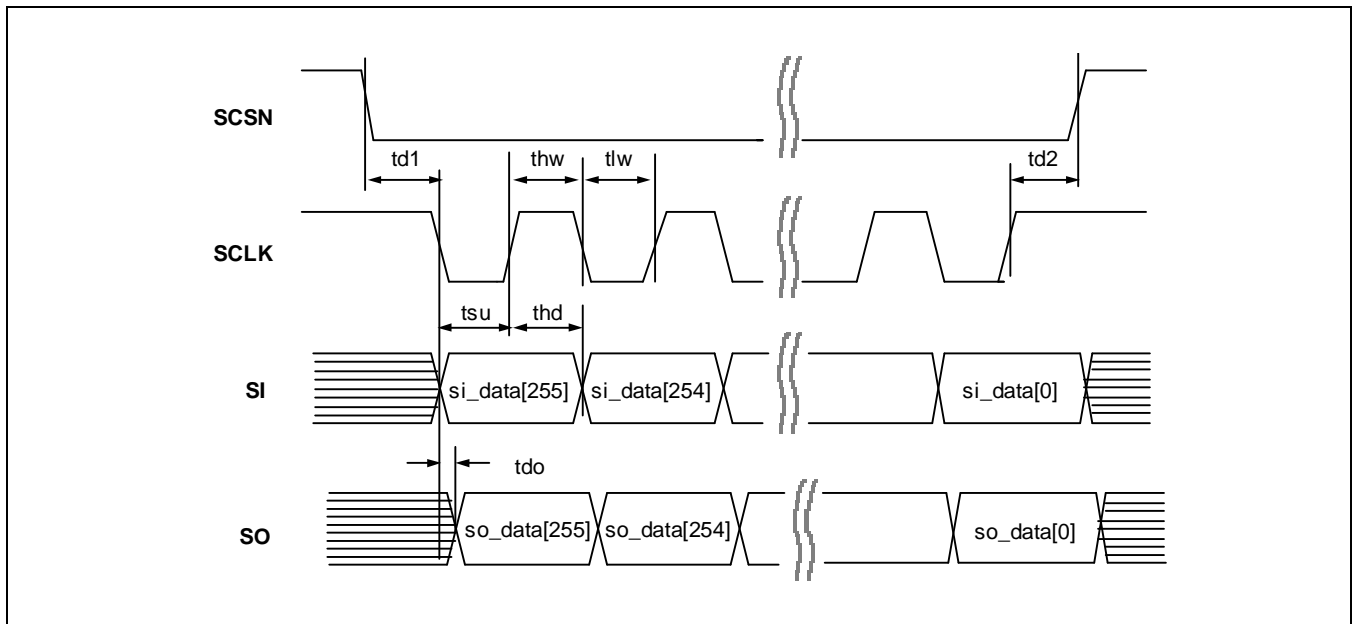

Figure 4. Operation Description

Symbol	Description	Standard (ns)	
		min	max
td1	SCSN low edge to SCLK low edge	0.2	-
td2	SCLK high edge to SCSN high edge	0.2	-
thw	SCLK high width	0.2	-
tlw	SCLK low width	0.2	-
tsu	SI data setup time	0.2	-
thd	SI data hold time	0.2	-
tdo	SO data out delay time	-	0.1

MICOM INPUT

Table 6. Micom Input

Register Bits	MICOM Command	Default Value																
	Function																	
[255:248]	OUT_MODE [2:0], DLY_MODE [4:0]	1 1 1 1 _ 0 0 0 1																
	OUT_MODE: Output mode selection																	
	<table border="1"> <thead> <tr> <th>OUT_MODE</th> <th>MODE</th> </tr> </thead> <tbody> <tr> <td>0 0 0</td> <td>Input</td> </tr> <tr> <td>0 0 1</td> <td>Preprocess module output</td> </tr> <tr> <td>0 1 0</td> <td>WDR output</td> </tr> <tr> <td>0 1 1</td> <td>Saturation output</td> </tr> <tr> <td>1 0 0</td> <td>Graphic output</td> </tr> <tr> <td>1 0 1</td> <td>EDGE output</td> </tr> <tr> <td>Default</td> <td>WDR + saturation + ALPF output</td> </tr> </tbody> </table>		OUT_MODE	MODE	0 0 0	Input	0 0 1	Preprocess module output	0 1 0	WDR output	0 1 1	Saturation output	1 0 0	Graphic output	1 0 1	EDGE output	Default	WDR + saturation + ALPF output
	OUT_MODE	MODE																
	0 0 0	Input																
	0 0 1	Preprocess module output																
	0 1 0	WDR output																
	0 1 1	Saturation output																
	1 0 0	Graphic output																
	1 0 1	EDGE output																
Default	WDR + saturation + ALPF output																	
DLY_MODE: Output delay mode selection																		
- For matching output's delay																		
<table border="1"> <thead> <tr> <th>DLY_MODE</th> <th>MODE</th> </tr> </thead> <tbody> <tr> <td>0 0 0 0 0</td> <td>No delay</td> </tr> <tr> <td>0 0 0 0 1</td> <td>1 clock delay</td> </tr> <tr> <td>0 0 0 1 0</td> <td>2 clock delay</td> </tr> <tr> <td></td> <td></td> </tr> <tr> <td>1 0 1 0 0</td> <td>20 clock delay</td> </tr> <tr> <td>Default</td> <td>21 clock delay</td> </tr> </tbody> </table>		DLY_MODE	MODE	0 0 0 0 0	No delay	0 0 0 0 1	1 clock delay	0 0 0 1 0	2 clock delay			1 0 1 0 0	20 clock delay	Default	21 clock delay			
DLY_MODE	MODE																	
0 0 0 0 0	No delay																	
0 0 0 0 1	1 clock delay																	
0 0 0 1 0	2 clock delay																	
1 0 1 0 0	20 clock delay																	
Default	21 clock delay																	

Table 6. Micom Input(Continued)

Register Bits	MICOM Command	Default Value															
	Function																
[247:240]	CLPEN, SORSL, V1_EXIST, GR_MODE [1:0], GRB_MODE [2:0]	1 1 1 X _ X X X X															
	<table border="1" style="width: 100%; border-collapse: collapse;"> <tr> <td style="width: 20%;">CLPEN</td> <td style="width: 20%;">SORSL</td> <td style="width: 20%;">V1_EXIST</td> <td style="width: 20%;">GR_MODE [1:0]</td> <td style="width: 20%;">GRB_MODE [2:0]</td> </tr> </table>		CLPEN	SORSL	V1_EXIST	GR_MODE [1:0]	GRB_MODE [2:0]										
	CLPEN	SORSL	V1_EXIST	GR_MODE [1:0]	GRB_MODE [2:0]												
	<p> .. CLPEN: On/off of digital clamp operation; on = '1', off = '0' ! SORSL: On/off of preprocess LPF operation; on = '0', off = '1' Æ V1_EXIST: V1 signal existence; yes = '0', no = '1' Ø GR_MODE: Graphic mode - GR_MODE[0]: Histogram CLIP feature (DO_HIST >> GR_MODE[0]) - GR_MODE[1]: DOT/White graphic selection feature DOT = '1', WHITE = '0' × GRB_MODE : Background screen in graphic mode </p>																
<table border="1" style="width: 100%; border-collapse: collapse;"> <thead> <tr> <th style="width: 50%;">GRB_MODE</th> <th style="width: 50%;">MODE</th> </tr> </thead> <tbody> <tr> <td>0 0 0</td> <td>Black</td> </tr> <tr> <td>0 0 1</td> <td>Input</td> </tr> <tr> <td>0 1 0</td> <td>Preprocess module output</td> </tr> <tr> <td>0 1 1</td> <td>WDR output</td> </tr> <tr> <td>1 0 0</td> <td>Saturation output</td> </tr> <tr> <td>1 0 1</td> <td>EDGE output</td> </tr> <tr> <td>Default</td> <td>WDR + saturation + ALPF output</td> </tr> </tbody> </table>		GRB_MODE	MODE	0 0 0	Black	0 0 1	Input	0 1 0	Preprocess module output	0 1 1	WDR output	1 0 0	Saturation output	1 0 1	EDGE output	Default	WDR + saturation + ALPF output
GRB_MODE	MODE																
0 0 0	Black																
0 0 1	Input																
0 1 0	Preprocess module output																
0 1 1	WDR output																
1 0 0	Saturation output																
1 0 1	EDGE output																
Default	WDR + saturation + ALPF output																
[239:232]	CMP_ADJ [3:0], SP_ADJ [3:0]	0 0 0 0 _ 0 0 0 0															
	<p> - CMP_ADJ: Digital clamp operating range adjustment - SP_SDJ: Starting point adjustment of horizontal active area selection for AE </p>																
[231:224]	POFFSET [7:0]	0 0 0 0 _ 0 0 0 0															
	<p style="text-align: center;"> <table border="1" style="width: 100%; border-collapse: collapse;"> <tr> <td style="width: 100%; text-align: center;">POFFSET [7:0]</td> </tr> </table> </p> <p>- POFFSET: Used when adding or subtracting the OFFSET to the 8 picture element pixels, integrated and averaged over TCLP</p>		POFFSET [7:0]														
POFFSET [7:0]																	
[223:216]	SP_H [7:0]	0 0 0 1 _ 1 0 0 1															
	<p style="text-align: center;"> <table border="1" style="width: 100%; border-collapse: collapse;"> <tr> <td style="width: 100%; text-align: center;">SP_H [7:0]</td> </tr> </table> </p> <p>- Horizontal active starting point for active area selection = SP_H << 2</p>		SP_H [7:0]														
SP_H [7:0]																	

Table 6. Micom Input(Continued)

Register Bits	MICOM Command	Default Value										
[215:208]	LP_H [7:0]	0 1 1 1 _ 1 1 0 1										
	<div style="border: 1px solid black; width: 100%; height: 20px; margin-bottom: 5px;"></div> LP_H [7:0]											
	- Horizontal active starting point for active area selection = LP_H << 2											
[207:200]	SP_V [7:0]	0 0 0 1 _ 0 1 0 0										
	<div style="border: 1px solid black; width: 100%; height: 20px; margin-bottom: 5px;"></div> LP_H [7:0]											
	- Vertical active starting point for active area selection											
[199:192]	LP_V [7:0]	1 1 1 1 _ 0 0 0 0										
	<div style="border: 1px solid black; width: 100%; height: 20px; margin-bottom: 5px;"></div> LP_V [7:0]											
	- Vertical active starting point for active area selection											
[191:184]	EDGE_AMP [3:0], BACK_SP [3:0]	0 0 0 0 _ 0 0 0 0										
	<div style="display: flex; justify-content: space-around; border: 1px solid black; padding: 5px;"> <div style="border: 1px solid black; width: 45%; height: 20px; margin-bottom: 5px;"></div> <div style="border: 1px solid black; width: 45%; height: 20px; margin-bottom: 5px;"></div> </div> EDGE_AMP [3:0] BACK_SP [3:0]											
	** EDGE_AMP: EDGE amplification ratio † BACK_SP: Back bias allocation conditions											
<table border="1" style="width: 100%; border-collapse: collapse;"> <thead> <tr> <th style="width: 50%;">BACK_SP</th> <th style="width: 50%;">MODE</th> </tr> </thead> <tbody> <tr> <td style="text-align: center;">0000</td> <td>No back bias</td> </tr> <tr> <td style="text-align: center;">0001 - 1000</td> <td>BACK_SP ⁽¹⁾</td> </tr> <tr> <td style="text-align: center;">1111</td> <td>Reserved ⁽²⁾</td> </tr> <tr> <td style="text-align: center;">Default</td> <td>Reserved</td> </tr> </tbody> </table>			BACK_SP	MODE	0000	No back bias	0001 - 1000	BACK_SP ⁽¹⁾	1111	Reserved ⁽²⁾	Default	Reserved
BACK_SP	MODE											
0000	No back bias											
0001 - 1000	BACK_SP ⁽¹⁾											
1111	Reserved ⁽²⁾											
Default	Reserved											
NOTES: 1. Given value between 1 ~ 8 2. Back-bias point from hlog value												

Table 6. Micom Input(Continued)

Register Bits	MICOM Command	Default Value
[183:176]	BACK_WT [3:0], HIST_WT [3:0]	0 0 0 0 _ 1 0 0 0
	<div style="display: flex; justify-content: space-around; border: 1px solid black; padding: 5px;"> EDGE_AMP [3:0] BACK_SP [3:0] </div> <p>BACK_WT: Back bias weight</p>  <p>HIST_WT: Histogram equalization and bypass weight (0 ~ 15)</p> 	
[175:168]	LUT_GAIN [7:0]	0 1 0 0 _ 0 0 0 0
	<div style="border: 1px solid black; padding: 5px; margin-bottom: 10px;">LUT_GAIN [7:0]</div> <ul style="list-style-type: none"> - Gain that makes the maximum LUT value = 1023 - $LUT_GAIN = 2^{22} / (LP_H \times LP_V)$ If 64 when Image area size is 256 X 256, maximum LUT value is 1023 	

Table 6. Micom Input(Continued)

Register Bits	MICOM Command	Default Value																
	Function																	
[167:160]	LTI_ON, LSI_ON, LUT_TAB [2:0], LUT_HPF_SFT [2:0]	1 1 1 0 _ 0 0 1 0																
	<table border="1" data-bbox="368 501 1394 544"> <tr> <td>LTI_ON</td> <td>LSI_ON</td> <td>LUT_TAB [2:0]</td> <td>LUT_HPF_SFT [2:0]</td> </tr> </table> <p data-bbox="352 566 836 636">LTI_ON: Temporal interpolation for LUT on = '1', off = '0'</p> <p data-bbox="352 640 804 710">LSI_ON: Spatial interpolation for LUT on = '1', off = '0'</p> <p data-bbox="352 714 1190 748">LUT_TAB: TAB adjustment for LUT 2nd differentiation compensation</p> <table border="1" data-bbox="368 786 1230 1043"> <thead> <tr> <th>LUT_TAB</th> <th>MODE</th> </tr> </thead> <tbody> <tr> <td>001</td> <td>±1 TAB</td> </tr> <tr> <td>010</td> <td>±2 TAB</td> </tr> <tr> <td>011</td> <td>±3 TAB</td> </tr> <tr> <td>100</td> <td>±4 TAB</td> </tr> <tr> <td>Default</td> <td>0 TAB</td> </tr> </tbody> </table> <p data-bbox="352 1077 1114 1182">LUT_HPF_SFT: - LUT 2nd differentiation compensation gain - Noise reduction by relieving sudden temporal noise generator</p>		LTI_ON	LSI_ON	LUT_TAB [2:0]	LUT_HPF_SFT [2:0]	LUT_TAB	MODE	001	±1 TAB	010	±2 TAB	011	±3 TAB	100	±4 TAB	Default	0 TAB
LTI_ON	LSI_ON	LUT_TAB [2:0]	LUT_HPF_SFT [2:0]															
LUT_TAB	MODE																	
001	±1 TAB																	
010	±2 TAB																	
011	±3 TAB																	
100	±4 TAB																	
Default	0 TAB																	
[159:152]	LTIC [3:0], CH_SEL [3:0]	0 0 0 0 _ 1 0 0 0																
	<table border="1" data-bbox="368 1279 1321 1321"> <tr> <td>LTIC [3:0]</td> <td>CH_SEL [3:0]</td> </tr> </table> <p data-bbox="352 1344 1422 1480">LTIC: - Temporal interpolation coefficient for LUT. Prevents LUT from changing suddenly over time. - If TIC is closer to 0, follow the current LUT, and if closer to 255, follow the previous LUT.</p> <div data-bbox="507 1525 1246 1816">  <p data-bbox="587 1787 735 1816">Without LTIC</p> <p data-bbox="1002 1787 1118 1816">With LTIC</p> </div>		LTIC [3:0]	CH_SEL [3:0]														
LTIC [3:0]	CH_SEL [3:0]																	

Table 6. Micom Input(Continued)

Register Bits	MICOM Command	Default Value																																																																																							
	Function																																																																																								
[159:152]	CH_SEL: Chroma LPF selection																																																																																								
	<table border="1" style="width: 100%; border-collapse: collapse;"> <thead> <tr> <th data-bbox="400 479 780 517" style="text-align: center;">CH_SEL</th> <th colspan="6" data-bbox="780 479 1287 517" style="text-align: center;">MODE</th> </tr> <tr> <td></td> <th data-bbox="842 517 904 555" style="text-align: center;">S1</th> <th data-bbox="904 517 967 555" style="text-align: center;">S2</th> <th data-bbox="967 517 1029 555" style="text-align: center;">S1</th> <th data-bbox="1029 517 1091 555" style="text-align: center;">S2</th> <th data-bbox="1091 517 1153 555" style="text-align: center;">S1</th> <th data-bbox="1153 517 1216 555" style="text-align: center;">S2</th> </tr> </thead> <tbody> <tr> <td data-bbox="400 555 780 593" style="text-align: center;">0 0 0 0</td> <td data-bbox="780 555 842 593" style="text-align: center;">[</td> <td data-bbox="842 555 904 593" style="text-align: center;">-1</td> <td data-bbox="904 555 967 593" style="text-align: center;">1</td> <td data-bbox="967 555 1029 593"></td> <td data-bbox="1029 555 1091 593"></td> <td data-bbox="1091 555 1153 593" style="text-align: center;">]/</td> <td data-bbox="1153 555 1216 593" style="text-align: center;">2</td> </tr> <tr> <td data-bbox="400 593 780 631" style="text-align: center;">0 0 0 1</td> <td data-bbox="780 593 842 631" style="text-align: center;">[</td> <td data-bbox="842 593 904 631"></td> <td data-bbox="904 593 967 631"></td> <td data-bbox="967 593 1029 631" style="text-align: center;">1</td> <td data-bbox="1029 593 1091 631" style="text-align: center;">-1</td> <td data-bbox="1091 593 1153 631" style="text-align: center;">]/</td> <td data-bbox="1153 593 1216 631" style="text-align: center;">2</td> </tr> <tr> <td data-bbox="400 631 780 669" style="text-align: center;">0 0 1 0</td> <td data-bbox="780 631 842 669" style="text-align: center;">[</td> <td data-bbox="842 631 904 669" style="text-align: center;">1</td> <td data-bbox="904 631 967 669" style="text-align: center;">-2</td> <td data-bbox="967 631 1029 669" style="text-align: center;">1</td> <td data-bbox="1029 631 1091 669"></td> <td data-bbox="1091 631 1153 669" style="text-align: center;">]/</td> <td data-bbox="1153 631 1216 669" style="text-align: center;">4</td> </tr> <tr> <td data-bbox="400 669 780 707" style="text-align: center;">0 0 1 1</td> <td data-bbox="780 669 842 707" style="text-align: center;">[</td> <td data-bbox="842 669 904 707" style="text-align: center;">-1</td> <td data-bbox="904 669 967 707" style="text-align: center;">2</td> <td data-bbox="967 669 1029 707" style="text-align: center;">-1</td> <td data-bbox="1029 669 1091 707"></td> <td data-bbox="1091 669 1153 707" style="text-align: center;">]/</td> <td data-bbox="1153 669 1216 707" style="text-align: center;">4</td> </tr> <tr> <td data-bbox="400 707 780 745" style="text-align: center;">0 1 0 0</td> <td data-bbox="780 707 842 745" style="text-align: center;">[</td> <td data-bbox="842 707 904 745"></td> <td data-bbox="904 707 967 745" style="text-align: center;">1</td> <td data-bbox="967 707 1029 745" style="text-align: center;">-2</td> <td data-bbox="1029 707 1091 745" style="text-align: center;">-1</td> <td data-bbox="1091 707 1153 745" style="text-align: center;">]/</td> <td data-bbox="1153 707 1216 745" style="text-align: center;">4</td> </tr> <tr> <td data-bbox="400 745 780 784" style="text-align: center;">0 1 0 1</td> <td data-bbox="780 745 842 784" style="text-align: center;">[</td> <td data-bbox="842 745 904 784" style="text-align: center;">1</td> <td data-bbox="904 745 967 784" style="text-align: center;">-1</td> <td data-bbox="967 745 1029 784" style="text-align: center;">1</td> <td data-bbox="1029 745 1091 784" style="text-align: center;">-1</td> <td data-bbox="1091 745 1153 784" style="text-align: center;">]/</td> <td data-bbox="1153 745 1216 784" style="text-align: center;">4</td> </tr> <tr> <td data-bbox="400 784 780 822" style="text-align: center;">0 1 1 0</td> <td data-bbox="780 784 842 822" style="text-align: center;">[</td> <td data-bbox="842 784 904 822" style="text-align: center;">-1</td> <td data-bbox="904 784 967 822" style="text-align: center;">1</td> <td data-bbox="967 784 1029 822" style="text-align: center;">-1</td> <td data-bbox="1029 784 1091 822" style="text-align: center;">1</td> <td data-bbox="1091 784 1153 822" style="text-align: center;">]/</td> <td data-bbox="1153 784 1216 822" style="text-align: center;">4</td> </tr> <tr> <td data-bbox="400 822 780 860" style="text-align: center;">0 1 1 1</td> <td data-bbox="780 822 842 860" style="text-align: center;">[</td> <td data-bbox="842 822 904 860" style="text-align: center;">-1</td> <td data-bbox="904 822 967 860"></td> <td data-bbox="967 822 1029 860" style="text-align: center;">-1</td> <td data-bbox="1029 822 1091 860" style="text-align: center;">1</td> <td data-bbox="1091 822 1153 860" style="text-align: center;">1</td> <td data-bbox="1153 822 1216 860" style="text-align: center;">]/</td> <td data-bbox="1216 822 1287 860" style="text-align: center;">4</td> </tr> <tr> <td data-bbox="400 860 780 898" style="text-align: center;">Default</td> <td data-bbox="780 860 842 898" style="text-align: center;">[</td> <td data-bbox="842 860 904 898"></td> <td data-bbox="904 860 967 898" style="text-align: center;">1</td> <td data-bbox="967 860 1029 898" style="text-align: center;">-1</td> <td data-bbox="1029 860 1091 898"></td> <td data-bbox="1091 860 1153 898" style="text-align: center;">]/</td> <td data-bbox="1153 860 1216 898" style="text-align: center;">2</td> </tr> </tbody> </table>	CH_SEL	MODE							S1	S2	S1	S2	S1	S2	0 0 0 0	[-1	1]/	2	0 0 0 1	[1	-1]/	2	0 0 1 0	[1	-2	1]/	4	0 0 1 1	[-1	2	-1]/	4	0 1 0 0	[1	-2	-1]/	4	0 1 0 1	[1	-1	1	-1]/	4	0 1 1 0	[-1	1	-1	1]/	4	0 1 1 1	[-1		-1	1	1]/	4	Default	[1	-1]/	2	
	CH_SEL	MODE																																																																																							
		S1	S2	S1	S2	S1	S2																																																																																		
	0 0 0 0	[-1	1]/	2																																																																																	
	0 0 0 1	[1	-1]/	2																																																																																	
	0 0 1 0	[1	-2	1]/	4																																																																																	
	0 0 1 1	[-1	2	-1]/	4																																																																																	
	0 1 0 0	[1	-2	-1]/	4																																																																																	
	0 1 0 1	[1	-1	1	-1]/	4																																																																																	
	0 1 1 0	[-1	1	-1	1]/	4																																																																																	
0 1 1 1	[-1		-1	1	1]/	4																																																																																	
Default	[1	-1]/	2																																																																																		
	Processing point																																																																																								
[151:144]	BOUND0 [7:0]	1 0 0 0 _ 0 0 0 0																																																																																							
	<div style="border: 1px solid black; padding: 5px; text-align: center; margin-bottom: 5px;">BOUND0 [7:0]</div> - BOUND0: changing point value for luminance level 0's CHROMA gain adjustment.																																																																																								
[143:136]	BOUND32 [3:0]	1 0 0 0 _ 0 0 0 0																																																																																							
	<div style="border: 1px solid black; padding: 5px; text-align: center; margin-bottom: 5px;">BOUND32 [7:0]</div> - BOUND32: changing point value for luminance level 32's CHROMA gain adjustment																																																																																								
[135:128]	BOUND64 [3:0]	1 0 0 0 _ 0 0 0 0																																																																																							
	<div style="border: 1px solid black; padding: 5px; text-align: center; margin-bottom: 5px;">BOUND64 [7:0]</div> - BOUND64: changing point value for luminance level 64's CHROMA gain adjustment																																																																																								
[127:120]	BOUND128 [3:0]	1 0 0 0 _ 0 0 0 0																																																																																							
	<div style="border: 1px solid black; padding: 5px; text-align: center; margin-bottom: 5px;">BOUND128 [7:0]</div> - BOUND128: changing point value for luminance level 128's CHROMA gain adjustment																																																																																								

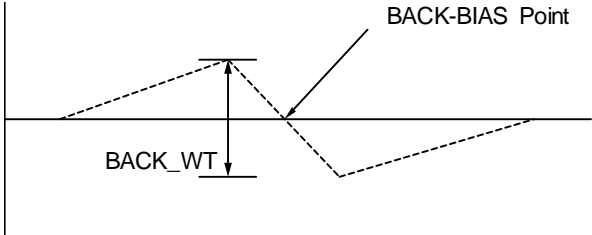
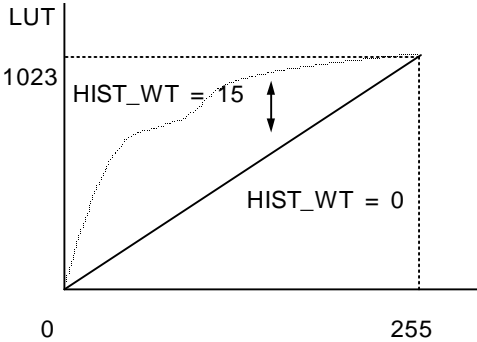
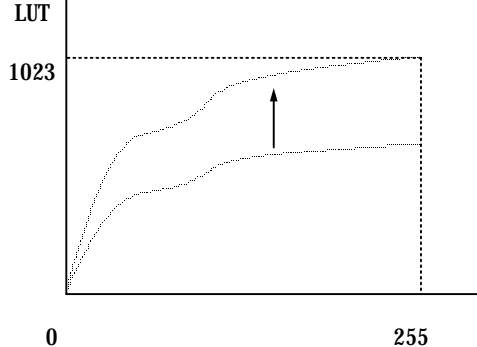
Table 6. Micom Input(Continued)

Register Bits	MICOM Command	Default Value
[119:112]	Function	
	BOUND256 [3:0]	1 0 0 0 _ 0 0 0 0
	<div style="border: 1px solid black; padding: 5px; margin-bottom: 10px; text-align: center;">BOUND256 [7:0]</div> <p>- BOUND256: changing point value for luminance level 256's CHROMA gain adjustment</p>  <p>NOTE: BOUND0, BOUND32, BOUND64, BOUND128, and BOUND256 are for adjusting color signal sensitivity, which strengthens the color suppress of all areas.</p>	
	HLOG_ON, SAT_ON, ALPF_WTSFT [2:0], SHPF_SFT[2:0]	1 1 1 0 _ 0 0 0 1

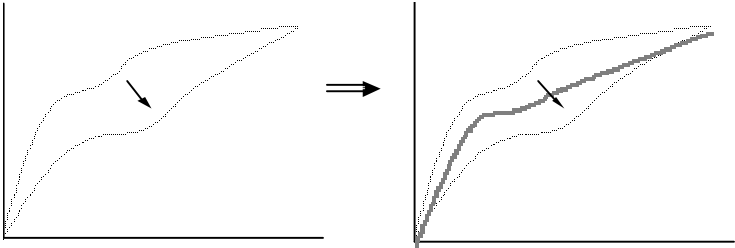
Table 6. Micom Input(Continued)

Register Bits	MICOM Command	Default Value				
	Function					
	<table border="1" style="width:100%; border-collapse: collapse;"> <tr> <td style="width:25%; text-align:center;">HLOG_ON</td> <td style="width:25%; text-align:center;">SAT_ON</td> <td style="width:25%; text-align:center;">ALPF_WTSFT [2:0]</td> <td style="width:25%; text-align:center;">SHPF_SFT[2:0]</td> </tr> </table>	HLOG_ON	SAT_ON	ALPF_WTSFT [2:0]	SHPF_SFT[2:0]	SHPF_SFT[2:0]
HLOG_ON	SAT_ON	ALPF_WTSFT [2:0]	SHPF_SFT[2:0]			
	<p>HLOG_ON:</p> <ul style="list-style-type: none"> - 1: Histogram log accumulation output - 0: LUT control point value output <div style="display: flex; justify-content: space-around; align-items: flex-end;">   </div> <p style="text-align: center;">Histogram LOG Value LUT Changing Point Value Output</p> <p>SAT_ON: Saturation block's on/off ; on = '1', off = '0'</p> <p>ALPF_WTSFT: Gain of slope for ALPF</p>  <p>SHPF_SFT: HPF gain</p>					
[103:96]	ALPF_THP [7:0]	1 0 0 0 _ 0 0 0 0				
	<table border="1" style="width:100%; border-collapse: collapse;"> <tr> <td style="width:100%; text-align:center;">ALPF_THP [7:0]</td> </tr> </table> <p>- ALPF_THP: ALPF threshold</p>		ALPF_THP [7:0]			
ALPF_THP [7:0]						
[95:88]	AEW1HS [7:0]	0 0 1 0 _ 0 0 0 0				
	<table border="1" style="width:100%; border-collapse: collapse;"> <tr> <td style="width:100%; text-align:center;">AEW1HS [7:0]</td> </tr> </table> <p>- Refer to KS7331's DCP ODM block</p>		AEW1HS [7:0]			
AEW1HS [7:0]						

Table 6. Micom Input(Continued)

Register Bits	MICOM Command	Default Value
	Function	
[87:80]	AEW1HE [7:0]	0 0 1 0 _ 1 0 1 0
	<div style="border: 1px solid black; padding: 5px; text-align: center;">AEW1HE [7:0]</div> - Refer to KS7331's DCP ODM block	
[79:72]	AEW1VS [7:0]	0 0 0 1 _ 0 0 0 0
	<div style="border: 1px solid black; padding: 5px; text-align: center;">AEW1VS [7:0]</div> - Refer to KS7331's DCP ODM block	
[71:64]	AEW1VE [7:0]	0 1 0 1 _ 0 0 0 0
	<div style="border: 1px solid black; padding: 5px; text-align: center;">AEW1VE [7:0]</div> - Refer to KS7331's DCP ODM block	
[63:56]	AEW2HS [7:0]	0 0 0 1 _ 0 0 0 0
	<div style="border: 1px solid black; padding: 5px; text-align: center;">AEW2HS [7:0]</div> - Refer to KS7331's DCP ODM block	
[55:48]	AEW2HE [7:0]	1 1 1 1 _ 1 1 1 0
	<div style="border: 1px solid black; padding: 5px; text-align: center;">AEW2HE [7:0]</div> - Refer to KS7331's DCP ODM block	
[47:40]	AEW2VS [7:0]	0 0 0 1 _ 0 0 0 0
	<div style="border: 1px solid black; padding: 5px; text-align: center;">AEW2VS [7:0]</div> - Refer to KS7331's DCP ODM block	
[39:32]	AEW2VE [7:0]	0 1 0 0 _ 0 0 1 0
	<div style="border: 1px solid black; padding: 5px; text-align: center;">AEW2VE [7:0]</div> - Refer to KS7331's DCP ODM block	
[31:24]	AEH_TH [7:0]	1 1 1 1 _ 1 1 1 1
	<div style="border: 1px solid black; padding: 5px; text-align: center;">AEH_TH [7:0]</div> - Refer to KS7331's DCP ODM block	

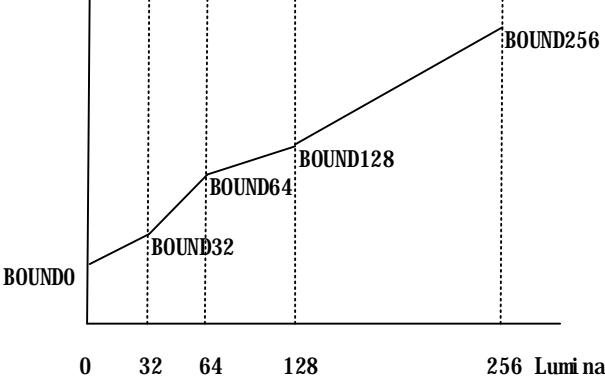
Table 6. Micom Input(Continued)

Register Bits	MICOM Command	Default Value
	Function	
[23:16]	AEL_TH [7:0]	0 0 0 0 _ 0 0 0 0
	<div style="border: 1px solid black; padding: 5px; text-align: center;">AEH_TH [7:0]</div> - Refer to KS7331's DCP ODM block	
[7:0]	AEINSEL, AELPFSEL	1 0 X X _ X X X X
	<div style="border: 1px solid black; padding: 5px; display: flex; justify-content: space-between;"> AEINSEL AELPFSEL X [5:0] </div> - Refer to KS7331's DCP ODM block	
[255:248]	RESERVED [7:0]	1 1 1 1 _ 0 0 0 0
	<div style="border: 1px solid black; padding: 5px; text-align: center;">RESERVED [7:0]</div> - Reserved	
[247:240]	RESERVED [7:0]	0 0 0 0 _ 1 1 1 1
	<div style="border: 1px solid black; padding: 5px; text-align: center;">RESERVED [7:0]</div> - Reserved	
[239:232]	HLOG0 [7:0]	?
	<div style="border: 1px solid black; padding: 5px; text-align: center;">HLOG0 [7:0]</div> - Log scaling and accumulated value for histogram of luminance level 0 ~ 11	
[231:224]	HLOG1 [7:0]	?
	<div style="border: 1px solid black; padding: 5px; text-align: center;">HLOG1 [7:0]</div> - Log scaling and accumulated value for histogram of luminance level 12 ~ 16	
[223:216]	HLOG2 [7:0]	?
	<div style="border: 1px solid black; padding: 5px; text-align: center;">HLOG2 [7:0]</div> - Log scaling and accumulated value for histogram of luminance level 17 ~ 23	
[215:208]	HLOG3 [7:0]	?
	<div style="border: 1px solid black; padding: 5px; text-align: center;">HLOG3 [7:0]</div> - Log scaling and accumulated value for histogram of luminance level 24 ~ 32	

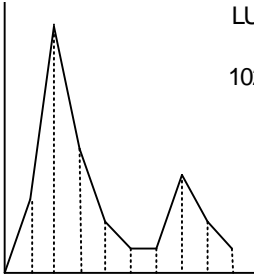
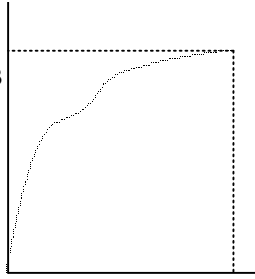
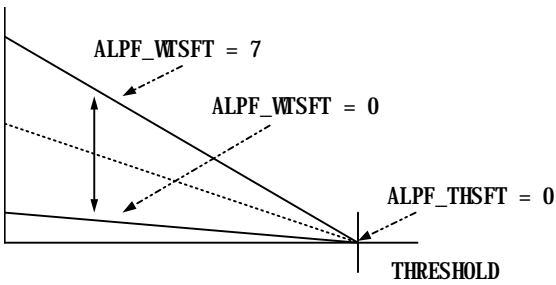
Table 6. Micom Input(Continued)

Register Bits	MICOM Command	Default Value
[207:200]	HLOG4 [7:0]	?
	<div style="border: 1px solid black; padding: 5px; text-align: center;">HLOG4 [7:0]</div> - Log scaling and accumulation value for histogram of luminance level 33 ~ 45	
[199:192]	HLOG5 [7:0]	?
	<div style="border: 1px solid black; padding: 5px; text-align: center;">HLOG5 [7:0]</div> - Log scaling and accumulation value for histogram of luminance	
[191:184]	HLOG6 [7:0]	?
	<div style="border: 1px solid black; padding: 5px; text-align: center;">HLOG5 [7:0]</div> - Log scaling and accumulation value for histogram of luminance	
[183:176]	HLOG7 [7:0]	?
	<div style="border: 1px solid black; padding: 5px; text-align: center;">HLOG7 [7:0]</div> - Log scaling and accumulation value for histogram of luminance	
[175:168]	HLOG8 [7:0]	?
	<div style="border: 1px solid black; padding: 5px; text-align: center;">HLOG8 [7:0]</div> - Log scaling and accumulation value for histogram of luminance	
[167:160]	HLOG9 [7:0]	?
	<div style="border: 1px solid black; padding: 5px; text-align: center;">HLOG9 [7:0]</div> - Log scaling and accumulation value for histogram of luminance level 182 ~ 255	
[159:128]	RESERVED [31:0]	0 0 0 0 _ 0 0 0 0
	<div style="border: 1px solid black; padding: 5px; text-align: center;">RESERVED [31:0]</div> - Reserved	
[127:120]	AESUMH_W1 [7:0]	?
	<div style="border: 1px solid black; padding: 5px; text-align: center;">AESUMH_W1 [7:0]</div> - Refer to KS7331's DCP ODM block	

Table 6. Micom Input(Continued)

Register Bits	MICOM Command	Default Value
	Function	
[119:112]	AESUMM_W1 [7:0]	?
	<div style="border: 1px solid black; width: 100%; height: 20px; margin: 0 auto;"></div> AESUMH_W1 [7:0]	
	- Refer to KS7331's DCP ODM block	
[111:104]	AESUML_W1 [7:0]	?
	<div style="border: 1px solid black; width: 100%; height: 20px; margin: 0 auto;"></div> AESUML_W1 [7:0]	
	- Refer to KS7331's DCP ODM block	
[103:96]	AESUMH_W2 [7:0]	?
	<div style="border: 1px solid black; width: 100%; height: 20px; margin: 0 auto;"></div> AESUMH_W2 [7:0]	
	- Refer to KS7331's DCP ODM block	
[95:88]	AESUMM_W2 [7:0]	0 0 0 0 _ 0 0 0 0
	<div style="border: 1px solid black; width: 100%; height: 20px; margin: 0 auto;"></div> AESUMM_W2 [7:0]	
	- Refer to KS7331's DCP ODM block	
[87:80]	AESUML_W2 [7:0]	?
	<div style="border: 1px solid black; width: 100%; height: 20px; margin: 0 auto;"></div> AESUML_W2 [7:0]	
	- Refer to KS7331's DCP ODM block	
[79:72]	AECLIPH [7:0]	?
	<div style="border: 1px solid black; width: 100%; height: 20px; margin: 0 auto;"></div> AECLIPH [7:0]	
	- Refer to KS7331's DCP ODM block	
[71:64]	AECLIPL [7:0]	?
	<div style="border: 1px solid black; width: 100%; height: 20px; margin: 0 auto;"></div> AECLIPL [7:0]	
	- Refer to KS7331's DCP ODM block	
[63:0]	RESERVED [63:0]	0 0 0 0 _ 0 0 0 0
	<div style="border: 1px solid black; width: 100%; height: 20px; margin: 0 auto;"></div> RESERVED [63:0]	
	- Reserved	

APPLICATION CIRCUIT

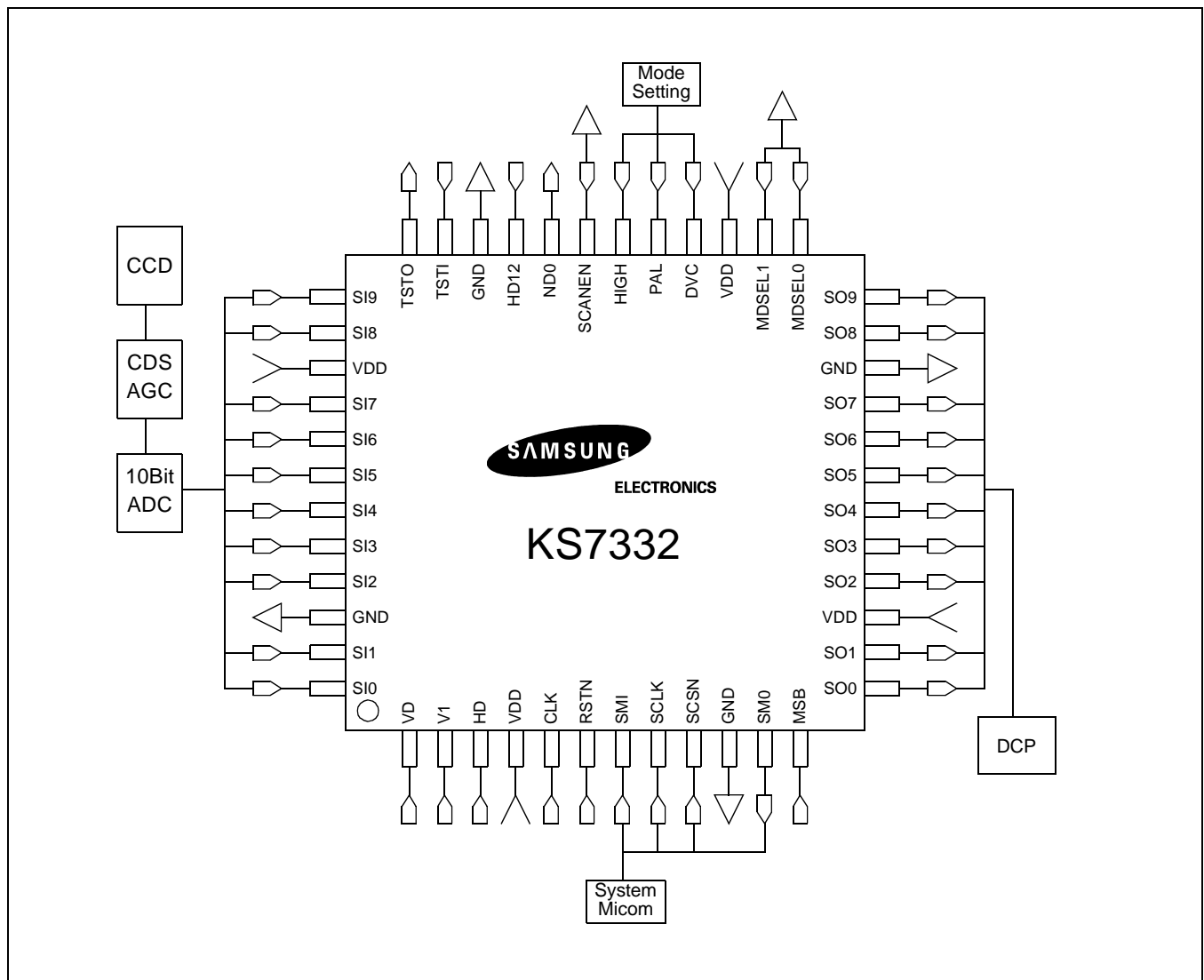

Figure 5. Application Circuit