

## Infrared Emitting Diode, 950 nm, GaAs

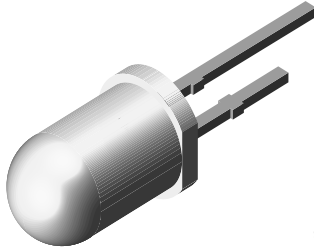

94 8390

### DESCRIPTION

TSUS5400 is an infrared, 950 nm emitting diode in GaAs technology molded in a blue-gray tinted plastic package.

### FEATURES

- Package type: leaded
- Package form: T-1 $\frac{3}{4}$
- Dimensions (in mm):  $\varnothing$  5
- Leads with stand-off
- Peak wavelength:  $\lambda_p = 950$  nm
- High reliability
- Angle of half intensity:  $\varphi = \pm 22^\circ$
- Low forward voltage
- Suitable for high pulse current operation
- Good spectral matching with Si photodetectors
- Compliant to RoHS directive 2002/95/EC and in accordance to WEEE 2002/96/EC
- Halogen-free according to IEC 61249-2-21 definition



**RoHS**  
COMPLIANT  
HALOGEN  
**FREE**

### APPLICATIONS

- Infrared remote control and free air transmission systems with low forward voltage and small package requirements
- Emitter in transmissive sensors
- Emitter in reflective sensors

### PRODUCT SUMMARY

COMPONENT	$I_e$ (mW/sr)	$\varphi$ (deg)	$\lambda_p$ (nm)	$t_r$ (ns)
TSUS5400	14	$\pm 22$	950	800
TSUS5401	17	$\pm 22$	950	800
TSUS5402	20	$\pm 22$	950	800

#### Note

Test conditions see table "Basic Characteristics"

### ORDERING INFORMATION

ORDERING CODE	PACKAGING	REMARKS	PACKAGE FORM
TSUS5400	Bulk	MOQ: 4000 pcs, 4000 pcs/bulk	T-1 $\frac{3}{4}$
TSUS5401	Bulk	MOQ: 4000 pcs, 4000 pcs/bulk	T-1 $\frac{3}{4}$
TSUS5402	Bulk	MOQ: 4000 pcs, 4000 pcs/bulk	T-1 $\frac{3}{4}$

#### Note

MOQ: minimum order quantity

### ABSOLUTE MAXIMUM RATINGS

PARAMETER	TEST CONDITION	SYMBOL	VALUE	UNIT
Reverse voltage		$V_R$	5	V
Forward current		$I_F$	150	mA
Peak forward current	$t_p/T = 0.5, t_p = 100 \mu s$	$I_{FM}$	300	mA
Surge forward current	$t_p = 100 \mu s$	$I_{FSM}$	2.5	A
Power dissipation		$P_V$	170	mW
Junction temperature		$T_j$	100	$^\circ C$
Operating temperature range		$T_{amb}$	- 40 to + 85	$^\circ C$
Storage temperature range		$T_{stg}$	- 40 to + 100	$^\circ C$
Soldering temperature	$t \leq 5$ s, 2 mm from case	$T_{sd}$	260	$^\circ C$
Thermal resistance junction/ambient	J-STD-051, leads 7 mm, soldered on PCB	$R_{thJA}$	230	K/W

#### Note

$T_{amb} = 25 \text{ }^\circ C$ , unless otherwise specified

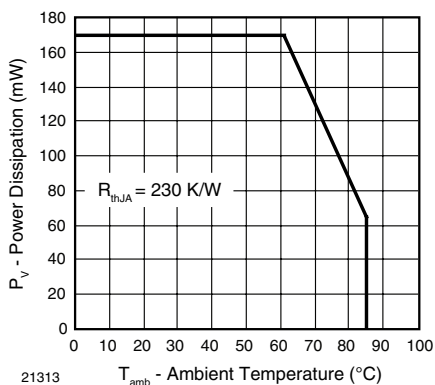

Fig. 1 - Power Dissipation Limit vs. Ambient Temperature

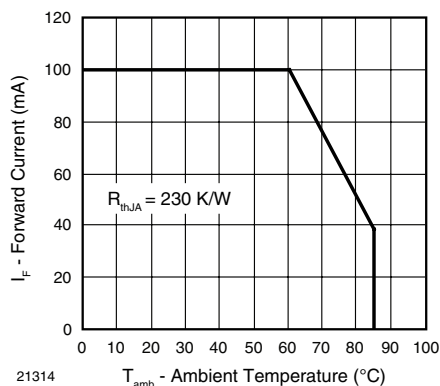

Fig. 2 - Forward Current Limit vs. Ambient Temperature

BASIC CHARACTERISTICS						
PARAMETER	TEST CONDITION	SYMBOL	MIN.	TYP.	MAX.	UNIT
Forward voltage	I <sub>F</sub> = 100 mA, t <sub>p</sub> = 20 ms	V <sub>F</sub>		1.3	1.7	V
Temperature coefficient of V <sub>F</sub>	I <sub>F</sub> = 100 mA	TK <sub>V<sub>F</sub></sub>		- 1.3		mV/K
Reverse current	V <sub>R</sub> = 5 V	I <sub>R</sub>			100	μA
Junction capacitance	V <sub>R</sub> = 0 V, f = 1 MHz, E = 0	C <sub>j</sub>		30		pF
Temperature coefficient of φ <sub>e</sub>	I <sub>F</sub> = 20 mA	TKφ <sub>e</sub>		- 0.8		%/K
Angle of half intensity		φ		± 22		deg
Peak wavelength	I <sub>F</sub> = 100 mA	λ <sub>p</sub>		950		nm
Spectral bandwidth	I <sub>F</sub> = 100 mA	Δλ		50		nm
Temperature coefficient of λ <sub>p</sub>	I <sub>F</sub> = 100 mA	TKλ <sub>p</sub>		0.2		nm/K
Rise time	I <sub>F</sub> = 100 mA	t <sub>r</sub>		800		ns
	I <sub>F</sub> = 1.5 A	t <sub>r</sub>		400		ns
Fall time	I <sub>F</sub> = 100 mA	t <sub>f</sub>		800		ns
	I <sub>F</sub> = 1.5 A	t <sub>f</sub>		400		ns
Virtual source diameter		d		2.9		mm

**Note**

T<sub>amb</sub> = 25 °C, unless otherwise specified

TYPE DEDICATED CHARACTERISTICS							
PARAMETER	TEST CONDITION	PART	SYMBOL	MIN.	TYP.	MAX.	UNIT
Forward voltage	I <sub>F</sub> = 1.5 A, t <sub>p</sub> = 100 μs	TSUS5400	V <sub>F</sub>		2.2	3.4	V
		TSUS5401	V <sub>F</sub>		2.2	3.4	V
		TSUS5402	V <sub>F</sub>		2.2	2.7	V
Radiant intensity	I <sub>F</sub> = 100 mA, t <sub>p</sub> = 20 ms	TSUS5400	I <sub>e</sub>	7	14	35	mW/sr
		TSUS5401	I <sub>e</sub>	10	17	35	mW/sr
		TSUS5402	I <sub>e</sub>	15	20	35	mW/sr
	I <sub>F</sub> = 1.5 A, t <sub>p</sub> = 100 μs	TSUS5400	I <sub>e</sub>	60	140		mW/sr
		TSUS5401	I <sub>e</sub>	85	160		mW/sr
		TSUS5402	I <sub>e</sub>	120	190		mW/sr
Radiant power	I <sub>F</sub> = 100 mA, t <sub>p</sub> = 20 ms	TSUS5400	φ <sub>e</sub>		13		mW
		TSUS5401	φ <sub>e</sub>		14		mW
		TSUS5402	φ <sub>e</sub>		15		mW

**Note**

T<sub>amb</sub> = 25 °C, unless otherwise specified



# TSUS5400, TSUS5401, TSUS5402

Infrared Emitting Diode, 950 nm, GaAs Vishay Semiconductors

## BASIC CHARACTERISTICS

$T_{amb} = 25\text{ }^{\circ}\text{C}$ , unless otherwise specified

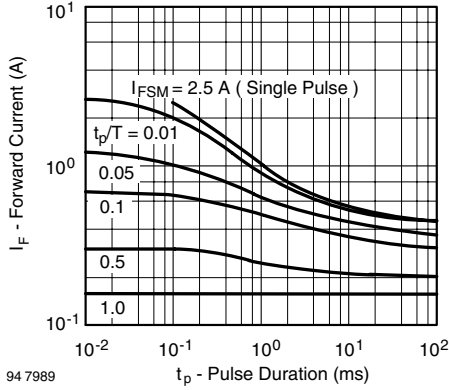

Fig. 3 - Pulse Forward Current vs. Pulse Duration

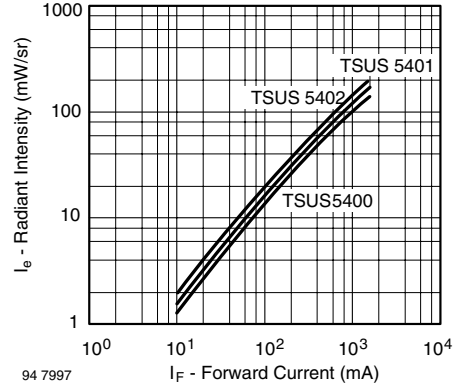

Fig. 6 - Radiant Intensity vs. Forward Current

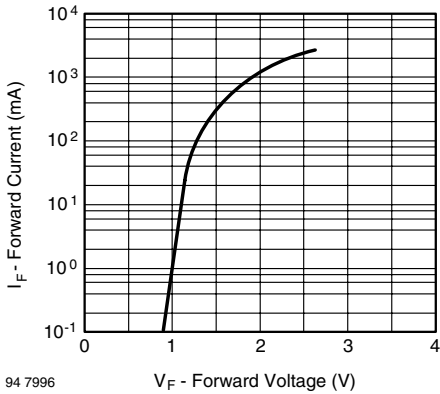

Fig. 4 - Forward Current vs. Forward Voltage

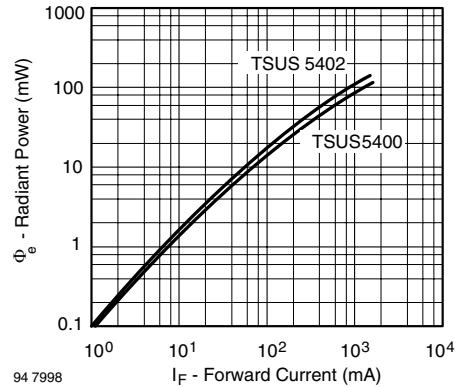

Fig. 7 - Radiant Power vs. Forward Current

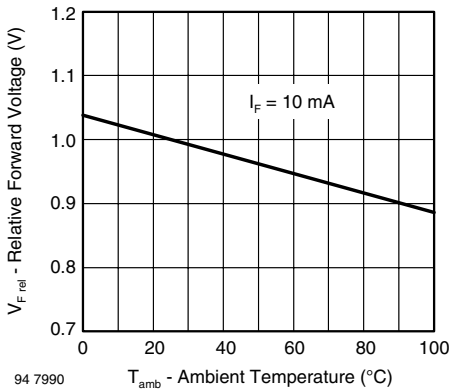

Fig. 5 - Relative Forward Voltage vs. Ambient Temperature

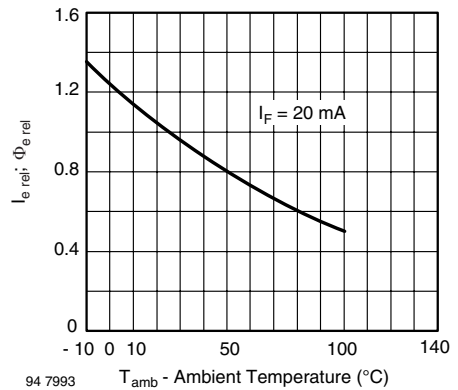

Fig. 8 - Relative Radiant Intensity/Power vs. Ambient Temperature

# TSUS5400, TSUS5401, TSUS5402



Vishay Semiconductors Infrared Emitting Diode, 950 nm, GaAs

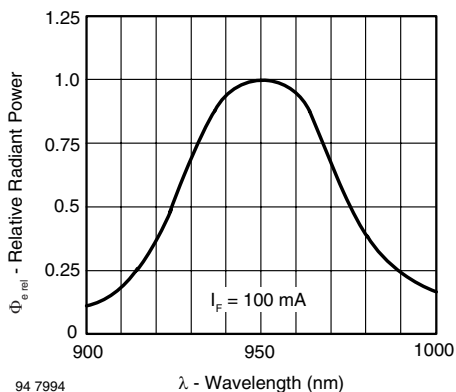

Fig. 9 - Relative Radiant Power vs. Wavelength

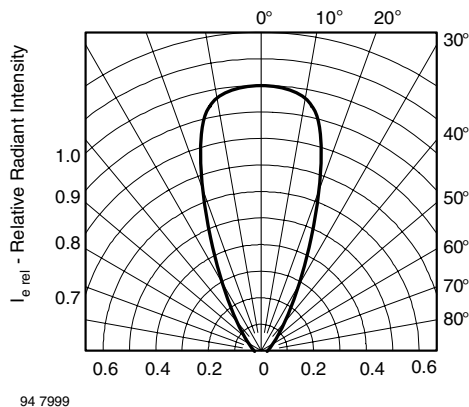
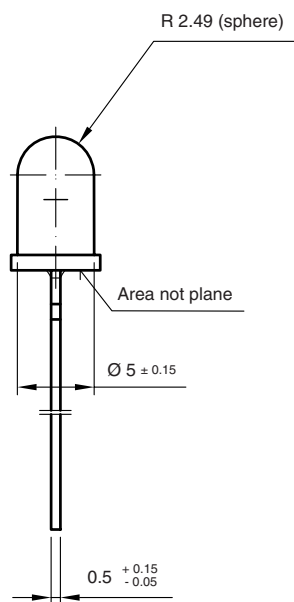
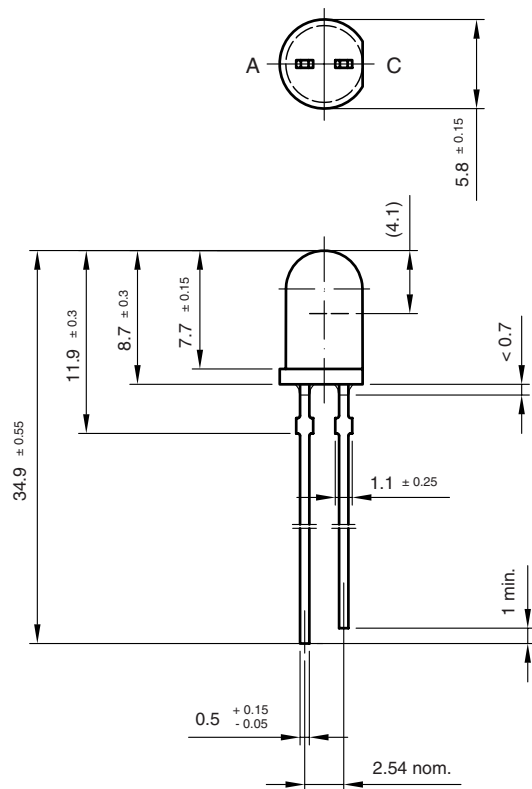

Fig. 10 - Relative Radiant Intensity vs. Angular Displacement

## PACKAGE DIMENSIONS in millimeters



technical drawings according to DIN specifications

6.544-5258.01-4  
Issue: 5; 19.05.09  
96 12119



## Disclaimer

ALL PRODUCT, PRODUCT SPECIFICATIONS AND DATA ARE SUBJECT TO CHANGE WITHOUT NOTICE TO IMPROVE RELIABILITY, FUNCTION OR DESIGN OR OTHERWISE.

Vishay Intertechnology, Inc., its affiliates, agents, and employees, and all persons acting on its or their behalf (collectively, "Vishay"), disclaim any and all liability for any errors, inaccuracies or incompleteness contained in any datasheet or in any other disclosure relating to any product.

Vishay makes no warranty, representation or guarantee regarding the suitability of the products for any particular purpose or the continuing production of any product. To the maximum extent permitted by applicable law, Vishay disclaims (i) any and all liability arising out of the application or use of any product, (ii) any and all liability, including without limitation special, consequential or incidental damages, and (iii) any and all implied warranties, including warranties of fitness for particular purpose, non-infringement and merchantability.

Statements regarding the suitability of products for certain types of applications are based on Vishay's knowledge of typical requirements that are often placed on Vishay products in generic applications. Such statements are not binding statements about the suitability of products for a particular application. It is the customer's responsibility to validate that a particular product with the properties described in the product specification is suitable for use in a particular application. Parameters provided in datasheets and/or specifications may vary in different applications and performance may vary over time. All operating parameters, including typical parameters, must be validated for each customer application by the customer's technical experts. Product specifications do not expand or otherwise modify Vishay's terms and conditions of purchase, including but not limited to the warranty expressed therein.

Except as expressly indicated in writing, Vishay products are not designed for use in medical, life-saving, or life-sustaining applications or for any other application in which the failure of the Vishay product could result in personal injury or death. Customers using or selling Vishay products not expressly indicated for use in such applications do so at their own risk and agree to fully indemnify and hold Vishay and its distributors harmless from and against any and all claims, liabilities, expenses and damages arising or resulting in connection with such use or sale, including attorneys fees, even if such claim alleges that Vishay or its distributor was negligent regarding the design or manufacture of the part. Please contact authorized Vishay personnel to obtain written terms and conditions regarding products designed for such applications.

No license, express or implied, by estoppel or otherwise, to any intellectual property rights is granted by this document or by any conduct of Vishay. Product names and markings noted herein may be trademarks of their respective owners.