

Silicon PNP Power Transistors

2SB1154

DESCRIPTION

- With TO-3PFa package
- Complement to type 2SD1705
- Low collector saturation voltage
- Satisfactory linearity of h_{FE}

APPLICATIONS

- For power switching applications

PINNING

PIN	DESCRIPTION
1	Base
2	Collector
3	Emitter

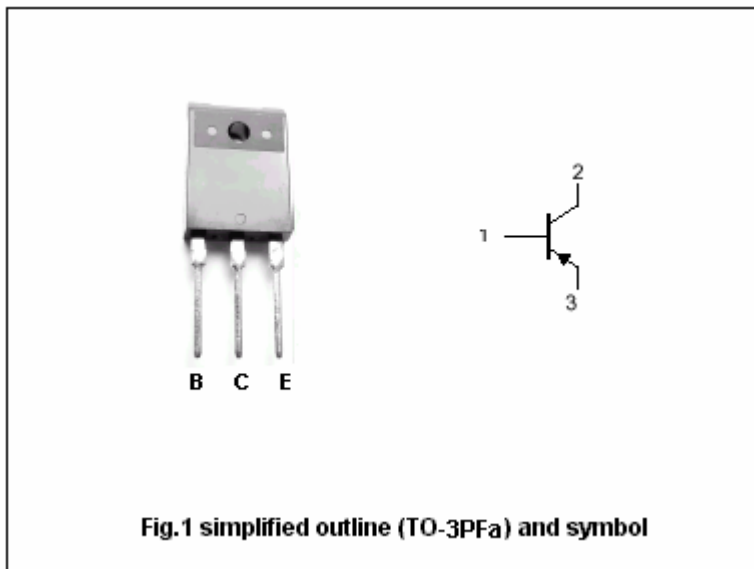

Absolute maximum ratings($T_a=25^\circ C$)

SYMBOL	PARAMETER	CONDITIONS	VALUE	UNIT
V_{CBO}	Collector-base voltage	Open emitter	-130	V
V_{CEO}	Collector-emitter voltage	Open base	-80	V
V_{EBO}	Emitter-base voltage	Open collector	-7	V
I_C	Collector current		-10	A
I_{CM}	Collector current-peak		-20	A
P_C	Collector power dissipation	$T_C=25^\circ C$	70	W
		$T_a=25^\circ C$	3	
T_j	Junction temperature		150	$^\circ C$
T_{stg}	Storage temperature		-55~150	$^\circ C$

Silicon PNP Power Transistors

2SB1154

CHARACTERISTICS

T_j=25 °C unless otherwise specified

SYMBOL	PARAMETER	CONDITIONS	MIN	TYP.	MAX	UNIT
V _{(BR)CEO}	Collector-emitter breakdown voltage	I _C =-10mA ; I _B =0	-80			V
V _{CEsat-1}	Collector-emitter saturation voltage	I _C =-6A ; I _B =-0.3A			-0.5	V
V _{CEsat-2}	Collector-emitter saturation voltage	I _C =-10A ; I _B =-1A			-1.5	V
V _{BEsat-1}	Base-emitter saturation voltage	I _C =-6A ; I _B =-0.3A			-1.5	V
V _{BEsat-2}	Base-emitter saturation voltage	I _C =-10A ; I _B =-1A			-2.5	V
I _{CBO}	Collector cut-off current	V _{CB} =-100V ; I _E =0			-10	μA
I _{EBO}	Emitter cut-off current	V _{EB} =-5V ; I _C =0			-50	μA
h _{FE-1}	DC current gain	I _C =-0.1A ; V _{CE} =-2V	45			
h _{FE-2}	DC current gain	I _C =-3A ; V _{CE} =-2V	90		260	
h _{FE-3}	DC current gain	I _C =-6A ; V _{CE} =-2V	30			
f _T	Transition frequency	I _C =-0.5A ; V _{CE} =-10V ; f=10MHz		30		MHz

Switching times

t _{on}	Turn-on time	I _C =-6A ; I _{B1} =-I _{B2} =-0.6A V _{CC} =-50V		0.5		μs
t _{stg}	Storage time			1.0		μs
t _f	Fall time			0.2		μs

◆ h_{FE-2} classifications

Q	P
90-180	130-260

Silicon PNP Power Transistors

2SB1154

PACKAGE OUTLINE

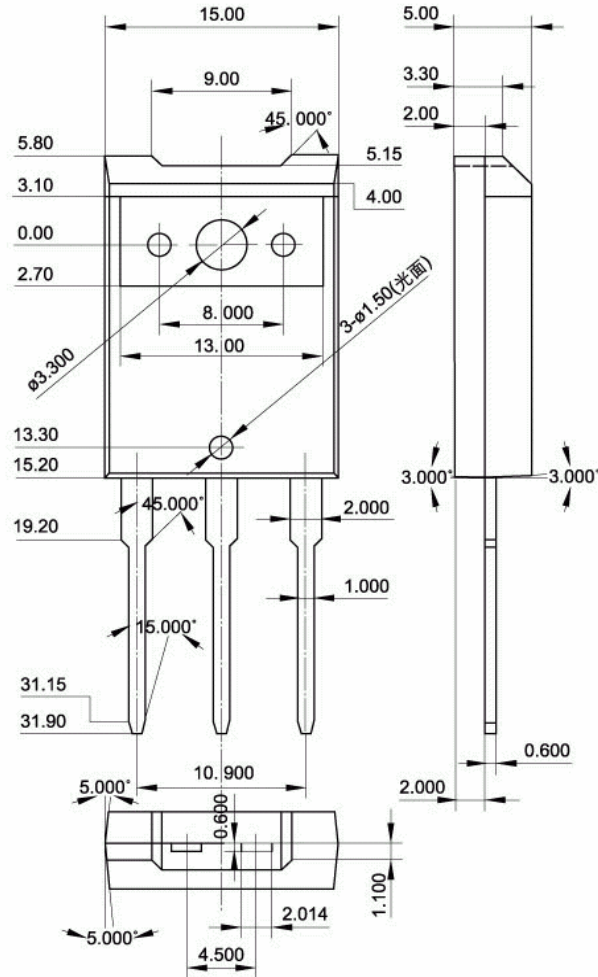

Fig.2 Outline dimensions (unindicated tolerance:±0.30mm)

Silicon PNP Power Transistors

2SB1154

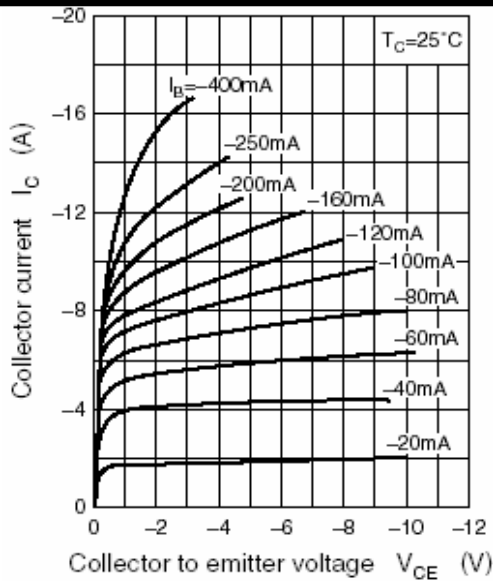

Fig.3 Static Characteristic

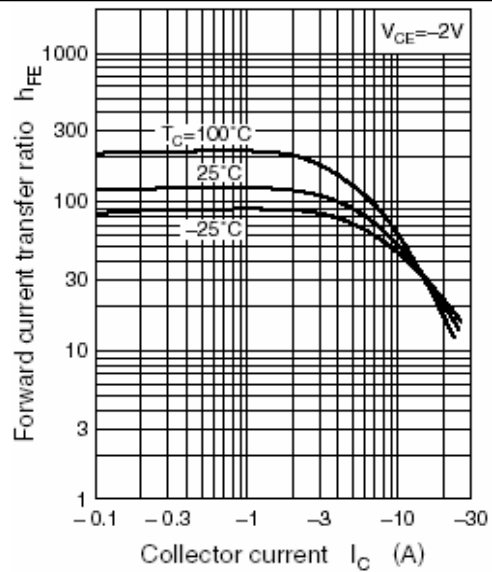

Fig.4 DC current Gain

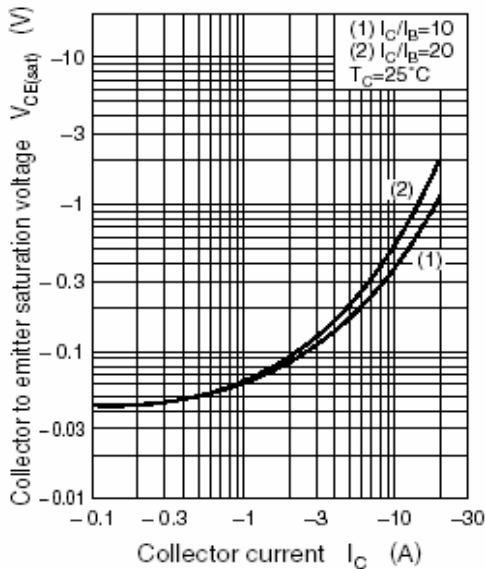

Fig.5 Collector-Emitter Saturation Voltage

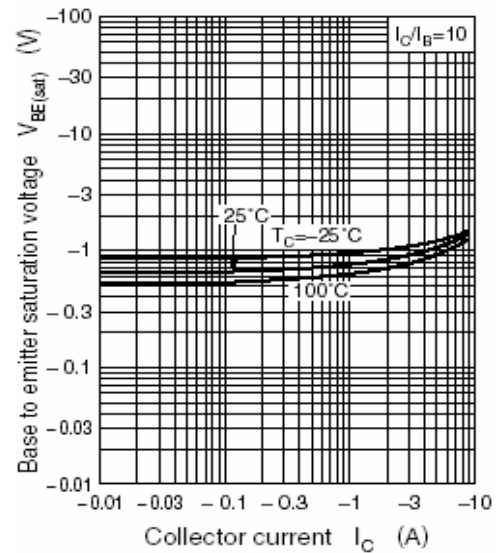

Fig.6 Base-Emitter Saturation Voltage

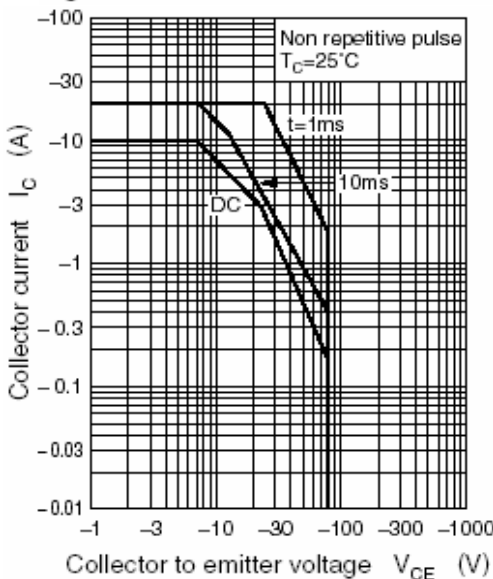

Fig.7 Safe Operating Area