

## 5-4000 MHz Cascadeable InGaP HBT Gain Block

### Device Features

- 33 dBm Output IP3 at 5dBm/tone
- 24.9 dB Gain at 900 MHz
- 18 dBm P1dB
- Highly Reliable InGaP/GaAs HBT Technology
- 50 ohm Cascadeable
- Application: commercial wireless system

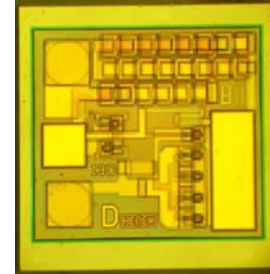

### Target Device Performance ( $T_a = 25^\circ\text{C}$ )

Symbols	Test Conditions	Min	Typ	Max	Unit
<b>Frequency Range</b>		5		4000	MHz
<b>Gain</b>	900 MHz	23.9	24.9	25.9	dB
	1900 MHz	22.0	23.0	24.0	
	2450 MHz	20.6	21.6	22.6	
<b>S11</b>	900 MHz		-11.7		dB
	1900 MHz		-10.4		
	2450 MHz		-11.9		
<b>S22</b>	900 MHz		-7.6		dB
	1900 MHz		-13.4		
	2450 MHz		-12.0		
<b>OIP3</b>	900 MHz	31.0	33.0		dBm
	1900 MHz	30.7	32.7		
	2450 MHz	29.5	31.5		
<b>P1dB</b>	900 MHz	17.3	18.3		dBm
	1900 MHz	17.2	18.2		
	2450 MHz	16.4	17.4		
<b>Ic</b>	Vc = 5.0V	59	69	79	mA
<b>Vc</b>			5.0		V
<b>dG/dT</b>			-0.007		dB/°C
<b>Rth</b>	Thermal Resistance		85		°C/W

Test conditions unless otherwise noted.

1. Device performance is measured on BeRex evaluation board at 25C, 50 ohm system
2. OIP3 measured with two tones at an output power of 5 dBm/tone separated by 1 MHz.

### Absolute Maximum Ratings

Parameter	Rating
Operating Case temperature	-40 to +85°C
Storage Temperature	-40 to +155°C
Operating Voltage	+5.5V
Supply Current	150 mA
Input RF Power	23dBm

Operation of this device above any of these parameters may result in permanent damage.

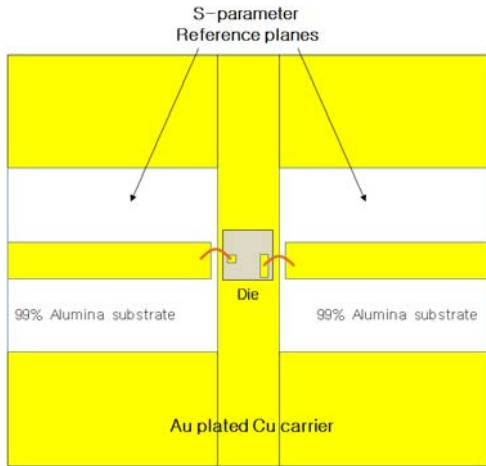

S-parameter test circuit

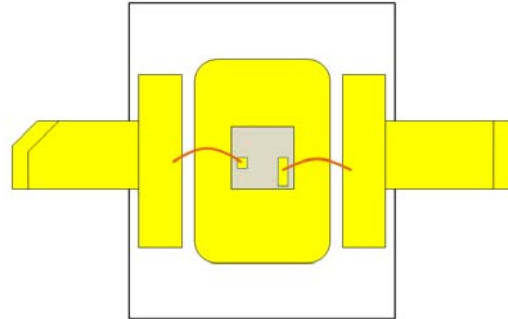

Chip attachment on PF083

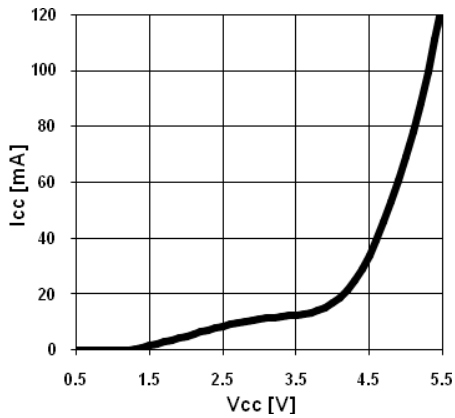

I-V characteristics

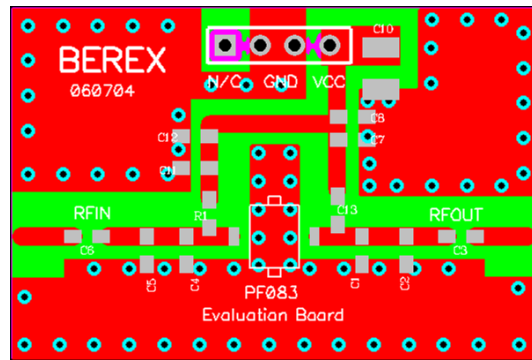

Generic PF083 Evaluation Board (31mil thick FR4)

### Application Circuit: 5-4000 MHz

Typical Performance ( $V_c = 5V$ ,  $I_c = 69mA$ ,  $T = 25^\circ C$ )

Freq	MHz	900	1900	2450
S21	dB	24.9	23.0	22.5
S11	dB	-11.7	-10.4	-11.9
S22	dB	-7.6	-13.4	-12.0
P1	dBm	19.0	19.0	19.0
OIP3	dBm	32.0	32.0	31.0

Schematic Diagram	BOM		Tolerance
	C1	100pF	±5%
	C2	100pF	±5%
	C3	100pF	±5%
	C4	1000pF	±5%
	C5	10uF	±20%
	L1*	39nH	5%

\*Note:

1. Chip is mounted on the PF083 open PKG, and bonded with 2-wires at both input and output.
2. Less than 20nH improves RF performance at frequencies over 1.9GHz.
3. 40nH or higher value L1 improves RF performance at frequencies under 500MHz.
4. Optimum value of L1 may vary with board design.

### Typical Device Data

S-parameters (Vc=5V, Ic=65mA, T=25°C)

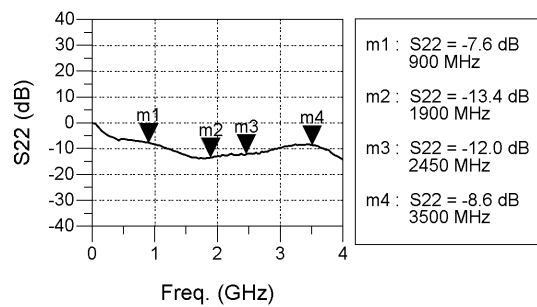
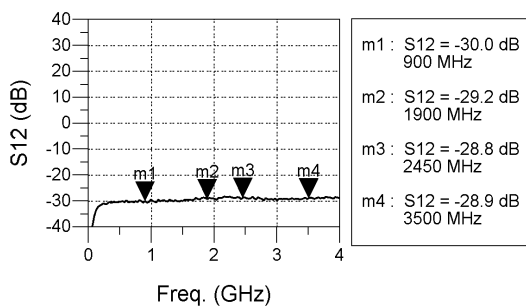
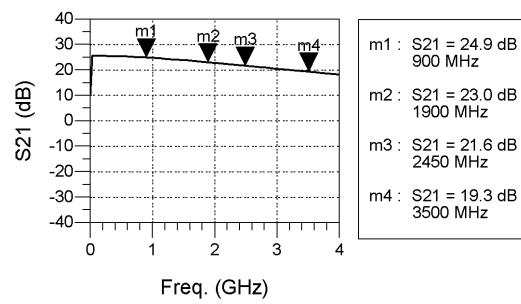
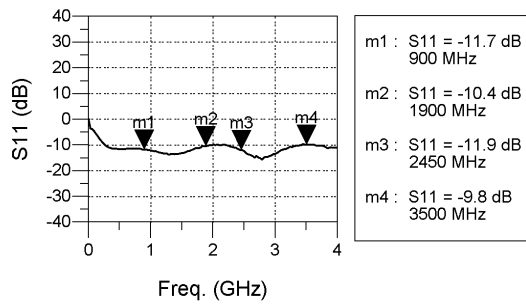

## Device Performance

### P1dB-Gain

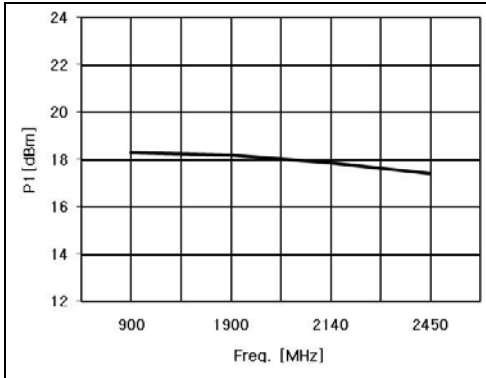

P1

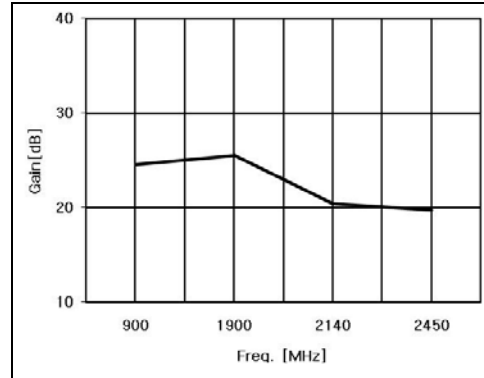

Gain

### OIP3

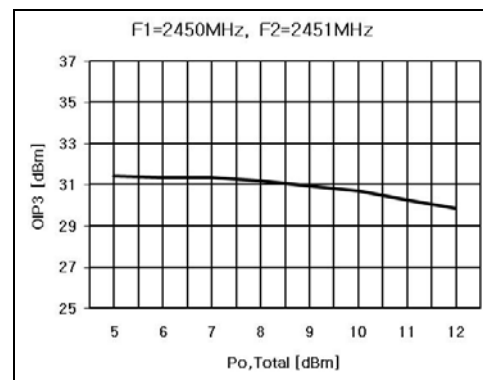
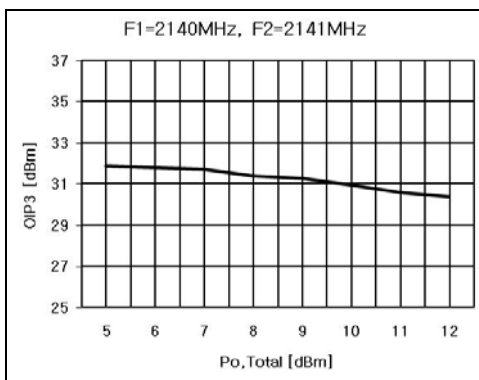
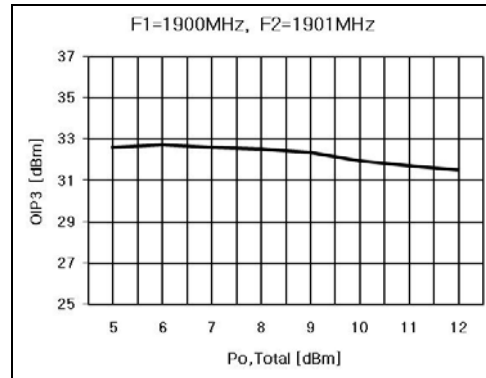
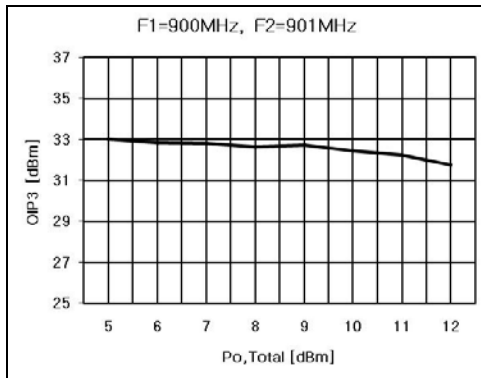

ACPR

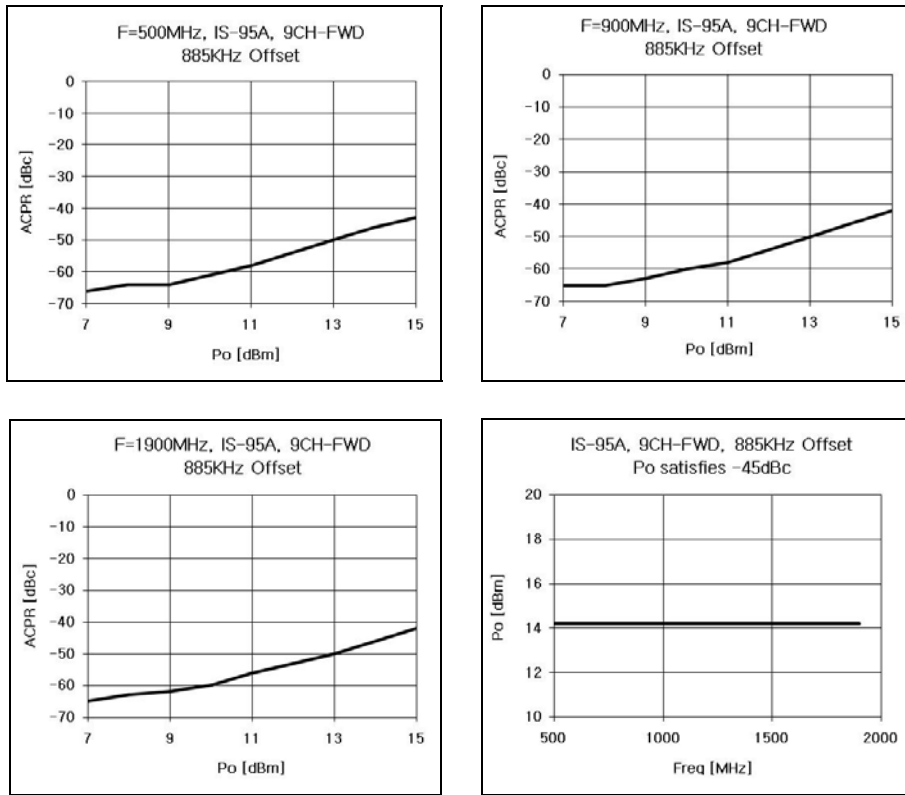

S-Parameter

(Vdevice = 5.0V, Icc = 69mA, T = 25 °C, calibrated to device leads)

Freq [MHz]	S11 [dB]	S11 [Ang]	S21 [dB]	S21 [Ang]	S12 [dB]	S12 [Ang]	S22 [dB]	S22 [Ang]
100	-4.678	-25.54	25.672	176.84	-35.909	77.16	-1.418	173.59
500	-11.610	-16.90	25.427	159.35	-30.250	-25.07	-6.267	29.56
1000	-12.057	-12.98	24.828	141.93	-29.445	50.31	-8.236	-7.08
1500	-13.053	16.38	23.968	124.40	-30.025	-114.05	-12.494	-26.17
2000	-9.849	17.27	22.767	109.52	-29.185	-159.59	-12.806	-17.49
2500	-12.146	-27.86	21.639	96.24	-28.649	158.92	-11.873	-64.24
3000	-13.490	-123.12	20.413	84.08	-29.741	116.90	-9.756	-130.88
3500	-9.805	-167.89	19.346	73.06	-28.948	77.73	-8.579	-170.03
4000	-11.035	-160.29	18.256	63.61	-24.947	32.85	-14.089	-165.34

\* Note : S-parameter includes 1 mil thick and 16-mil long Au wire

## Die Outline

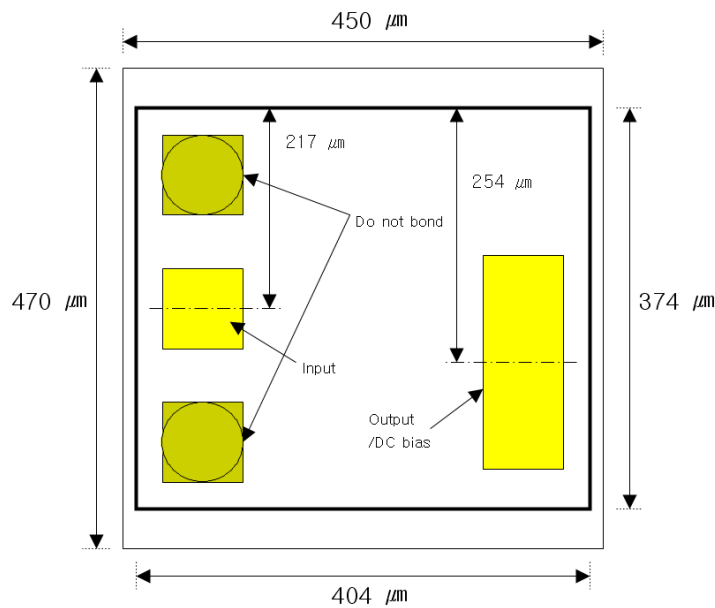

### NOTES:

- 1) DIE THICKNESS 100 $\mu\text{m}$
- 2) BONDPAD METAL THICKNESS 2.8 $\mu\text{m}$
- 3) BACKSIDE METAL Au, 5 $\mu\text{m}$
- 4) DEVICE IS GROUNDED THROUGH VIA HOLES

## ESD Rating

<b>ESD Rating:</b>	Class 1C
<b>Value:</b>	Passes <2000V
<b>Test:</b>	Human Body Model (HBM)
<b>Standard:</b>	JEDEC Standard JESD22-A114B

## NATO CAGE code:

2	N	9	6	F
---	---	---	---	---

### NOTICE

BeRex Corporation reserves the right to make changes of product specification or to discontinue product at any time without notice.



Proper ESD procedures should be followed when handling this device.