



Typical Applications

The HMC630LP3(E) is ideal for:

- Wireless Infrastructure HPA & MPCA Error Correction
- Pre-Distortion or Feed-Forward Linearization
- Cellular / 3G Systems
- Beam Forming or RF Cancellation Circuits

Features

- Continuous Phase Control: 360°
- Continuous Gain Control: 40 dB
- Low Output Noise Floor: -162 dBm/Hz
- High Input IP3: +34 dBm
- 16 Lead 3x3mm SMT Package: 9mm²

Functional Diagram

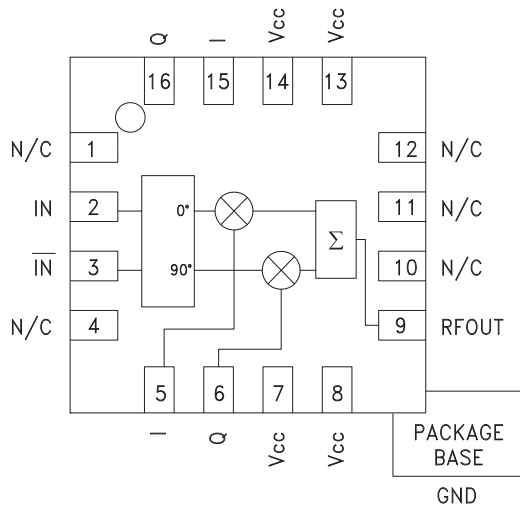

General Description

The HMC630LP3 & HMC630LP3E are high dynamic range Vector Modulator RFICs which are targeted for RF predistortion and feed-forward cancellation circuits, as well as RF beam forming and amplitude/phase correction circuits. The I & Q ports of the HMC630LP3(E) can be used to continuously vary the phase and amplitude of RF signals by up to 360 degrees and 40 dB respectively, while supporting a 3 dB modulation bandwidth of 180 MHz. With an output IP3 of +24.5 dBm and output noise floor of -162 dBm/Hz (at maximum gain setting), the output IP3/ noise floor ratio is 186.5 dB.

Electrical Specifications, $T_A = +25^\circ C$, $V_{cc} = +8V$

Parameter	Min.	Typ.	Max.	Units
Frequency Range		0.7 - 1.0		GHz
Maximum Gain ^[1]	-12	-10		dB
Gain Variation Over Temperature		0.02	0.03	dB / °C
Gain Flatness Across Any 60 MHz Bandwidth		0.10		dB
Gain Range		40		dB
Input Return Loss		15		dB
Output Return Loss		17		dB
Input Power for 1dB Compression (P1dB)	14	17		dBm
Input Third Order Intercept (IP3)		34		dBm
Output Noise		-162		dBm/Hz
Control Port Bandwidth (-3 dB)		180		MHz
Control Port Impedance		1.45k		Ohms
Control Port Capacitance		0.22		pF
Control Voltage Range		+0.5 to +2.5		Vdc
Group Delay Variation Over 60 MHz Bandwidth		20		ps
Supply Current (Icq)		92		mA

Unless otherwise noted, measurements are made @ max. gain setting and 45° phase setting.

See application circuit for details.

^[1]Includes loss of input balun (0.75 dB typ.).

For price, delivery, and to place orders, please contact Hittite Microwave Corporation:
 20 Alpha Road, Chelmsford, MA 01824 Phone: 978-250-3343 Fax: 978-250-3373
 Order On-line at www.hittite.com



HMC630LP3 / 630LP3E

GaAs HBT VECTOR MODULATOR 700 - 1000 MHz

Maximum Gain vs. Temperature

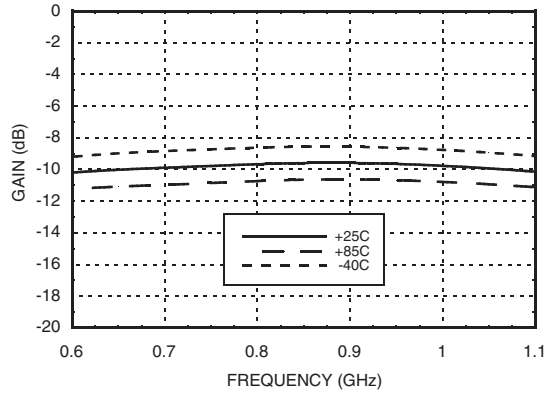

Maximum Gain vs. Supply Voltage

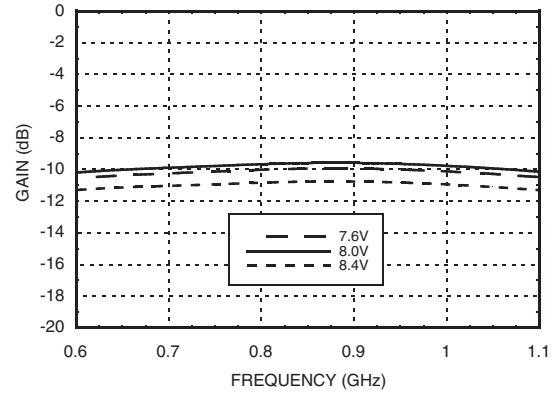

Gain vs. Phase Settings @ F= 900 MHz

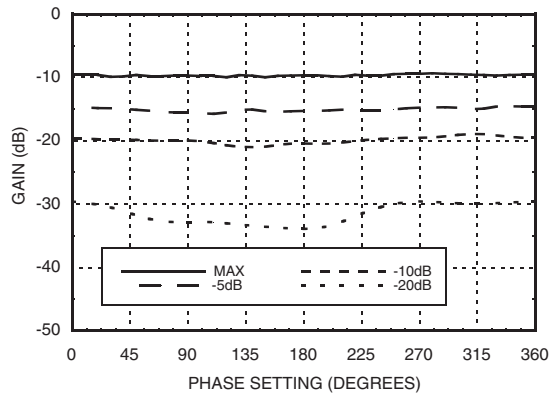

**Phase vs. Phase Settings @ F= 900 MHz
vs. Various Gain Settings**

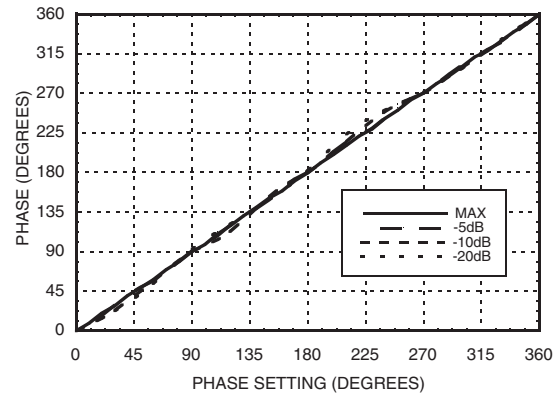

Input Return Loss vs. Temperature

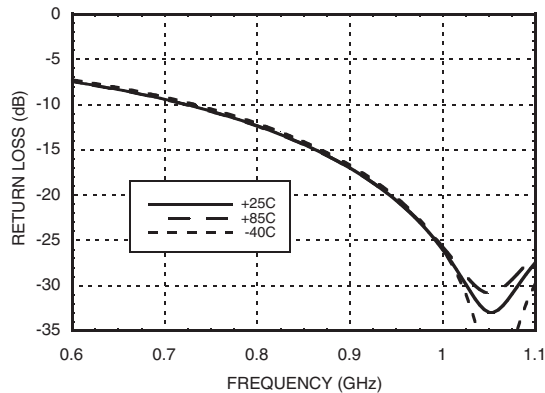

Output Return Loss vs. Temperature

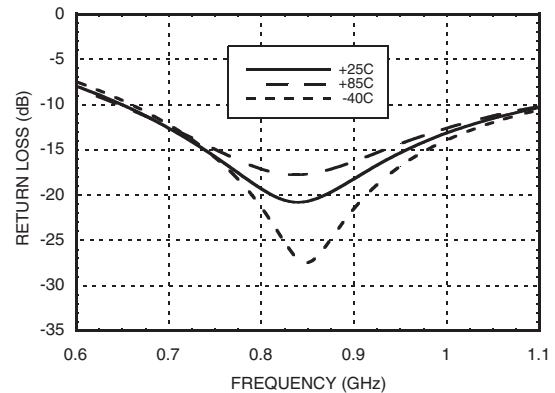



HMC630LP3 / 630LP3E

GaAs HBT VECTOR MODULATOR 700 - 1000 MHz

10

MODULATORS - SMT

Output Noise vs. Temperature

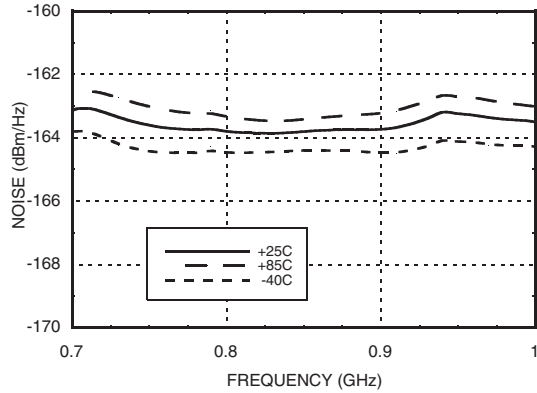

Output Noise vs. Phase Settings @ F= 900 MHz

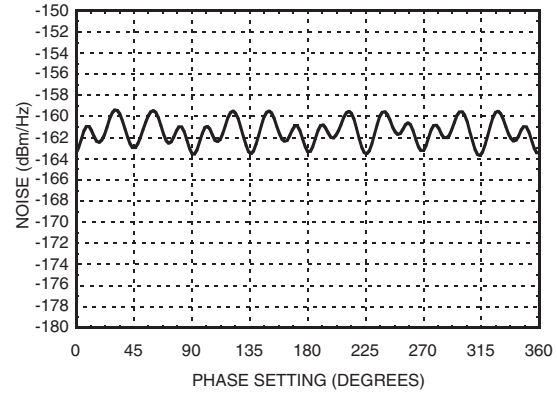

Input P1dB vs. Temperature

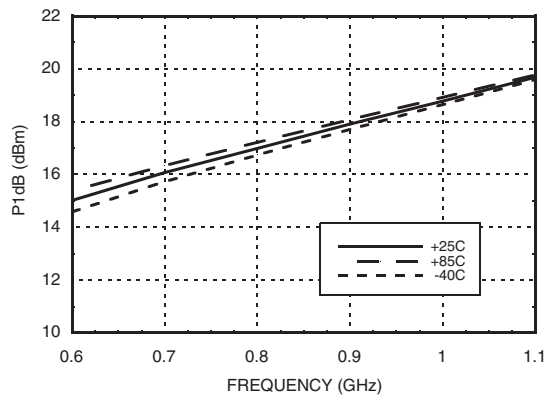

Input IP3 vs. Temperature

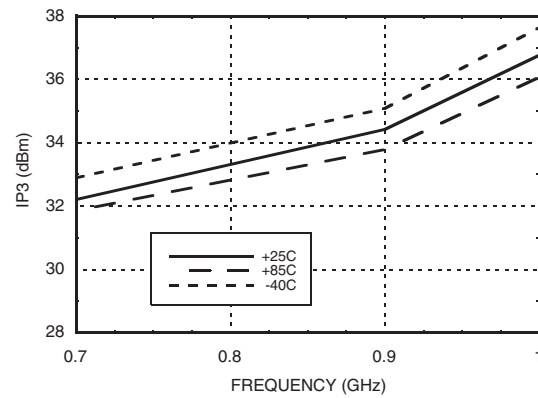

Group Delay

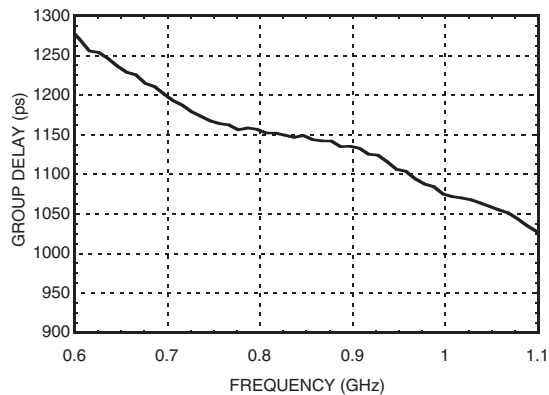

Linear Gain vs. Phase Setting

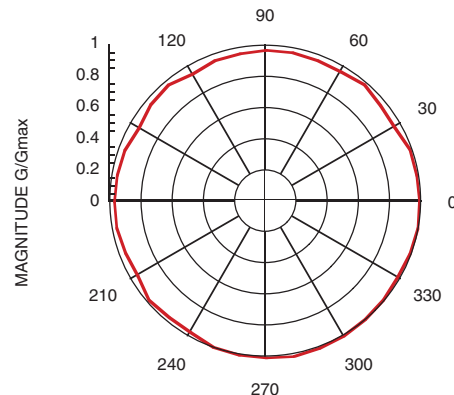



HMC630LP3 / 630LP3E

GaAs HBT VECTOR MODULATOR 700 - 1000 MHz

Typical Supply Current vs. Vcc

Vcc (V)	Icc (mA)
7.6	86
8.0	92
8.4	98

Note:
Modulator will operate over full voltage range shown above.



**ELECTROSTATIC SENSITIVE DEVICE
OBSERVE HANDLING PRECAUTIONS**

Absolute Maximum Ratings

RF Input (Vcc = +8V)	27 dBm
Supply Voltage (Vcc)	+10V
I & Q Input	-0.5V to +5.0V
Junction Temperature (Tc)	135 °C
Continuous P _{diss} (T = 85°C) (Derate 34 mW/°C above 85°C)	1.7 W
Thermal Resistance (R _{th}) (junction to ground paddle)	29.6 °C/W
Storage Temperature	-65 to +150 °C
Operating Temperature	-40 to +85 °C

Outline Drawing

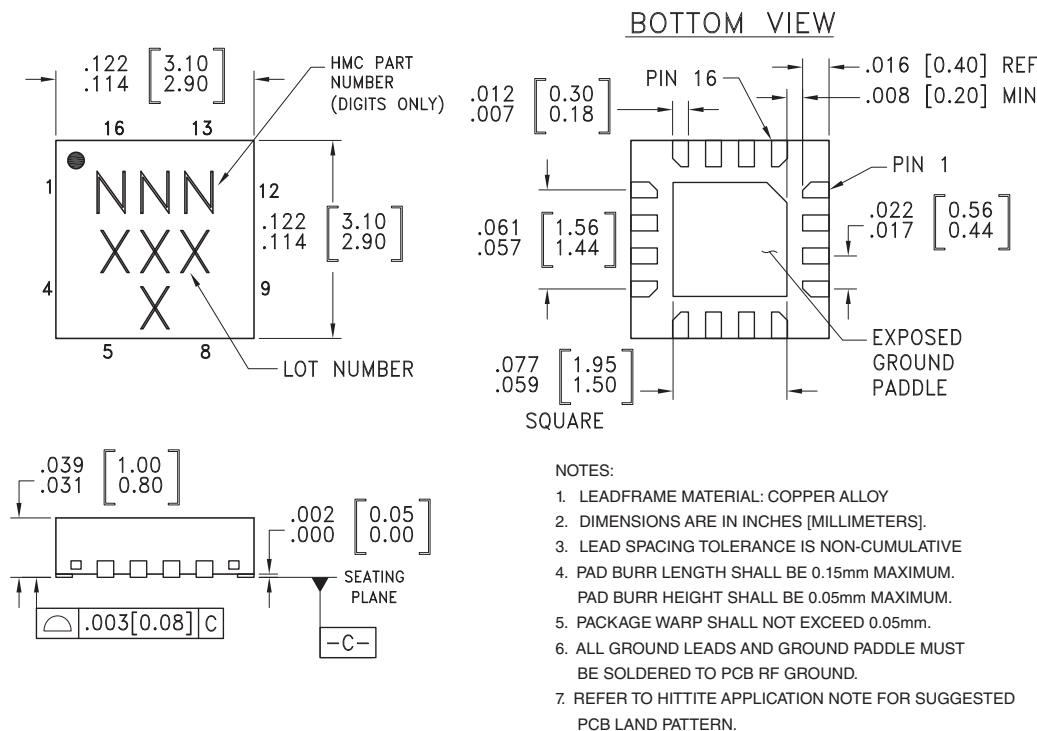

Package Information

Part Number	Package Body Material	Lead Finish	MSL Rating	Package Marking ^[3]
HMC630LP3	Low Stress Injection Molded Plastic	Sn/Pb Solder	MSL1 ^[1]	630 XXXX
HMC630LP3E	RoHS-compliant Low Stress Injection Molded Plastic	100% matte Sn	MSL1 ^[2]	630 XXXX

[1] Max peak reflow temperature of 235 °C



[2] Max peak reflow temperature of 260 °C

[3] 4-Digit lot number XXXX

For price, delivery, and to place orders, please contact Hittite Microwave Corporation:
20 Alpha Road, Chelmsford, MA 01824 Phone: 978-250-3343 Fax: 978-250-3373
Order On-line at www.hittite.com

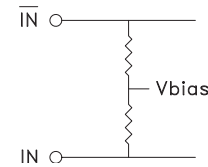
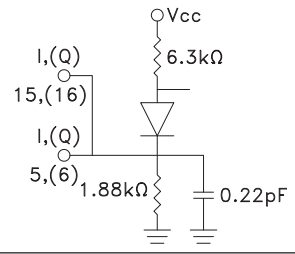
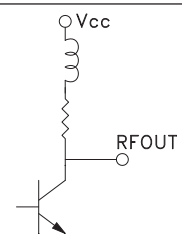

Pin Description

Pin Number	Function	Description	Interface Schematic
1, 4, 10 - 12	N/C	No connection. These pins may be connected to RF ground. Performance will not be affected	
2, 3	IN, \bar{IN}	Differential RF inputs, 100 Ohms differential impedance. (i.e. each pin is 50 Ohms to ground). Must be DC blocked.	
5, 15	I	In-phase control input. Pins 5 and 15 are redundant. Either input can be used.	
6, 16	Q	Quadrature control input. Pins 6 and 16 are redundant. Either input can be used.	
7, 8, 13, 14	Vcc	Supply Voltage, pins are DC connected on-chip. It is only necessary to supply Vcc to any 1 of the 4 pins, but all 4 pins must be bypassed to ground. (See application circuit).	
9	RFOUT	RF Output: Must be DC blocked.	
	GND	Ground: Backside of package has exposed metal ground paddle which must be connected to RF/DC ground.	

Application Circuit

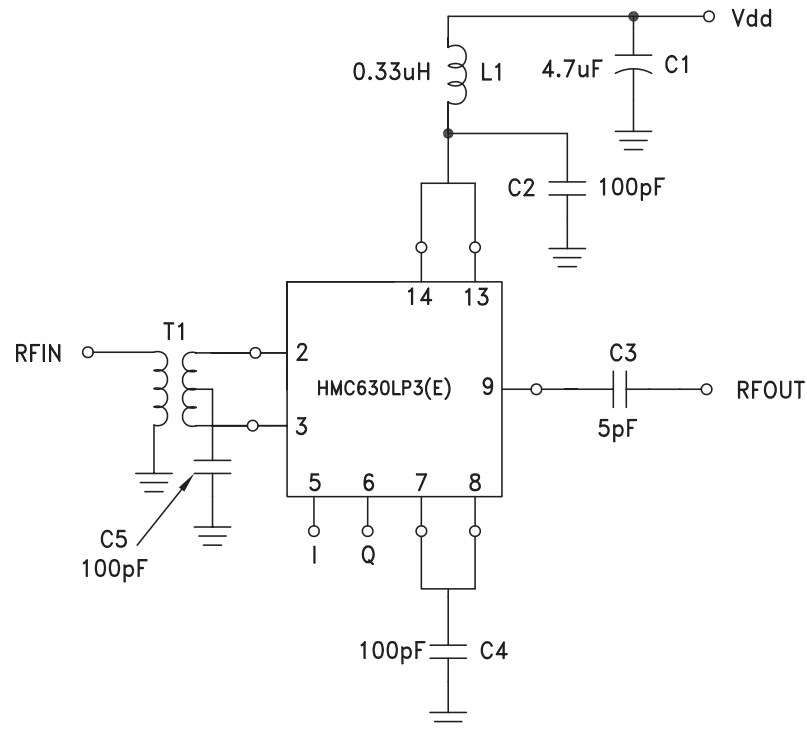

* Pins 15 & 16 are redundant I & Q inputs.

Gain and Phase control are applied through the I and Q control ports. For a given linear gain (G) and phase (θ) setting, the voltages applied to these ports in all measurements are calculated as follows:

$$I(G, \theta) = V_{mi} + 1.0V \frac{G}{G_{max}} \cos(\theta)$$

$$Q(G, \theta) = V_{mq} + 1.0V \frac{G}{G_{max}} \sin(\theta)$$

Where V_{mi} and V_{mq} are the I and Q voltage settings corresponding to maximum isolation at room temperature and $F = 0.9$ GHz. Note that $G = 10^x$ and $G_{max} = 10^y$ where $x = \frac{\text{Gain Setting (dB)}}{20}$ and $y = \frac{\text{Max Gain Setting (dB)}}{20}$. Nominally $V_{mi} = V_{mq} = 1.5V$, $G_{max} = 0.316$.

Evaluation PCB

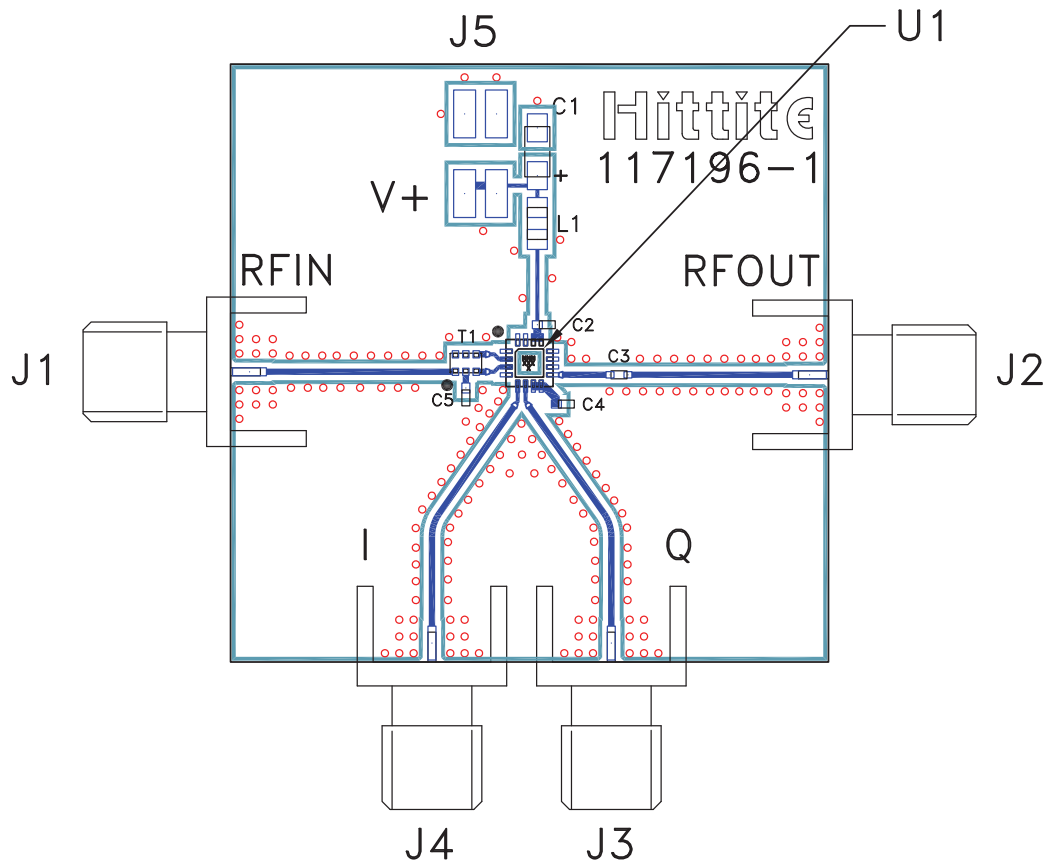

List of Materials for Evaluation PCB 117198 [1]

Item	Description
J1 - J4	PCB Mount SMA Connector
J5	2 mm DC Header
C1	4.7 μ F Capacitor, Tantalum
C2, C4, C5	100 pF Capacitor, 0402 Pkg.
C3 [3]	5 pF Capacitor, 0402 pkg
T1	Balun, 0805 Pkg. ANAREN BD0810J50100A
L1	330 nH Inductor, 0805 Pkg.
U1	HMC630LP3(E) Vector Modulator
PCB [2]	117196 Evaluation PCB

[1] Reference this number when ordering complete evaluation PCB

[2] Circuit Board Material: Rogers 4350, Er = 3.48

[3] Locate close to HMC630LP3E package

The circuit board used in the final application should use RF circuit design techniques. Signal lines should have 50 ohm impedance while the package ground leads and exposed paddle should be connected directly to the ground plane similar to that shown. A sufficient number of via holes should be used to connect the top and bottom ground planes. The evaluation board should be mounted to an appropriate heat sink. The evaluation circuit board shown is available from Hittite upon request.



Notes: