

# Dual Output BWR Models

## High-Density, 2" x 2" 15-20 Watt, DC/DC Converters

### Features

- $\pm 5$ ,  $\pm 9$ ,  $\pm 12$  or  $\pm 15$  Volt outputs
- Choice of 3 ultra-wide input ranges:  
4.6-13.2 Volts  
9-36 Volts  
18-72 Volts
- Industry-standard pinouts
- Modern SMT-on-ceramic construction
- Guaranteed efficiencies to 82%
- Internal input/output filtering
- Low ripple/noise, excellent line/load regulation
- Fully isolated (750Vdc min.) and I/O protected
- External  $V_{OUT}$  trim, remote on/off control
- $-25$  to  $+100^{\circ}\text{C}$  operation, shielded cases
- EMI/EMC characterization data available
- UL 1950, CSA 22.2 No. 234 and IEC 950
- Modifications and customs for OEM's

For your mid-range power requirements, it's hard to beat the combination of features and benefits offered by DATEL's BWR Model, dual-output, 15-20 Watt, DC/DC converters. Their ultra-wide input voltage ranges (4.6-13.2V for "D5" models, 9-36V for "D12" models or 18-72V for "D48" models) are ideal for battery-operated systems or for distributed power systems with poorly regulated intermediate bus voltages. Their  $\pm 5$ ,  $\pm 9$ ,  $\pm 12$  or  $\pm 15$  Volt outputs cover virtually all popular applications.

These units are packaged in standard, 2" x 2" x 0.45", shielded metal cases with standard pinouts; however, they deliver more output power than virtually all competing devices. Their impressive power densities (to 11.2W/in<sup>3</sup>) are achieved by combining highly efficient (to 82% minimum), switching (165kHz), current-mode circuit topologies with DATEL's integrated approach to thermal management (including low-profile SMT-on-ceramic construction and a new thermally-conductive potting compound).

These popular converters are fully isolated (750Vdc minimum), fully regulated (with specifications as low as  $\pm 0.3\%$  max. for line and  $\pm 0.5\%$  max. for load regulation), completely I/O protected (input overvoltage shutdown and reverse-polarity protection, output overvoltage protection and current limiting), and contain internal input (pi type) and output filters. They require no external components and offer true "plug-and-play" convenience.

BWR Model dual-output DC/DC's offer a remote on/off control pin and  $V_{OUT}$  trim capabilities for critical applications. They are easy-to-use, cost-effective, extremely reliable power converters that can greatly simplify your next design effort.

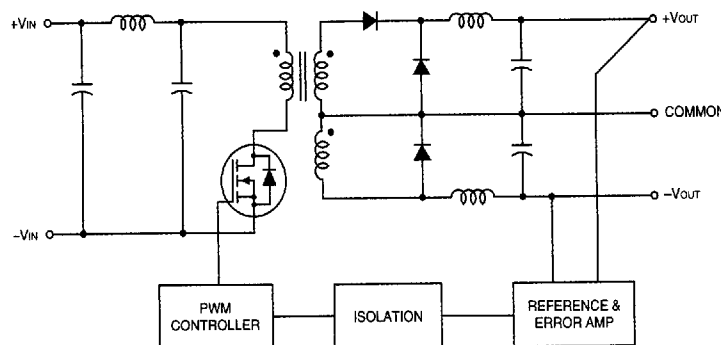

Figure 1. Simplified Schematic

### Performance Specifications and Ordering Guide ①

Model	Output					Input			Efficiency (Min.)	Package (Case, Pinout)
	V <sub>out</sub> (Volts)	I <sub>out</sub> (mA, Max.)	Ripple/Noise ② (mVp-p, Max.)	Regulation (Max.)		V <sub>in</sub> Nom. (Volts)	Range (Volts)	I <sub>in</sub> ③ (mA, Max.)		
				Line	Load ③					
BWR-5/1500-D5	±5	±1500	75	±0.3%	±0.5%	5	4.6-13.2	90/3880	78%	C4, P7
BWR-5/1700-D12	±5	±1700	100	±0.3%	±0.5%	24	9-36	40/893	81%	C4, P7
BWR-5/1700-D48	±5	±1700	100	±0.4%	±0.5%	48	18-72	25/442	81%	C4, P7
BWR-9/850-D5	±9	±850	150	±0.3%	±1.0%	5	4.6-13.2	70/4000	78%	C4, P7
BWR-12/625-D5	±12	±625	75	±0.3%	±0.5%	5	4.6-13.2	90/3830	79%	C4, P7
BWR-12/830-D12	±12	±830	100	±0.3%	±0.5%	24	9-36	40/1041	81%	C4, P7
BWR-12/830-D48	±12	±830	100	±0.4%	±0.5%	48	18-72	25/517	81%	C4, P7
BWR-15/500-D5	±15	±500	75	±0.3%	±0.5%	5	4.6-13.2	90/3780	80%	C4, P7
BWR-15/670-D12	±15	±670	100	±0.3%	±0.5%	24	9-36	40/1035	81%	C4, P7
BWR-15/670-D48	±15	±670	100	±0.4%	±0.5%	48	18-72	25/516	82%	C4, P7

- ① Typical at T<sub>A</sub> = +25°C under nominal line voltage and full load conditions unless otherwise noted
- ② 20MHz bandwidth
- ③ Balanced loads, 20% to 100% load.
- ④ Nominal line voltage, no load/full load conditions.

### Part Number Structure

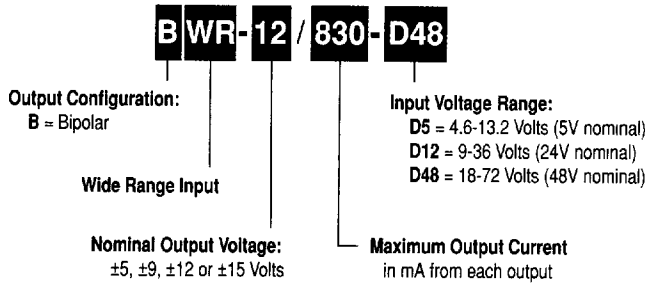

### Temperature Derating

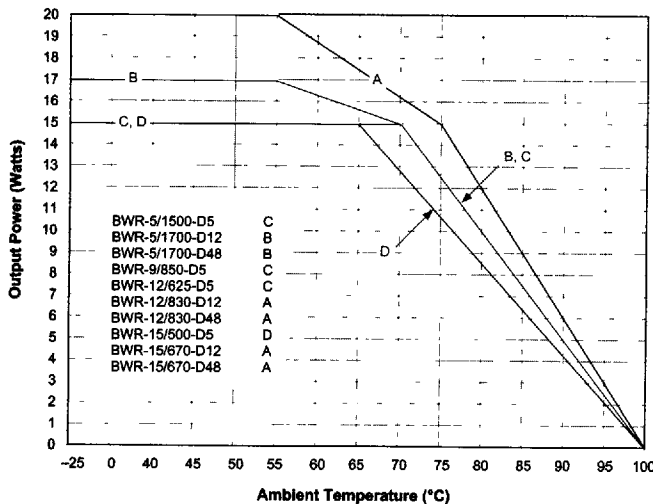

### Mechanical Specifications

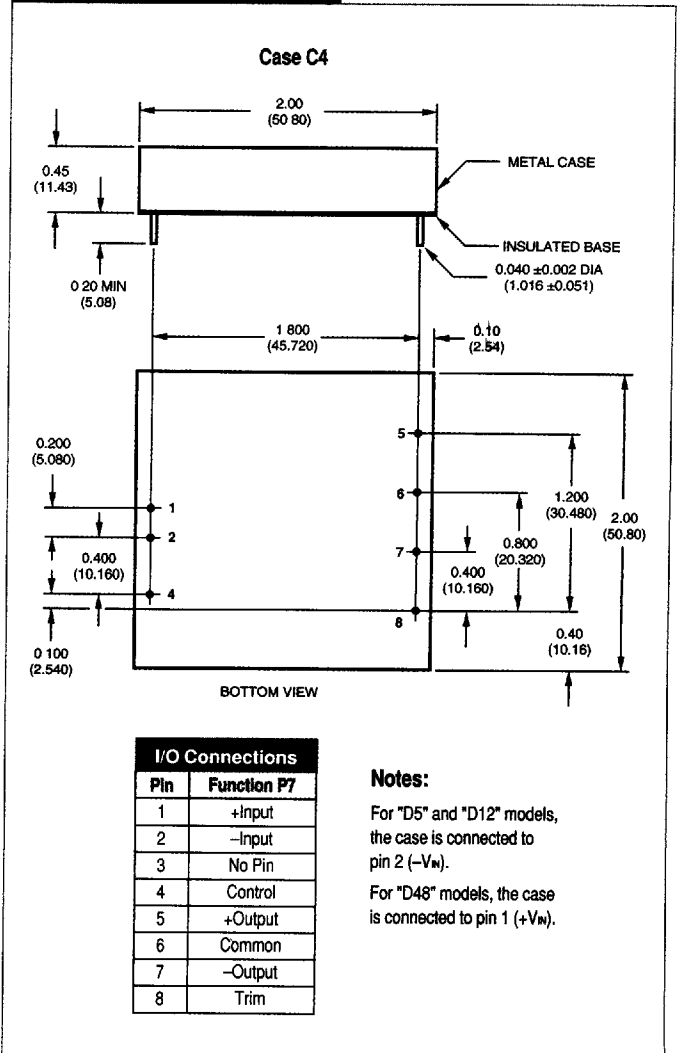

## Performance/Functional Specifications

Typical @  $T_A = +25^\circ\text{C}$  under nominal line voltage and full load conditions unless noted ①

Input	
<b>Input Voltage Range:</b>	
"D5" Models	4.6-13.2 Volts (5V nominal)
"D12" Models	9-36 Volts (24V nominal)
"D48" Models	18-72 Volts (48V nominal)
<b>Input Current</b>	See Ordering Guide
<b>Input Filter Type</b> ②	PI
<b>Overvoltage Shutdown:</b>	
"D5" Models	14 Volts
"D12" Models	40 Volts
"D48" Models	76 Volts
<b>Reverse-Polarity Protection</b>	Yes (Instantaneous, 10A maximum)
<b>On/Off (Sync.) Control (Pin 4)</b> ③	TTL high = off, low (or open) = on
Output	
<b>V<sub>out</sub> Accuracy (50% load):</b>	
±5V Outputs	±1.5%, maximum
±9/12/15V Outputs	±1%, maximum
<b>Temperature Coefficient</b>	±0.02% per °C
<b>Ripple/Noise (20MHz BW)</b> ②	See Ordering Guide
<b>Line/Load Regulation</b>	See Ordering Guide
<b>Efficiency</b>	See Ordering Guide
<b>Isolation Voltage</b> ④	750Vdc, minimum
<b>Isolation Capacitance</b>	550pF
<b>Current Limiting</b>	Auto-recovery
<b>Overvoltage Protection</b>	Clamp, 2W transistor
Dynamic Characteristics	
<b>Transient Response (50% load step)</b>	200µsec max. to ±1.5% of final value
<b>Switching Frequency</b>	165kHz (±15kHz)
Environmental	
<b>Operating Temperature (ambient):</b> ⑤	
Without Derating	-25 to +55/65/70°C (model dependent)
With Derating	to +100°C (See Derating Curves)
<b>Storage Temperature</b>	-55 to +125°C
Physical	
<b>Dimensions</b>	2" x 2" x 0.45" (51 x 51 x 11.4mm)
<b>Shielding</b>	5-sided ⑥
<b>Case Connection:</b>	
"D5" and "D12" Models	Pin 2 (-V <sub>IN</sub> )
"D48" Models	Pin 1 (+V <sub>IN</sub> )
<b>Case Material</b>	Corrosion resistant steel with epoxy-based enamel finish
<b>Pin Material</b>	Brass, solder coated
<b>Weight</b>	2.7 ounces (75.6 grams)

- ① These converters require 20% min. loading to maintain specified regulation. Operation under no-load conditions will not damage these devices, but they may not meet all listed specifications.
- ② Application-specific internal input/output filtering can be added upon request. Contact DATEL.
- ③ Applying a voltage to the Control pin when no input power is applied to the converter can cause permanent damage to the converter.
- ④ Devices can be screened for higher guaranteed isolation voltages. Contact DATEL for details.
- ⑤ Devices can be screened for -40°C operation. Contact DATEL for details.
- ⑥ Cases can be provided with 6-sided shielding. Contact DATEL for details.

## Absolute Maximum Ratings

These are stress ratings. Exposure of devices to any of these conditions may adversely affect long-term reliability. Proper operation under conditions other than those listed in the Performance/Functional Specifications Table is not implied. Storage temperatures have been verified for 168 hours.

<b>Input Voltage:</b>	
"D5" Models	16 Volts
"D12" Models	44 Volts
"D48" Models	80 Volts
<b>Input Reverse-Polarity Protection</b>	Current must be <10A. Brief duration only. Fusing recommended.
<b>Output Overvoltage Protection:</b>	
±5V Outputs	±6.8 Volts, limited duration
±9/12V Outputs	±15 Volts, limited duration
±15V Outputs	±18 Volts, limited duration
<b>Output Current</b>	Current limited. Max. current and short-circuit duration model dependent
<b>Storage Temperature</b>	-55 to +125°C
<b>Lead Temperature (soldering, 10sec.)</b>	+300°C

## Technical Notes

### Floating Outputs

All outputs are floating. Any BWR model may be configured to produce an output of 10V, 24V or 30V (for ±5V, ±12V or ±15V models, respectively) by applying the load across the +Output and -Output pins (pins 5 and 7), with either output grounded. The Common pin (pin 6) should be left open. Minimum 20% loading is recommended under these conditions. The total output voltage span may be externally trimmed as described below.

### Filtering and Noise Reduction

All BWR 15-20 Watt DC/DC Converters achieve their rated ripple and noise specifications without the use of external input/output capacitors. In critical applications, input/output ripple and noise may be further reduced by installing electrolytic capacitors across the input terminals and/or low-ESR tantalum or electrolytic capacitors across the output terminals. Output capacitors should be connected between their respective output pin (pin 5 or 7) and Common (pin 6) as shown in Figure 2. The caps should be located as close to the power converters as possible. Typical values are listed below. In most applications, using values greater than those listed will yield better results.

#### To Reduce Input Ripple

"D5" Models	47µF, 16V
"D12" Models	20µF, 50V
"D48" Models	20µF, 100V

#### To Reduce Output Ripple

±5V Outputs	47µF, 10V, Low ESR
±9/12/15V Outputs	22µF, 20V, Low ESR

In critical, space-sensitive applications, DATEL can easily tailor the internal input/output filtering of these devices to meet your specific requirements. Contact us for additional details.

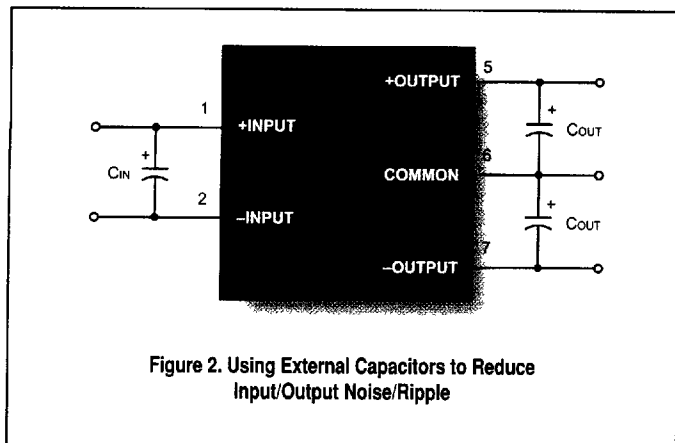

**Figure 2. Using External Capacitors to Reduce Input/Output Noise/Ripple**

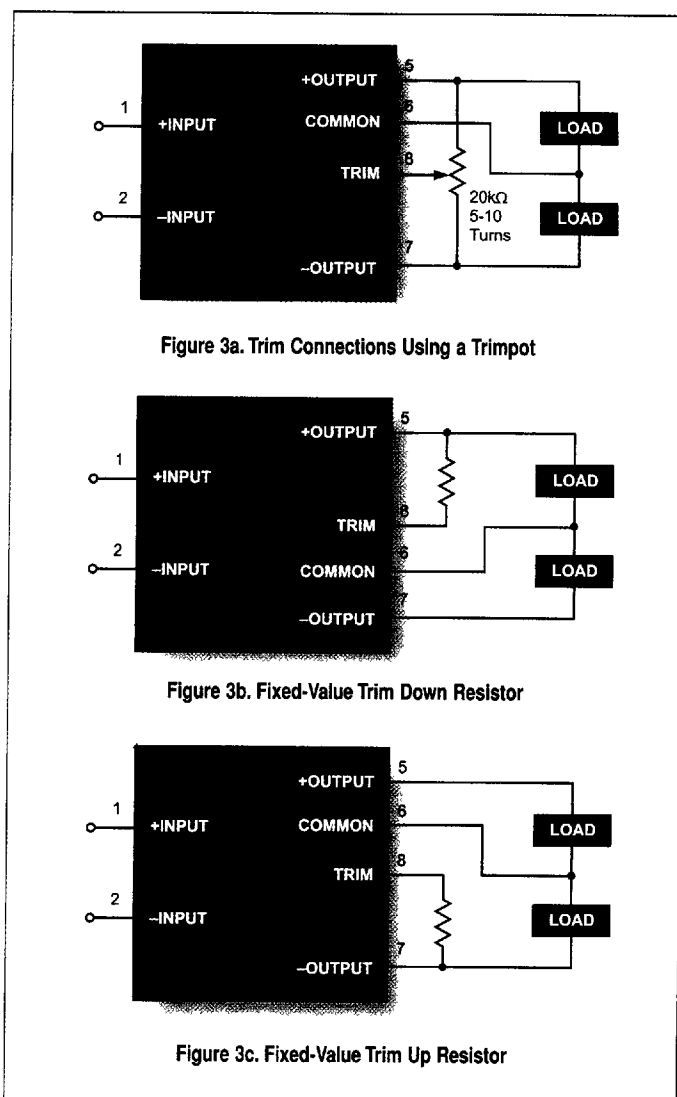

### Input Fusing

Certain applications and/or safety agencies may require the installation of fuses at the inputs of power conversion components. For DATEL BWR 15-20 Watt DC/DC Converters, you should use slow-blow type fuses with values no greater than the following:

V <sub>IN</sub> Range	Fuse Value
"D5"	6A
"D12"	4A
"D48"	2A

### On/Off Control

The On/Off Control pin (pin 4) may be used for remote on/off operation. A TTL logic high (+2 to +5 Volts, 250μA max.) applied to pin 4 disables the converter. A TTL logic low (0 to +0.8 Volts, 70μA max.), or no connection, enables the converter. Control voltages should be referenced to pin 2 (-Input). Applying a voltage to the Control pin when no input power is applied to the converter can cause permanent damage to the converter.

### Synchronization

In certain applications employing multiple BWR converters and also demanding minimal noise levels, some improvements may be had by synchronizing the switching of the various converters. The synchronizing clock should be applied to pin 4 (Control) of each device. It should be a square wave with a maximum 1μsec "high" duration and an amplitude between +2V and +5V (see On/Off Control) referenced to pin 2 (-Input). The frequency of the synchronizing clock should be higher than that of any individual converter. Therefore, it should be 185kHz ±5kHz.

### Output Trimming

The total output voltage span, from +Output (pin 5) to -Output (pin 7) may be trimmed ±5% via a single external trimpot or fixed resistor. The trimpot should be connected as shown in Figure 3a with its wiper connected to pin 8 (Trim). A trimpot can be used to determine the value of a single fixed resistor which should be connected as shown in Figures 3b and 3c. Connect the resistor between pin 8 (Trim) and pin 5 (+Output) to trim "down" the output voltages. Connect the resistor between pins 8 and 7 (-Output) to trim "up" the output voltages. Fixed resistors should be metal-film types with absolute TCR's less than 100ppm/°C to ensure stability.

**Custom Capabilities**

DATEL's world-class design, development and manufacturing team stands ready to work with you to deliver the exact power converter you need for your demanding, large volume, OEM applications. And ... we'll do it on time and within budget!

Our experienced applications and design staffs; quick-turn prototype capability; highly automated, SMT assembly facilities; and in-line SPC quality-control techniques combine to give us the unique ability to design and deliver any quantity of power converters to the highest standards of quality and reliability.

We have compiled a large library of DC/DC designs that are currently used in a variety of telecom, medical, computer, railway, aerospace and industrial applications. We may already have the converter you need.

Contact us. Our goal is to provide you the highest-quality, most cost-effective power converters available.

**EMI Radiated Emissions**

If you're designing with EMC in mind, please note that all of DATEL's BWR 15-20 Watt DC/DC Converters have been characterized for radiated and conducted emissions in our new EMI/EMC laboratory. Testing is conducted in an EMCO 5305 GTEM test cell utilizing EMCO automated EMC test software. Radiated emissions are tested to the limits of FCC Part 15, Class B and CISPR 22 (EN 55022), Class B. Correlation to other specifications can be supplied upon request. Radiated emissions plots to FCC and CISPR 22 for model BWR-12/625-D5 appear below. Published EMC test reports are available for each model number. Contact DATEL's Applications Engineering Department for more details.

**BWR-12/625-D5 Radiated Emissions**

FCC Part 15 Class B, 3 Meters

Converter Output =  $\pm 12Vdc @ \pm 500mA$

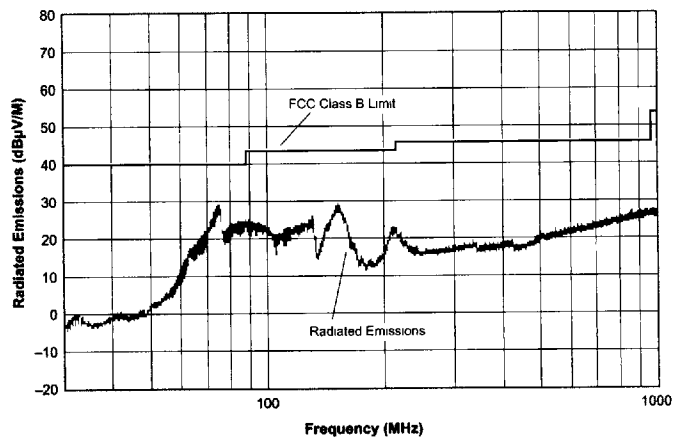

**BWR-12/625-D5 Radiated Emissions**

EN 55022 Class B, 10 Meters

Converter Output =  $\pm 12Vdc @ \pm 500mA$

