

$V_{DRM}$	=	4500 V
$I_{TGQM}$	=	1100 A
$I_{TSM}$	=	$8.8 \times 10^3$ A
$V_{(T0)}$	=	1.65 V
$r_T$	=	1.2 mW
$V_{DC-link}$	=	2800 V

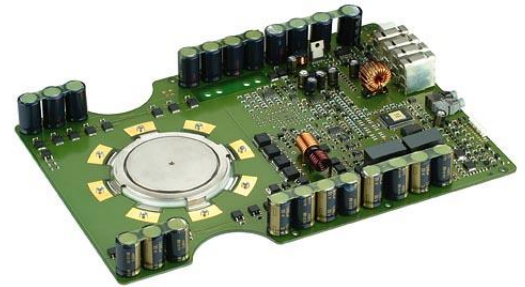
# Reverse Conducting Integrated Gate-Commutated Thyristor

## 5SHX 14H4510

### PRELIMINARY

Doc. No. 5SYA1227-05 Aug 07

- High snubberless turn-off rating
- Optimized for medium frequency (<1 kHz) and low turn-off losses
- High reliability
- High electromagnetic immunity
- Simple control interface with status feedback
- AC or DC supply voltage
- Suitable for series connection (contact factory)



## Blocking

*Maximum rated values* <sup>Note 1</sup>

Parameter	Symbol	Conditions	min	typ	max	Unit
Repetitive peak off-state voltage	$V_{DRM}$	Gate Unit energized			4500	V
Permanent DC voltage for 100 FIT failure rate of RC-GCT	$V_{DC-link}$	Ambient cosmic radiation at sea level in open air. Gate Unit energized			2800	V

*Characteristic values*

Parameter	Symbol	Conditions	min	typ	max	Unit
Repetitive peak off-state current	$I_{DRM}$	$V_D = V_{DRM}$ , Gate Unit energized			20	mA

## Mechanical data

 (see Fig. 20, 21)

*Maximum rated values* <sup>Note 1</sup>

Parameter	Symbol	Conditions	min	typ	max	Unit
Mounting force	$F_m$		18	20	22	kN

*Characteristic values*

Parameter	Symbol	Conditions	min	typ	max	Unit
Pole-piece diameter	$D_p$	$\pm 0.1$ mm		63		mm
Housing thickness	H		25.9		26.4	mm
Weight	m				1.7	kg
Surface creepage distance	$D_s$	Anode to Gate	33			mm
Air strike distance	$D_a$	Anode to Gate	13			mm
Length	l	$\pm 1.0$ mm		296		mm
Height	h	$\pm 1.0$ mm		48		mm
Width IGCT	w	$\pm 1.0$ mm		208		mm

Note 1 Maximum rated values indicate limits beyond which damage to the device may occur

ABB Switzerland Ltd, Semiconductors reserves the right to change specifications without notice.



## GCT Data

### On-state (see Fig. 3 to 6, 23)

#### Maximum rated values <sup>Note 1</sup>

Parameter	Symbol	Conditions	min	typ	max	Unit
Max. average on-state current	$I_{T(AV)M}$	Half sine wave, $T_C = 85\text{ °C}$ , Double side cooled			420	A
Max. RMS on-state current	$I_{T(RMS)}$				650	A
Max. peak non-repetitive surge on-state current	$I_{TSM}$	$t_p = 10\text{ ms}$ , $T_j = 115\text{ °C}$ , sine wave after surge: $V_D = V_R = 0\text{ V}$			$8.8 \times 10^3$	A
Limiting load integral	$I^2t$				$387 \times 10^3$	A <sup>2</sup> s
Max. peak non-repetitive surge on-state current	$I_{TSM}$	$t_p = 1\text{ ms}$ , $T_j = 115\text{ °C}$ , sine wave after surge: $V_D = V_R = 0\text{ V}$			$15.7 \times 10^3$	A
Limiting load integral	$I^2t$				$123 \times 10^3$	A <sup>2</sup> s
Critical rate of rise of on-state current	$di_T/dt_{cr}$	For higher $di_T/dt$ and current lower than 50 A an external retrigger pulse is required.			TBD	A/ $\mu$ s

#### Characteristic values

Parameter	Symbol	Conditions	min	typ	max	Unit
On-state voltage	$V_T$	$I_T = 1100\text{ A}$ , $T_j = 115\text{ °C}$			3	V
Threshold voltage	$V_{(T0)}$	$T_j = 115\text{ °C}$ $I_T = 200 \dots 2000\text{ A}$			1.65	V
Slope resistance	$r_T$				1.2	m $\Omega$

### Turn-on switching (see Fig. 23, 25)

#### Maximum rated values <sup>Note 1</sup>

Parameter	Symbol	Conditions	min	typ	max	Unit
Critical rate of rise of on-state current	$di_T/dt_{cr}$	$f = 500\text{ Hz}$ , $T_j = 115\text{ °C}$ , $I_T = 1100\text{ A}$ , $V_D = 2700\text{ V}$			360	A/ $\mu$ s

#### Characteristic values

Parameter	Symbol	Conditions	min	typ	max	Unit
Turn-on delay time	$t_{don}$	$V_D = 2700\text{ V}$ , $T_j = 115\text{ °C}$ $I_T = 1100\text{ A}$ , $di/dt = V_D / L_i$ $L_i = 7.5\text{ }\mu\text{H}$ $C_{CL} = 1\text{ }\mu\text{F}$ , $L_{CL} = 0.6\text{ }\mu\text{H}$			3	$\mu$ s
Turn-on delay time status feedback	$t_{don SF}$				7	$\mu$ s
Rise time	$t_r$				1	$\mu$ s
Turn-on energy per pulse	$E_{on}$				0.45	J

### Turn-off switching (see Fig. 7, 8, 23, 25)

#### Maximum rated values <sup>Note 1</sup>

Parameter	Symbol	Conditions	min	typ	max	Unit
Max. controllable turn-off current	$I_{TGQM}$	$V_{DM} \leq V_{DRM}$ , $T_j = 115\text{ °C}$ , $V_D = 1900\text{ V}$ , $R_S = 1.25\text{ }\Omega$ , $C_{CL} = 1\text{ }\mu\text{F}$ , $L_{CL} \leq 0.6\text{ }\mu\text{H}$			1560	A
Max. controllable turn-off current	$I_{TGQM}$	$V_{DM} \leq V_{DRM}$ , $T_j = 115\text{ °C}$ , $V_D = 2700\text{ V}$ , $R_S = 1.25\text{ }\Omega$ , $C_{CL} = 1\text{ }\mu\text{F}$ , $L_{CL} \leq 0.6\text{ }\mu\text{H}$			1100	A

#### Characteristic values

Parameter	Symbol	Conditions	min	typ	max	Unit
Turn-off delay time	$t_{doff}$	$V_D = 2700\text{ V}$ , $T_j = 115\text{ °C}$ $V_{DM} \leq V_{DRM}$ , $R_S = 1.25\text{ }\Omega$ $I_{TGQ} = 1100\text{ A}$ , $L_i = 7.5\text{ }\mu\text{H}$ $C_{CL} = 1\text{ }\mu\text{F}$ , $L_{CL} = 0.6\text{ }\mu\text{H}$			6	$\mu$ s
Turn-off delay time status feedback	$t_{doff SF}$				7	$\mu$ s
Turn-off energy per pulse	$E_{off}$				5	J

## Diode Data

**On-state** (see Fig. 9 to 12, 24, 25)

**Maximum rated values** Note 1

Parameter	Symbol	Conditions	min	typ	max	Unit
Max. average on-state current	$I_{F(AV)M}$	Half sine wave, $T_C = 85\text{ °C}$			160	A
Max. RMS on-state current	$I_{F(RMS)}$				255	A
Max. peak non-repetitive surge current	$I_{FSM}$	$t_p = 10\text{ ms}$ , $T_{vj} = 115\text{ °C}$ , $V_R = 0\text{ V}$			$9.4 \times 10^3$	A
Limiting load integral	$I^2t$				$443 \times 10^3$	$A^2s$
Max. peak non-repetitive surge current	$I_{FSM}$	$t_p = 1\text{ ms}$ , $T_{vj} = 115\text{ °C}$ , $V_R = 0\text{ V}$			$23.8 \times 10^3$	A
Limiting load integral	$I^2t$				$283 \times 10^3$	$A^2s$

**Characteristic values**

Parameter	Symbol	Conditions	min	typ	max	Unit
On-state voltage	$V_F$	$I_F = 1100\text{ A}$ , $T_{vj} = 115\text{ °C}$			6.65	V
Threshold voltage	$V_{(F0)}$	$T_{vj} = 115\text{ °C}$			3.15	V
Slope resistance	$r_F$	$I_F = 200\text{...}2000\text{ A}$			3.2	$m\Omega$

**Turn-on** (see Fig. 24, 25)

**Characteristic values**

Parameter	Symbol	Conditions	min	typ	max	Unit
Peak forward recovery voltage	$V_{FRM}$	$di_F/dt = 350\text{ A}/\mu\text{s}$ , $T_{vj} = 115\text{ °C}$			80	V
		$di_F/dt = 1600\text{ A}/\mu\text{s}$ , $T_{vj} = 115\text{ °C}$			250	V

**Turn-off** (see Fig. 13 to 17, 24, 25)

**Maximum rated values** Note 1

Parameter	Symbol	Conditions	min	typ	max	Unit
Max. decay rate of on-state current	$di/dt_{crit}$	$I_{FM} = 1100\text{ A}$ , $T_{vj} = 115\text{ °C}$ $V_{DClink} = 2700\text{ V}$			425	$A/\mu\text{s}$

**Characteristic values**

Parameter	Symbol	Conditions	min	typ	max	Unit
Reverse recovery current	$I_{RM}$	$I_{FM} = 1100\text{ A}$ , $V_{DC-Link} = 2700\text{ V}$			460	A
Reverse recovery charge	$Q_{rr}$	$-di_F/dt = 360\text{ A}/\mu\text{s}$ , $L_{CL} = 0.6\text{ }\mu\text{H}$ $C_{CL} = 1\text{ }\mu\text{F}$ , $R_S = 1.25\text{ }\Omega$ ,			TBD	$\mu\text{C}$
Turn-off energy	$E_{rr}$	$T_{vj} = 115\text{ °C}$ , $D_{CL} = 5\text{SDF 03D4502}$			2.2	J

## Gate Unit Data

### Power supply (see Fig. 18, 19)

#### Maximum rated values <sup>Note 1</sup>

Parameter	Symbol	Conditions	min	typ	max	Unit
Gate Unit voltage (Connector X1)	$V_{GIN,RMS}$	AC square wave amplitude (15 kHz - 100kHz) or DC voltage. No galvanic isolation to power circuit.	28		40	V
Min. current needed to power up the Gate Unit	$I_{GIN Min}$	Rectified average current see application note 5SYA 2031	1.1			A
Gate Unit power consumption	$P_{GIN Max}$				80	W

#### Characteristic values

Parameter	Symbol	Conditions	min	typ	max	Unit
Internal current limitation	$I_{GIN Max}$	Rectified average current limited by the Gate Unit			7	A

### Optical control input/output <sup>2)</sup> (see Fig. 23)

#### Maximum rated values <sup>Note 1</sup>

Parameter	Symbol	Conditions	min	typ	max	Unit
Min. on-time	$t_{on}$		40			$\mu s$
Min. off-time	$t_{off}$		40			$\mu s$

#### Characteristic values

Parameter	Symbol	Conditions	min	typ	max	Unit
Optical input power	$P_{on CS}$	CS: Command signal SF: Status feedback Valid for 1mm plastic optical fiber (POF)	-15		-1	dBm
Optical noise power	$P_{off CS}$				-45	dBm
Optical output power	$P_{on SF}$				-1	dBm
Optical noise power	$P_{off SF}$				-50	dBm
Pulse width threshold	$t_{GLITCH}$	Max. pulse width without response			400	ns
External retrigger pulse width	$t_{retrig}$		600		1100	ns

2) Do not disconnect or connect fiber optic cables while light is on.

### Connectors <sup>2)</sup> (see Fig. 20 to 22)

Parameter	Symbol	Description
Gate Unit power connector	X1	AMP: MTA-156, Part Number 641210-5 <sup>3)</sup>
LWL receiver for command signal	CS	Avago, Type HFBR-2528 <sup>4)</sup>
LWL transmitter for status feedback	SF	Avago, Type HFBR-1528 <sup>4)</sup>

2) Do not disconnect or connect fiber optic cables while light is on.

3) AMP, [www.amp.com](http://www.amp.com)

4) Avago Technologies, [www.avagotech.com](http://www.avagotech.com)

### Visual feedback (see Fig. 22)

Parameter	Symbol	Description	Color
Gate OFF	LED1	"Light" when GCT is off	(green)
Gate ON	LED2	"Light" when gate-current is flowing	(yellow)
Fault	LED3	"Light" when not ready / Failure	(red)
Power supply voltage OK	LED4	"Light" when power supply is within specified range	(green)

# Thermal

Maximum rated values <sup>Note 1</sup>

Parameter	Symbol	Conditions	min	typ	max	Unit
Junction operating temperature	T <sub>vj</sub>		0		115	°C
Storage temperature range	T <sub>stg</sub>		-40		60	°C
Ambient operational temperature	T <sub>a</sub>		0		60	°C

## Characteristic values

Parameter	Symbol	Conditions	min	typ	max	Unit
Thermal resistance junction-to-case of GCT	R <sub>th(jc)</sub>	Double side cooled			25	K/kW
Thermal resistance case-to-heatsink of GCT	R <sub>th(ch)</sub>	Diode not dissipating			8	K/kW
Thermal resistance junction-to-case of Diode	R <sub>th(jc)</sub>	Double side cooled			42	K/kW
Thermal resistance case-to-heatsink of Diode	R <sub>th(ch)</sub>	GCT not dissipating			8	K/kW

Analytical function for transient thermal impedance:

$$Z_{thJC}(t) = \sum_{i=1}^n R_i(1 - e^{-t/\tau_i})$$

### GCT

i	1	2	3	4
R <sub>i</sub> (K/kW)	15.264	5.708	2.589	1.442
τ <sub>i</sub> (s)	0.4794	0.0745	0.0071	0.0021

### Diode

i	1	2	3	4
R <sub>i</sub> (K/kW)	25.179	9.918	4.345	2.565
τ <sub>i</sub> (s)	0.4936	0.0788	0.0071	0.0021

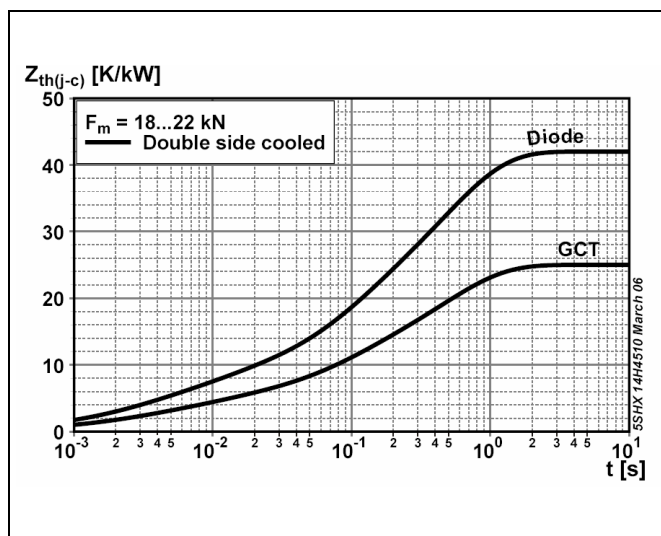


Fig. 1 Transient thermal impedance (junction-to-case) vs. time (max. values)

### Max. Turn-off current for Lifetime operation

- calculated lifetime of on-board capacitors 20 years
- with slightly forced air cooling (air velocity > 0.5 m/s)
- strong air cooling allows for increased ambient temperature

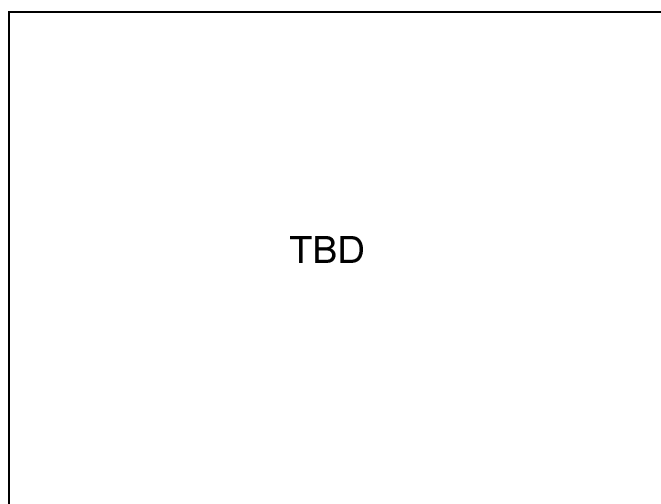
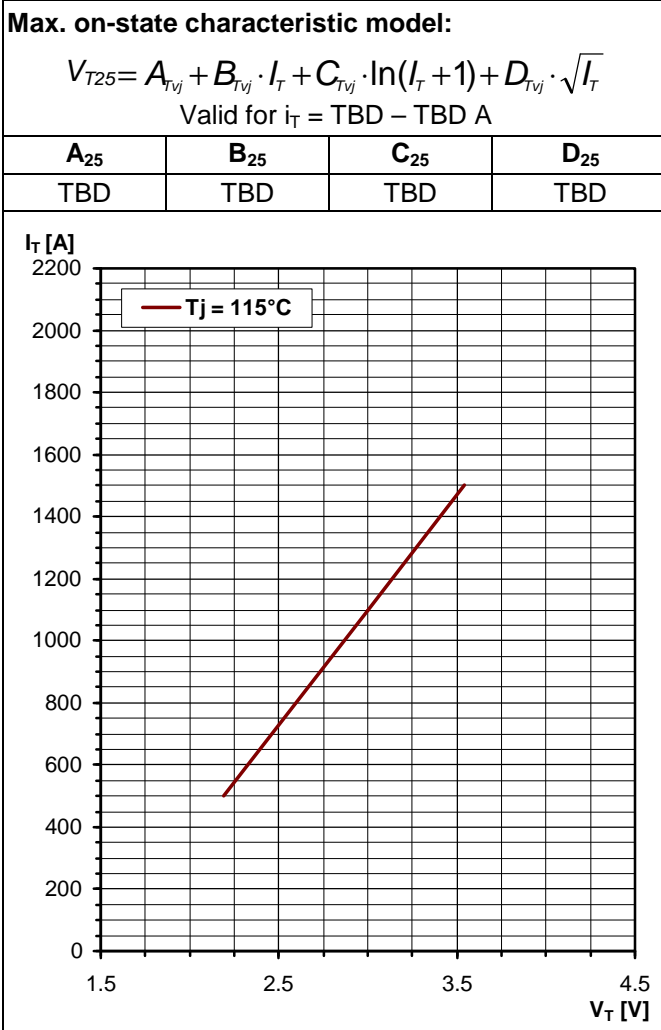
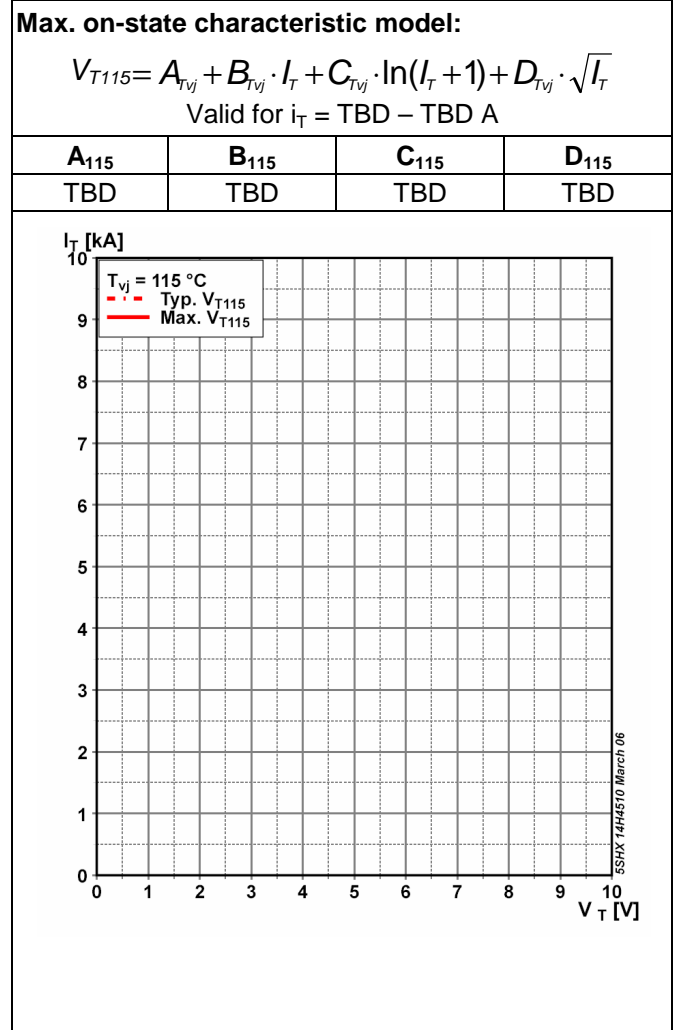


Fig. 2 Max. turn-off current vs. frequency for lifetime operation

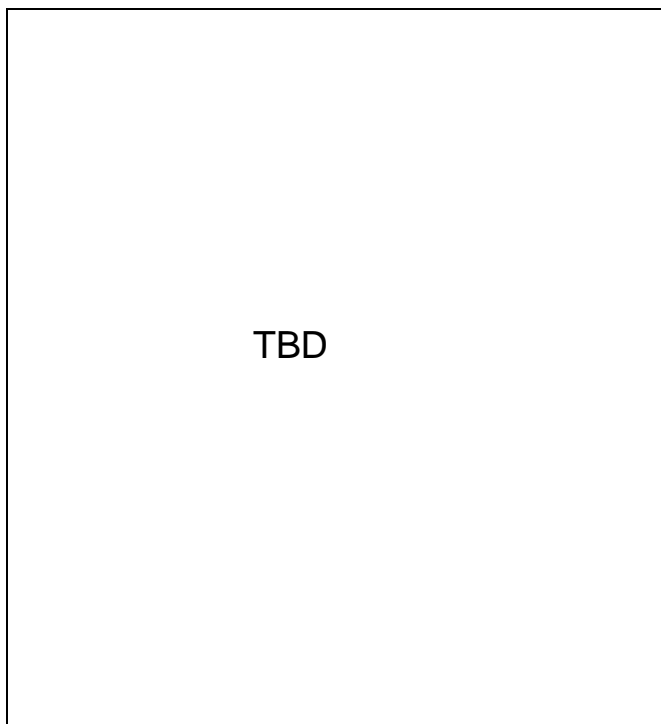
### GCT Part



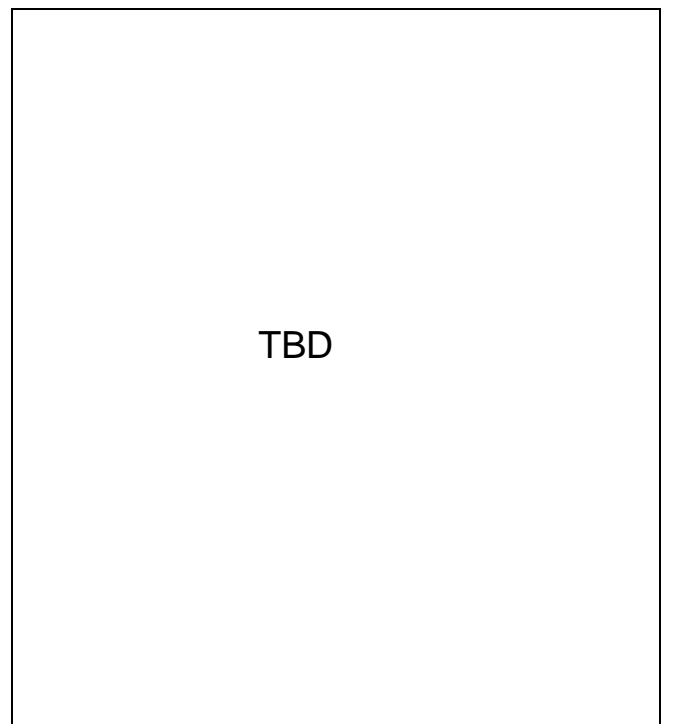
**Fig. 3** GCT on-state voltage characteristics



**Fig. 4** GCT on-state voltage characteristics



**Fig. 5** GCT surge on-state current vs. pulse length, half-sine wave



**Fig. 6** GCT surge on-state current vs. number of pulses, half-sine wave, 10 ms, 50Hz

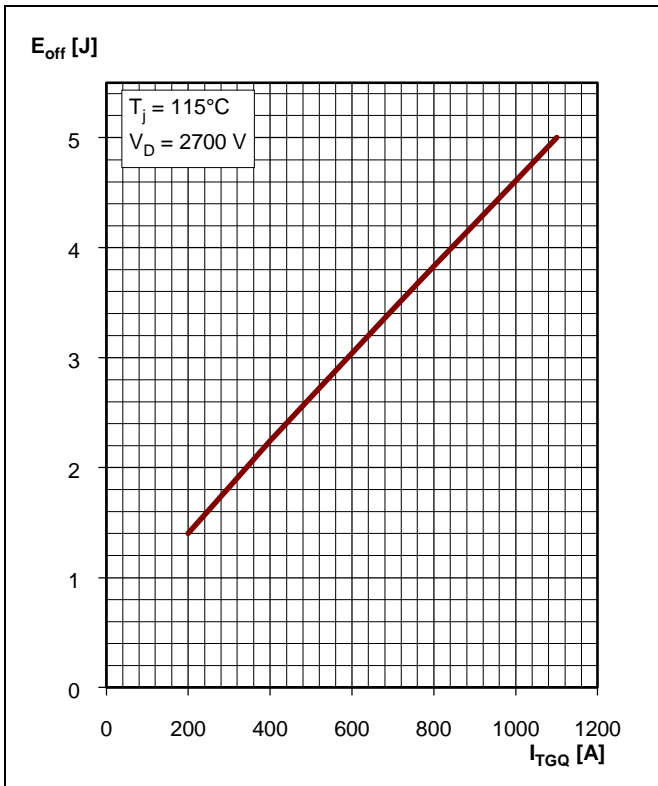


Fig. 7 GCT turn-off energy per pulse vs. turn-off current

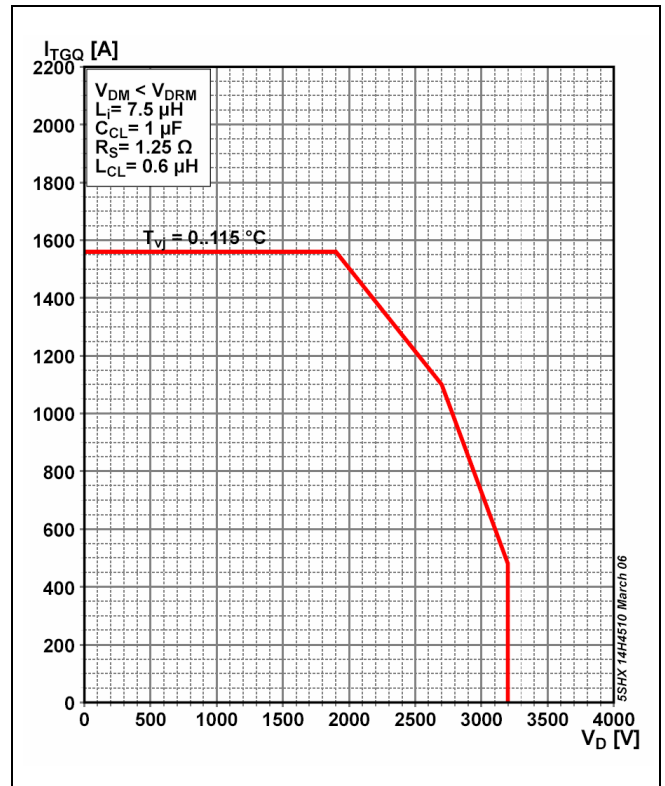


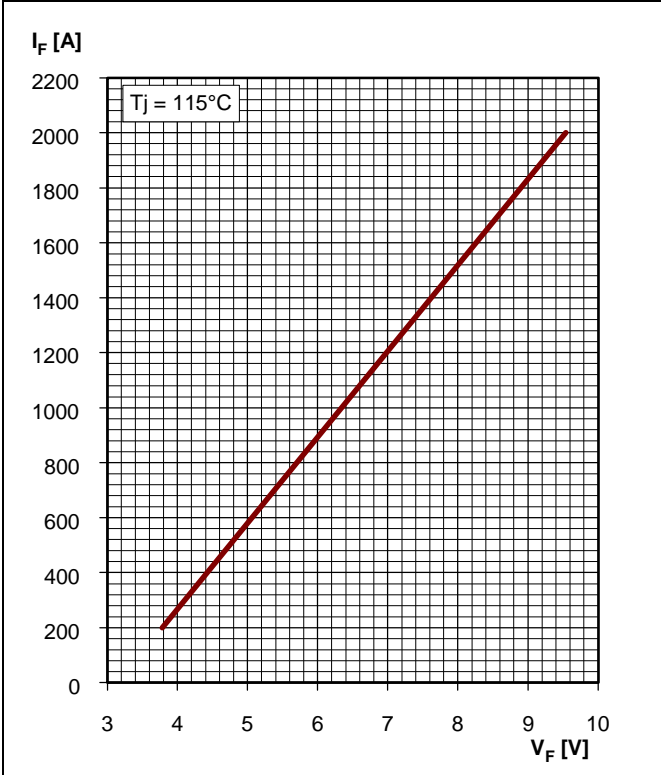
Fig. 8 GCT Safe Operating Area

# Diode Part

**Max. on-state characteristic model:**  

$$V_{F25} = A_{Tvj} + B_{Tvj} \cdot I_T + C_{Tvj} \cdot \ln(I_T + 1) + D_{Tvj} \cdot \sqrt{I_T}$$
 Valid for  $I_F = \text{TBD} - \text{TBD A}$

<b>A<sub>25</sub></b>	<b>B<sub>25</sub></b>	<b>C<sub>25</sub></b>	<b>D<sub>25</sub></b>
TBD	TBD	TBD	TBD

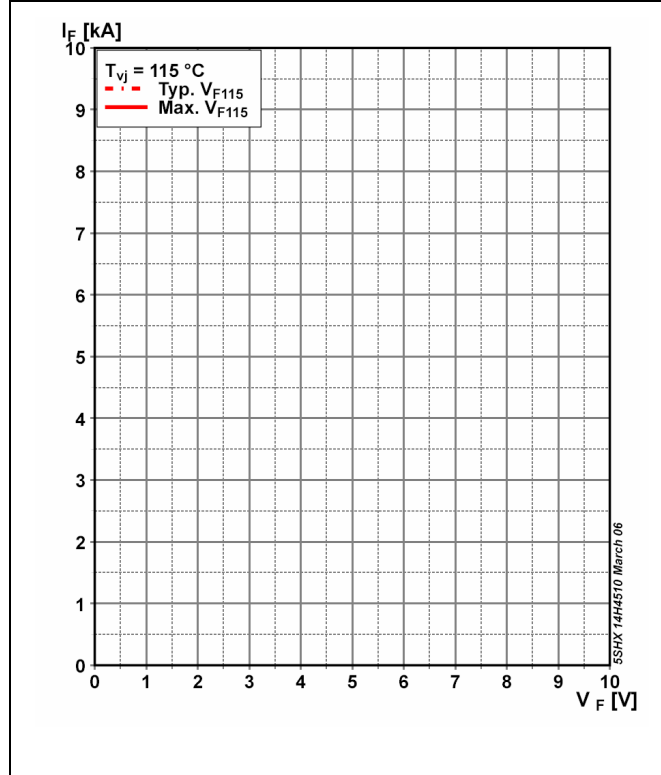


**Fig. 9** Diode on-state voltage characteristics

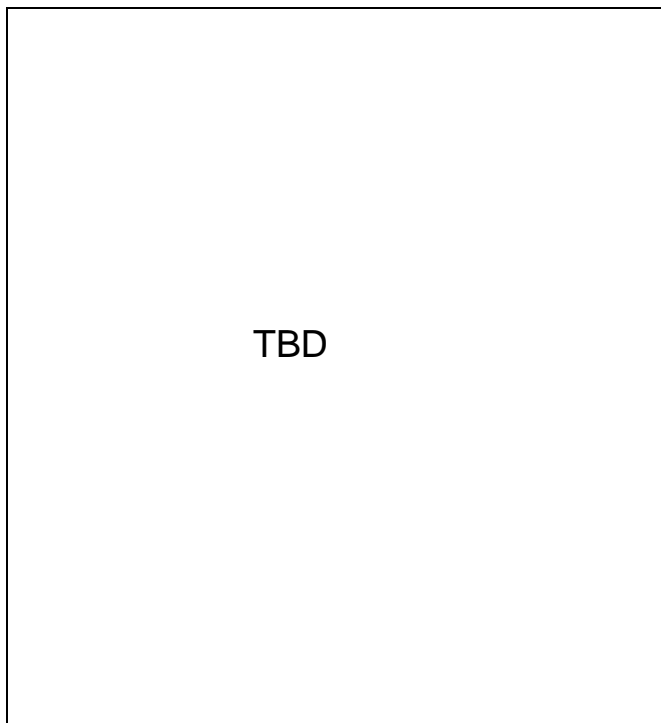
**Max. on-state characteristic model:**  

$$V_{F115} = A_{Tvj} + B_{Tvj} \cdot I_T + C_{Tvj} \cdot \ln(I_T + 1) + D_{Tvj} \cdot \sqrt{I_T}$$
 Valid for  $I_T = \text{TBD} - \text{TBD A}$

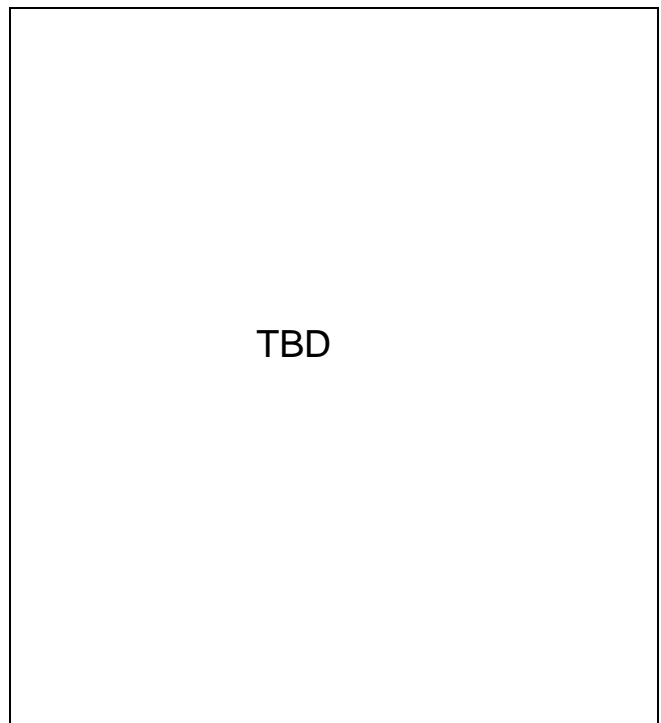
<b>A<sub>115</sub></b>	<b>B<sub>115</sub></b>	<b>C<sub>115</sub></b>	<b>D<sub>115</sub></b>
TBD	TBD	TBD	TBD



**Fig. 10** Diode on-state voltage characteristics

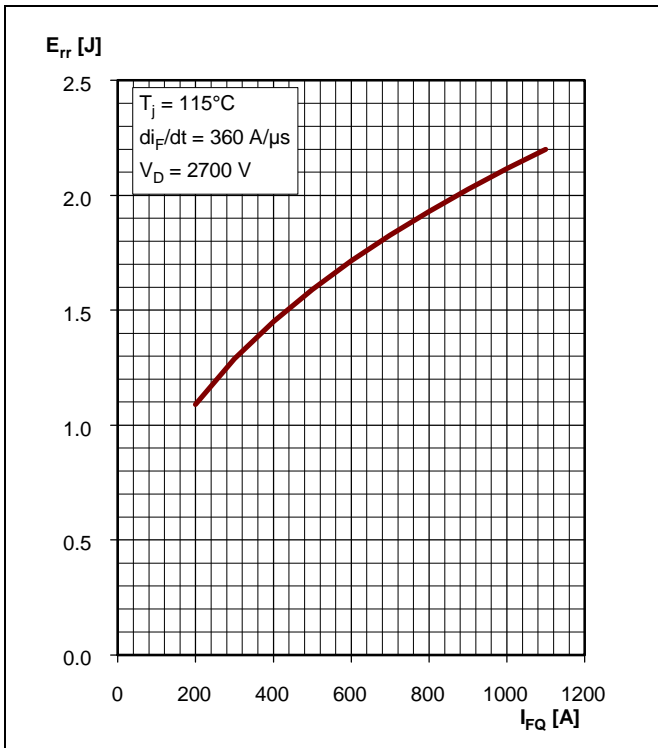


**Fig. 11** Diode surge on-state current vs. pulse length, half-sine wave

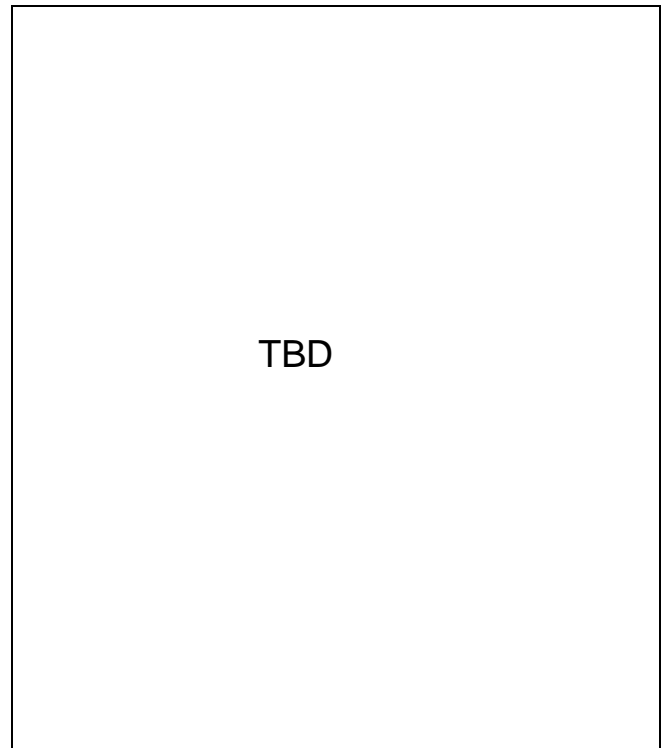


**Fig. 12** Diode surge on-state current vs. number of pulses, half-sine wave, 10 ms, 50Hz

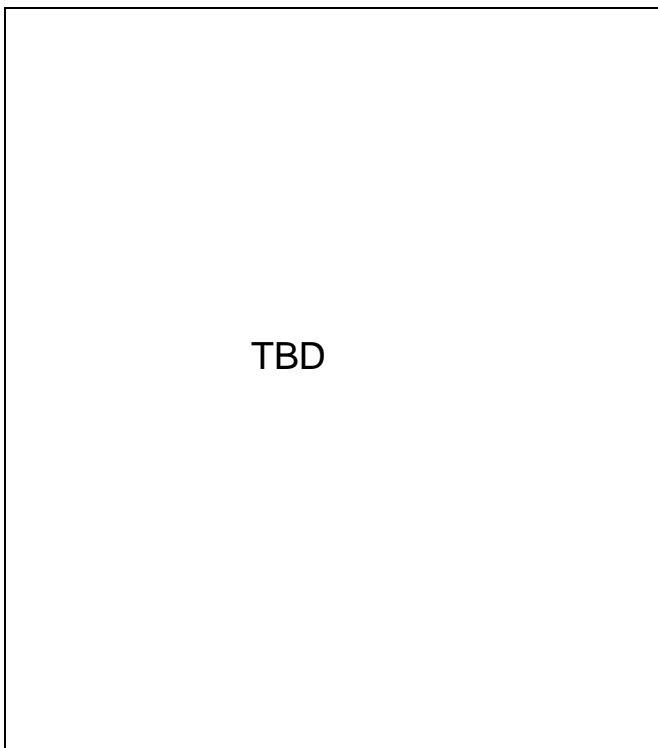




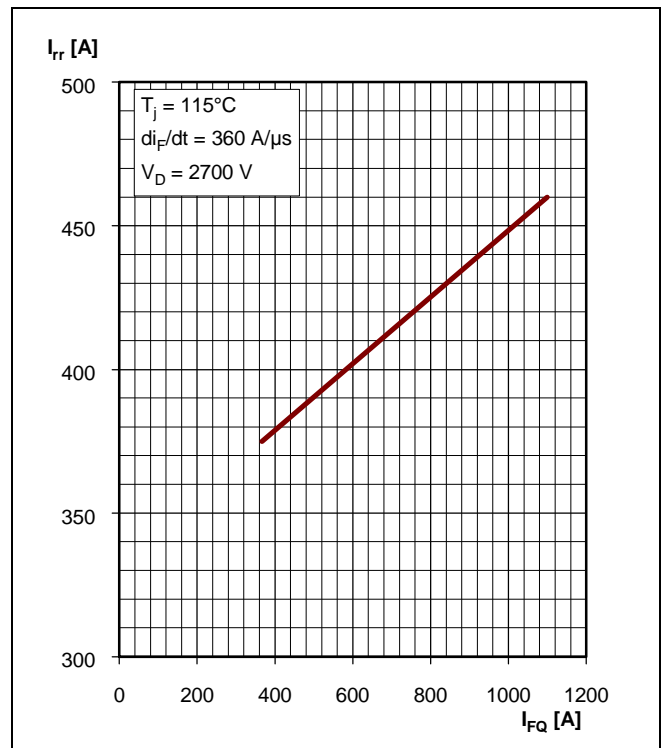
**Fig. 13** Upper scatter range of diode turn-off energy per pulse vs. turn-off current



**Fig. 14** Upper scatter range of diode turn-off energy per pulse vs decay rate of on-state current



**Fig. 15** Upper scatter range of diode reverse recovery charge vs decay rate of on-state current



**Fig. 16** Upper scatter range of diode reverse recovery current vs decay rate of on-state current

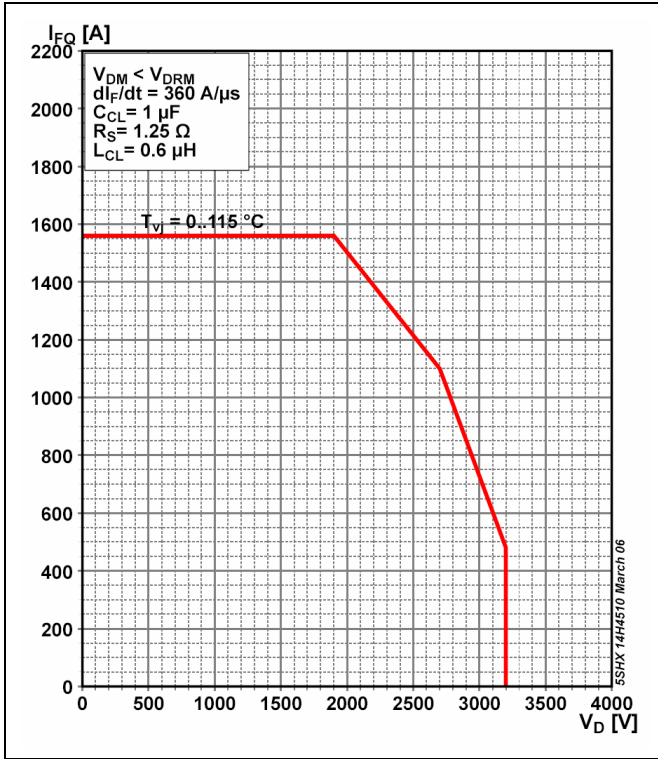


Fig. 17 Diode Safe Operating Area

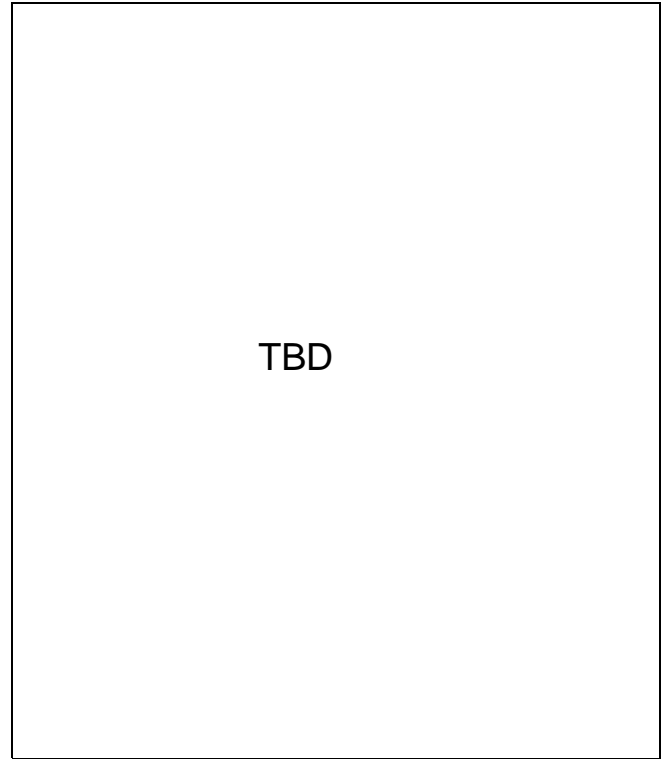


Fig. 18 Max. Gate Unit input power in chopper mode

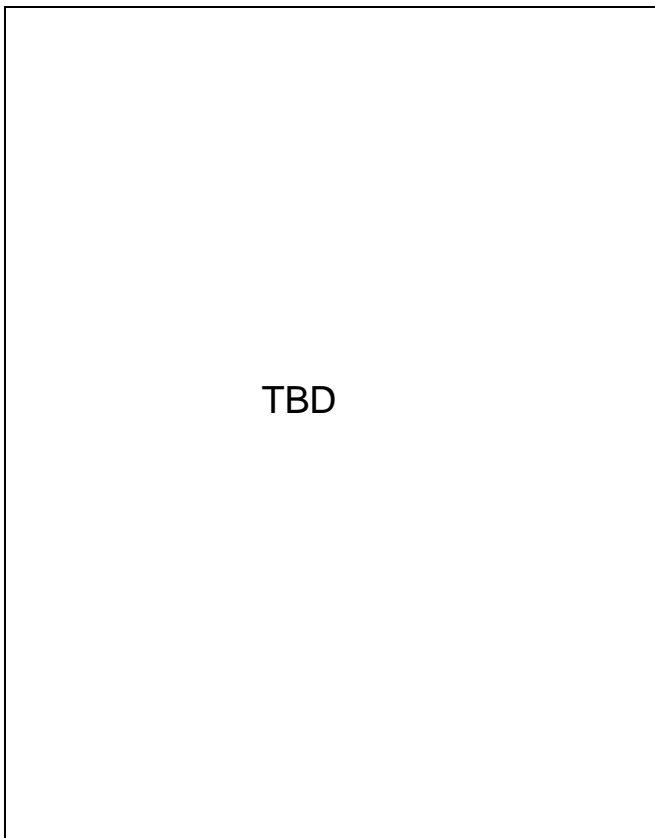


Fig. 19 Burst capability of Gate Unit

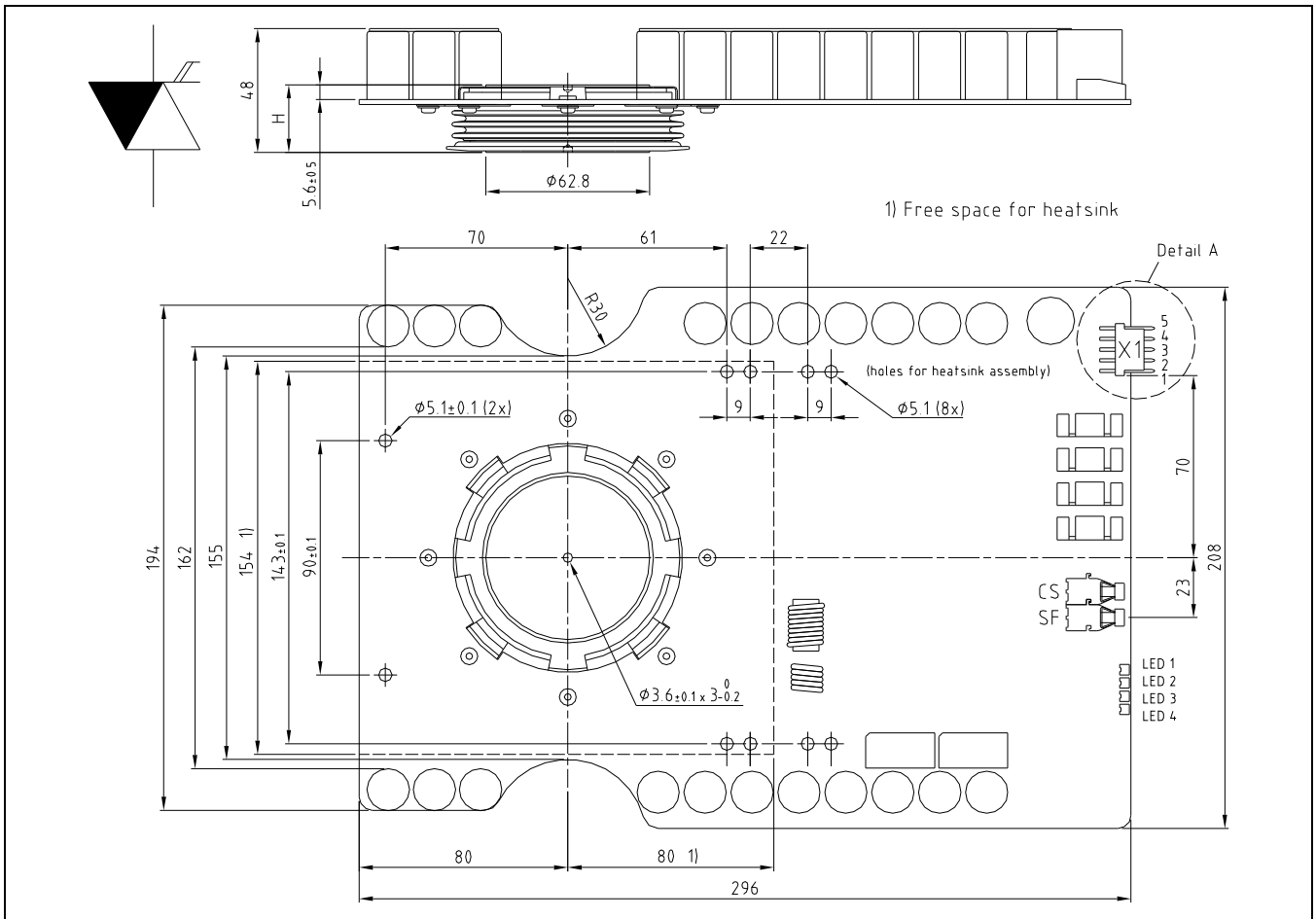


Fig. 20 Outline drawing; all dimensions are in millimeters and represent nominal values unless stated otherwise

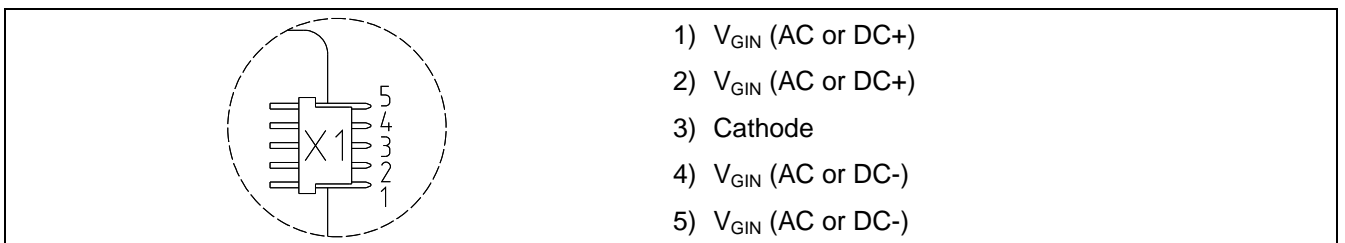


Fig. 21 Detail A: pin out of supply connector X1.

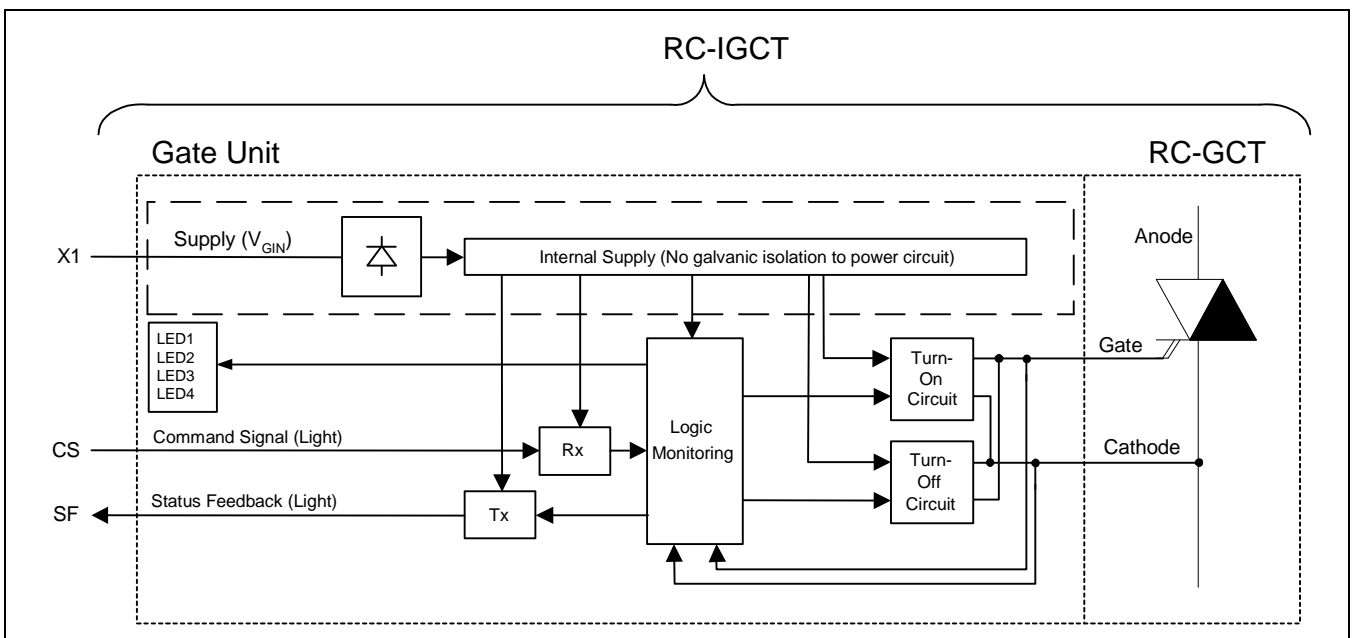


Fig. 22 Block diagram

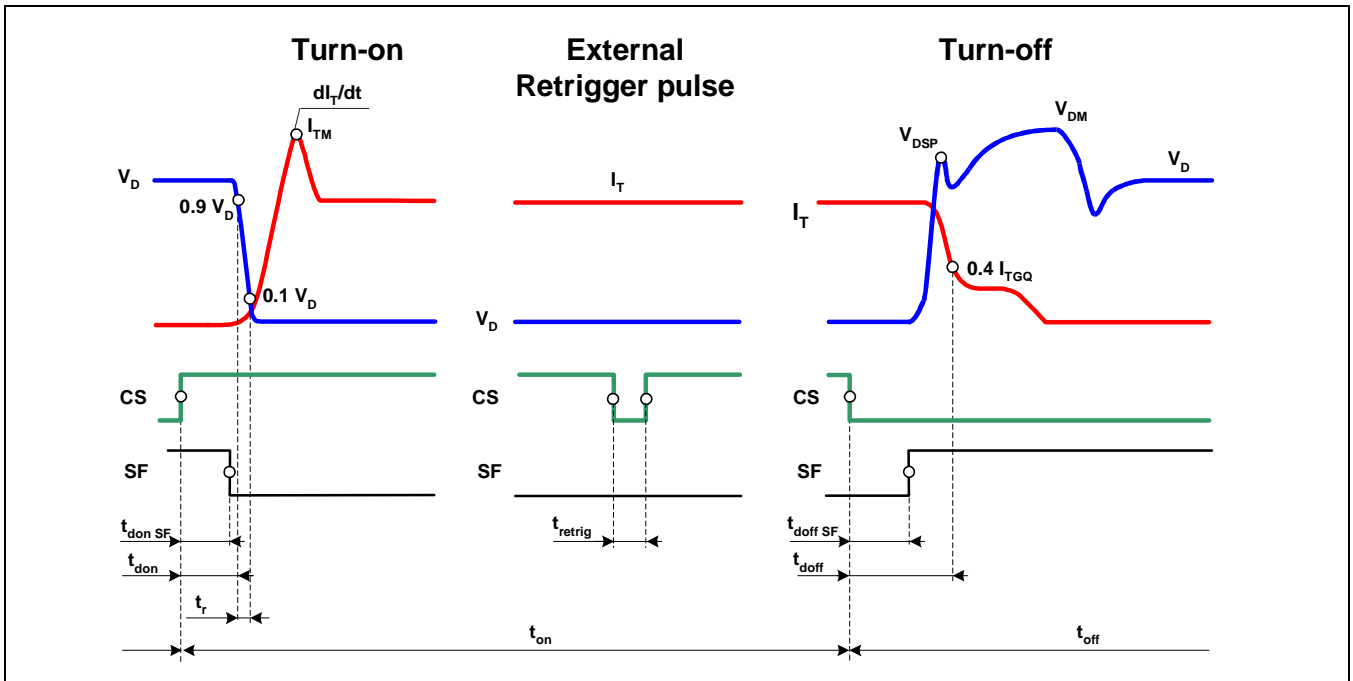


Fig. 23 General current and voltage waveforms with IGCT-specific symbols

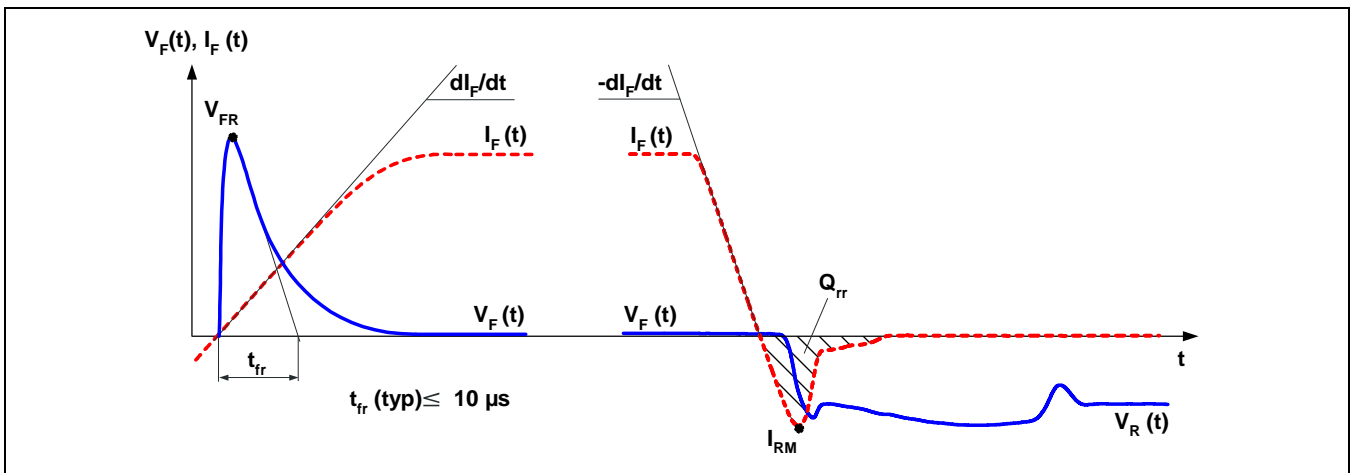
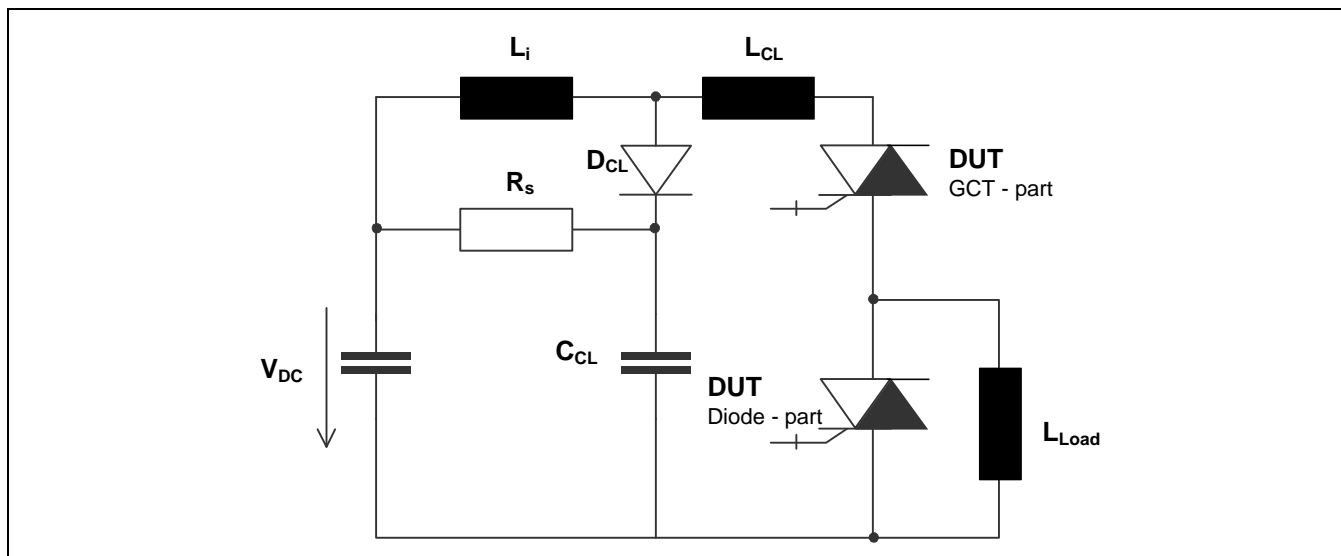


Fig. 24 General current and voltage waveforms with Diode-specific symbols



**Fig. 25** Test circuit

### Related documents:

5SYA 2031	Applying IGCT Gate Units
5SYA 2032	Applying IGCTs
5SYA 2036	Recommendations regarding mechanical clamping of Press Pack High Power Semiconductors
5SYA 2046	Failure rates of IGCTs due to cosmic rays
5SYA 2048	Field measurements on High Power Press Pack Semiconductors
5SYA 2051	Voltage ratings of high power semiconductors
5SZK 9107	Specification of environmental class for pressure contact IGCTs, OPERATION available on request, please contact factory

Please refer to <http://www.abb.com/semiconductors> for current version of documents.

**ABB Switzerland Ltd, Semiconductors reserves the right to change specifications without notice.**



**ABB Switzerland Ltd**  
**Semiconductors**  
 Fabrikstrasse 3  
 CH-5600 Lenzburg, Switzerland

Doc. No. 5SYA1227-05 Aug 07

Telephone +41 (0)58 586 1419  
 Fax +41 (0)58 586 1306  
 Email [abbsem@ch.abb.com](mailto:abbsem@ch.abb.com)  
 Internet [www.abb.com/semiconductors](http://www.abb.com/semiconductors)