

**PLEASE CHECK WWW.MOLEX.COM FOR LATEST PART INFORMATION**

**Part Number:** [0872645053](#)  
**Status:** **Active**  
**Description:** 2.00mm (.079") Pitch Milli-Grid™ Receptacle, Side Entry, Through Hole, 0.76µm (30µ") Gold (Au) Selective, 50 Circuits, Leadfree

**Documents:**

[3D Model](#) [Product Specification PS-87264 \(PDF\)](#)  
[Drawing \(PDF\)](#) [RoHS Certificate of Compliance \(PDF\)](#)

**Agency Certification**

CSA LR19980  
 UL E29179

**General**

Product Family PCB Receptacles  
 Series [87264](#)  
 Application Board-to-Board  
 Product Literature Order No 987650-1991  
 Product Name Milli-Grid™

**Physical**

Circuits (Loaded) 50  
 Color - Resin Black  
 Durability (mating cycles max) 25  
 Flammability 94V-0  
 Glow-Wire Compliant No  
 Lock to Mating Part None  
 Material - Metal Phosphor Bronze  
 Material - Plating Mating Gold  
 Material - Plating Termination Tin  
 Material - Resin High Temperature Thermoplastic  
 Number of Rows 2  
 Orientation Right Angle  
 PC Tail Length (in) 0.100 In  
 PC Tail Length (mm) 2.55 mm  
 PCB Locator No  
 PCB Retention None  
 PCB Thickness Recommended (in) 0.062 In  
 PCB Thickness Recommended (mm) 1.60 mm  
 Packaging Type Tube  
 Pitch - Mating Interface (in) 0.079 In  
 Pitch - Mating Interface (mm) 2.00 mm  
 Plating min: Mating (µin) 30.4  
 Plating min: Mating (µm) 0.76  
 Plating min: Termination (µin) 101.6  
 Plating min: Termination (µm) 2.54  
 Polarized to PCB No  
 Surface Mount Compatible (SMC) Yes  
 Temperature Range - Operating -55°C to +105°C  
 Termination Interface: Style Surface Mount

**Electrical**

Current - Maximum per Contact 1A  
 Voltage - Maximum 125V

**Solder Process Data**

Lead-free Process Capability Wave Capable (TH only)

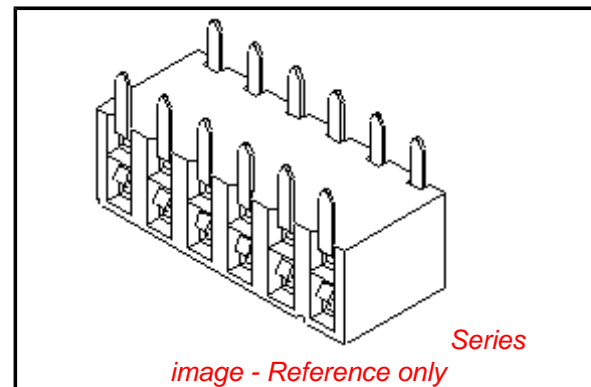

**EU RoHS**

**ELV and RoHS Compliant**  
**REACH SVHC Contains SVHC: No**  
**Halogen-Free Status**  
**Not Reviewed**

**China RoHS**



**Need more information on product environmental compliance?**

Email [productcompliance@molex.com](mailto:productcompliance@molex.com)  
 For a multiple part number RoHS Certificate of Compliance, [click here](#)

Please visit the [Contact Us](#) section for any non-product compliance questions.

**Search Parts in this Series**

[87264Series](#)

**Mates With**

[87758](#) , [87759](#) , [87760](#)

Process Temperature max. C 260

**Material Info**

**Reference - Drawing Numbers**

Product Specification  
Sales Drawing

PS-87264  
SD-87264-\*\*50

This document was generated on 03/18/2010

**PLEASE CHECK [WWW.MOLEX.COM](http://WWW.MOLEX.COM) FOR LATEST PART INFORMATION**

10 9 8 7 6 5 4 3 2 1

F

E

D

C

B

A

F

E

D

C

B

A

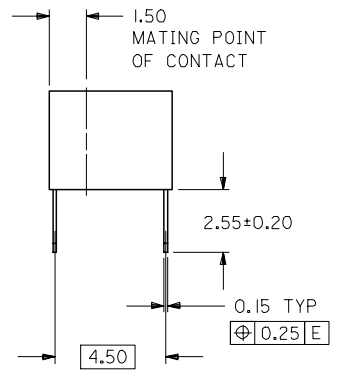
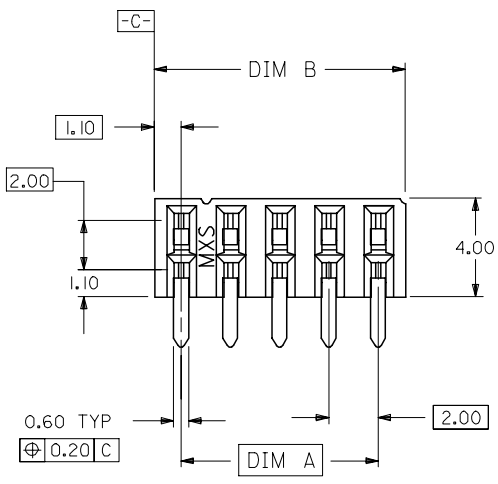

PART NO. LEGEND

87264- \* \* 5 \*  
CIRCUIT SIZE PLATING  
POST-PLATED

- 2 - 0.38um/15uin MIN. GOLD PLATE IN SELECTED AREA AND 2.54um/100uin MIN. TIN IN SELECTED AREA OVER 1.27um/50uin NICKEL OVERALL ( IN TUBE).
- 3 - 0.76um/30uin MIN. GOLD PLATE IN SELECTED AREA AND 2.54um/100uin MIN. TIN IN SELECTED AREA OVER 1.27um/50uin NICKEL OVERALL ( IN TUBE).
- 8 - 0.38um/15uin MIN. GOLD PLATE IN SELECTED AREA AND 2.54um/100uin MIN. TIN IN SELECTED AREA OVER 1.27um/50uin NICKEL OVERALL. (IN TAPE/REEL)
- 9 - 0.76um/30uin MIN. GOLD PLATE IN SELECTED AREA AND 2.54um/100uin MIN. TIN IN SELECTED AREA OVER 1.27um/50uin NICKEL OVERALL. (IN TAPE/REEL)

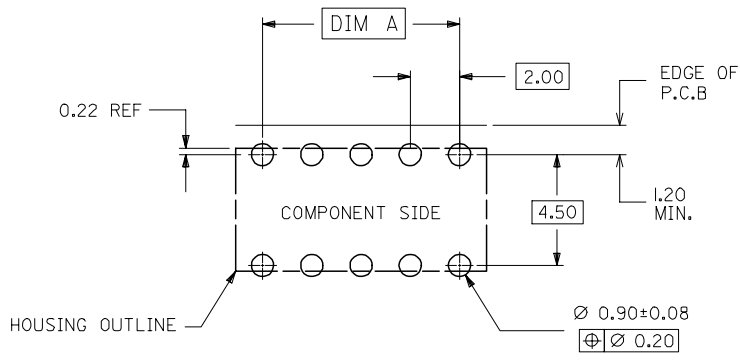
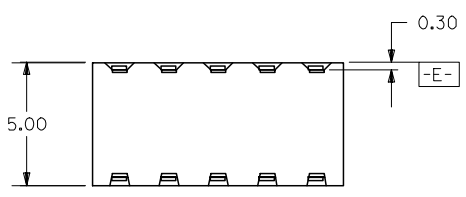

RECOMMENDED P.C. BOARD LAYOUT

- NOTES:
1. IO CIRCUIT SIZE SHOWN FOR ILLUSTRATION ONLY. SEE CHART FOR AVAILABLE PART SIZES.
  2. PLATING FINISH : TERMINAL - AS PER LEGEND
  3. RECOMMENDED PC BOARD THICKNESS IS 1.60 +/- 0.10mm.
  4. PRODUCT SPECIFICATION PS-87264 APPLIES.
  5. PART IS MATEABLE TO ALL MILLI-GRID HEADERS WITH MATING PIN LENGTH BETWEEN 2.50mm AND 4.20mm.
  6. TAPE & REEL OPTION IS SHOWN ON SHT 3 WITH 8 CKT ILLUSTRATION.
  7. PARTS SHALL BE PACKED IN MOISTURE BARRIER BAG.

ADD NOTE 7. EC NO: S2008-0422 DRWN:SKANG CHKD:ATSEE APPR:MLONG	2007/11/20 2007/11/20 2007/11/22	DESCRIPTION REV	QUALITY SYMBOLS	GENERAL TOLERANCES (UNLESS SPECIFIED)	DIMENSION STYLE	SCALE	DESIGN UNITS	THIRD ANGLE PROJECTION
			▽=0 ∇=0	mm INCH	MM ONLY	NTS	METRIC	
			4 PLACES ± --- ± ---	DRAWN BY DATE	TITLE	MGRID, 2MM DUAL ROW HDR. SIDE ENTRY RECEPTACLE T/H		
			3 PLACES ± --- ± ---	JWAN 1992/02/25		MOLEX INCORPORATED		
2 PLACES ± 0.2 ± ---	CHECKED BY DATE		DOCUMENT NO. SHEET NO.					
1 PLACE ± --- ± ---	MLA1 1992/02/25		SD-87264-***50 1 OF 3					
ANGULAR ± 3 °	APPROVED BY DATE		THIS DRAWING CONTAINS INFORMATION THAT IS PROPRIETARY TO MOLEX INCORPORATED AND SHOULD NOT BE USED WITHOUT WRITTEN PERMISSION					
	RWONG 1992/02/25							
	MATERIAL NO.							
	SIZE							
	A3							

9 8 7 6 5 4 3 2 1

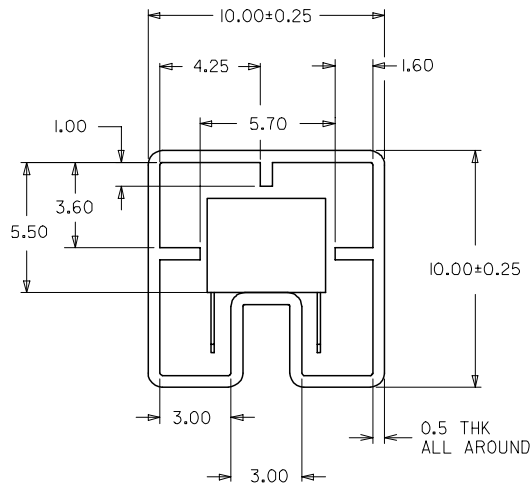
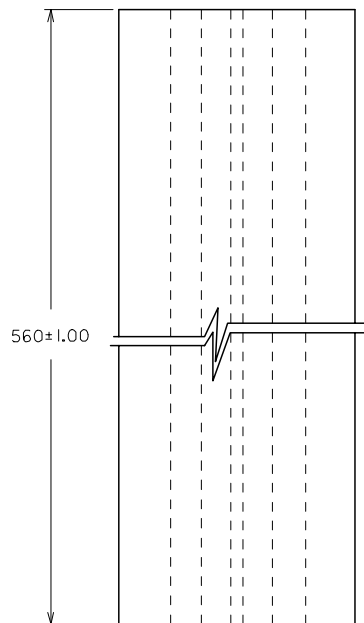

PART IN TUBE ORIENTATION.

PART NUMBER 0.38um GOLD PLATING $\triangle_2$	PART NUMBER 0.76um GOLD PLATING $\triangle_2$	CKT. SIZE	DIM A	DIM B
87264-065*	87264-065*	6	4.00	6.20
87264-085*	87264-085*	8	6.00	8.20
87264-105*	87264-105*	10	8.00	10.20
87264-125*	87264-125*	12	10.00	12.20
87264-145*	87264-145*	14	12.00	14.20
87264-165*	87264-165*	16	14.00	16.20
87264-185*	87264-185*	18	16.00	18.20
87264-205*	87264-205*	20	18.00	20.20
87264-225*	87264-225*	22	20.00	22.20
87264-245*	87264-245*	24	22.00	24.20
87264-265*	87264-265*	26	24.00	26.20
87264-285*	87264-285*	28	26.00	28.20
87264-305*	87264-305*	30	28.00	30.20
87264-325*	87264-325*	32	30.00	32.20
87264-345*	87264-345*	34	32.00	34.20
87264-365*	87264-365*	36	34.00	36.20
87264-385*	87264-385*	38	36.00	38.20
87264-405*	87264-405*	40	38.00	40.20
87264-425*	87264-425*	42	40.00	42.20
87264-445*	87264-445*	44	42.00	44.20
87264-465*	87264-465*	46	44.00	46.20
87264-485*	87264-485*	48	46.00	48.20
87264-505*	87264-505*	50	48.00	50.20

ADD NOTE 7. EC NO: S2008-0422 DRWNS:KANG 2007/11/20 CHKD:ATSEE 2007/11/20 APPR:MLONG 2007/11/22	QUALITY SYMBOLS $\blacktriangledown = 0$ $\triangle = 0$	GENERAL TOLERANCES (UNLESS SPECIFIED)		DIMENSION STYLE	SCALE	DESIGN UNITS	THIRD ANGLE PROJECTION	
				MM ONLY	NTS	METRIC		
		4 PLACES	$\pm$ ---	$\pm$ ---	DRAWN BY	DATE	MGRID, 2MM DUAL ROW HDR. SIDE ENTRY RECEPTACLE T/H	
		3 PLACES	$\pm$ ---	$\pm$ ---	JWAN	1992/02/25		
2 PLACES	$\pm$ 0.2	$\pm$ ---	2 PLACES	MLA1	1992/02/25	MOLEX INCORPORATED		
1 PLACE	$\pm$ ---	$\pm$ ---	1 PLACE	RWONG	1992/02/25			
		ANGULAR $\pm 3^\circ$		MATERIAL NO.		DOCUMENT NO.	SHEET NO.	
DRAFT WHERE APPLICABLE MUST REMAIN WITHIN DIMENSIONS		SEE TABLE		SD-87264-***50		2 OF 3		
				THIS DRAWING CONTAINS INFORMATION THAT IS PROPRIETARY TO MOLEX INCORPORATED AND SHOULD NOT BE USED WITHOUT WRITTEN PERMISSION				

PART NUMBER 0.38um GOLD PLATING $\triangle_2$ (IN TAPE/REEL)	PART NUMBER 0.76um GOLD PLATING $\triangle_2$ (IN TAPE/REEL)	CKT SIZE	DIM W	DIM F	DIM Bo
87264-085*	87264-085*	8	24.00	11.50	8.80

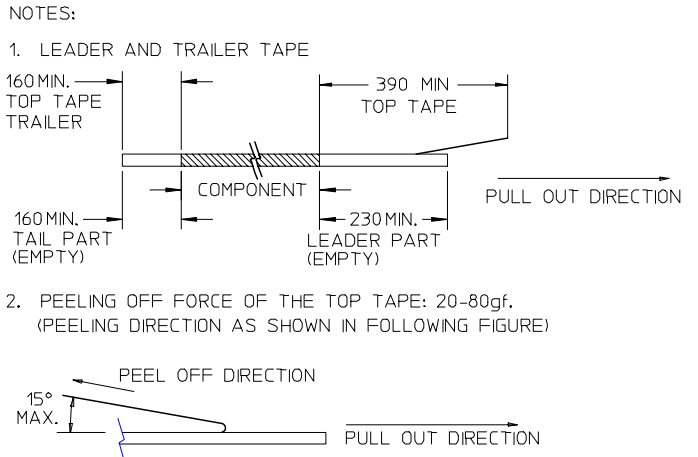
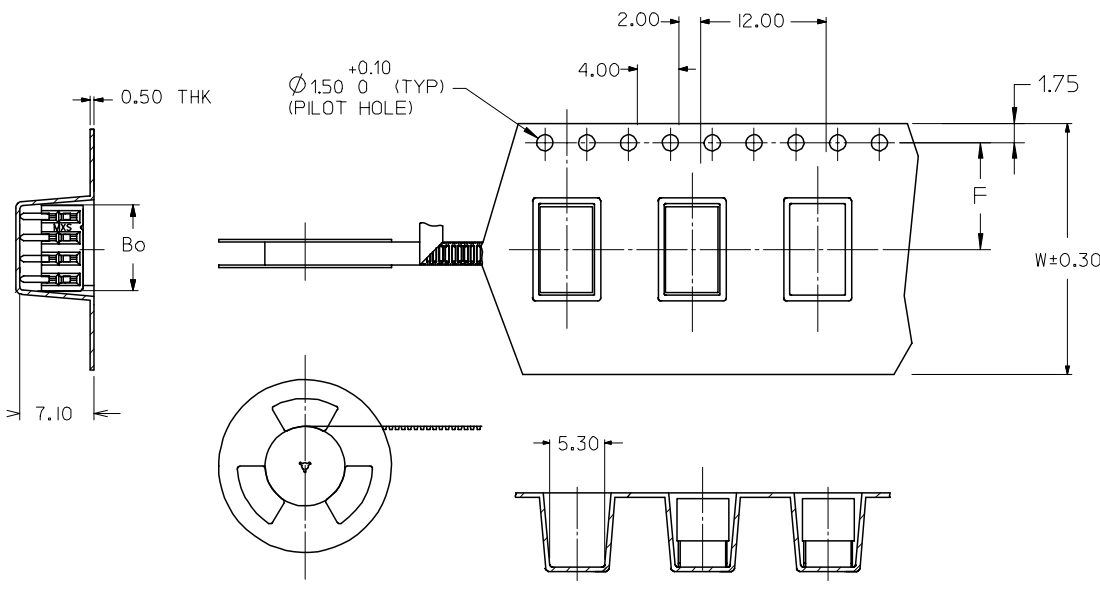

- PACKAGING STANDARD IS AS PER EIA-481.
- TAPE & REEL QUANTITY = 600PCS/REEL

CUSTOMER PULL OUT DIRECTION →

ADD NOTE 7. EC NO: S2008-0422 DRWNS:KANG 2007/11/20 CHKD:ATSEE 2007/11/20 APPR:MLONG 2007/11/22	QUALITY SYMBOLS	GENERAL TOLERANCES (UNLESS SPECIFIED)	DIMENSION STYLE	SCALE	DESIGN UNITS	THIRD ANGLE PROJECTION																		
	$\nabla=0$ $\triangle=0$	<table border="1"> <tr> <th></th> <th>mm</th> <th>INCH</th> </tr> <tr> <td>4 PLACES</td> <td>± ---</td> <td>± ---</td> </tr> <tr> <td>3 PLACES</td> <td>± ---</td> <td>± ---</td> </tr> <tr> <td>2 PLACES</td> <td>± 0.2</td> <td>± ---</td> </tr> <tr> <td>1 PLACE</td> <td>± ---</td> <td>± ---</td> </tr> <tr> <td colspan="3">ANGULAR ± 3 °</td> </tr> </table>		mm	INCH	4 PLACES	± ---	± ---	3 PLACES	± ---	± ---	2 PLACES	± 0.2	± ---	1 PLACE	± ---	± ---	ANGULAR ± 3 °			MM ONLY	NTS	METRIC	
		mm	INCH																					
	4 PLACES	± ---	± ---																					
3 PLACES	± ---	± ---																						
2 PLACES	± 0.2	± ---																						
1 PLACE	± ---	± ---																						
ANGULAR ± 3 °																								
DESCRIPTION	DRAWN BY	DATE	TITLE	MGRID, 2MM DUAL ROW HDR. SIDE ENTRY RECEPTACLE T/H MOLEX INCORPORATED																				
REV	JWAN	1992/02/25																						
	1	MLA1	1992/02/25	DOCUMENT NO. SD-87264-**-50 SHEET NO. 3 OF 3																				
		RWONG	1992/02/25	MATERIAL NO. SEE TABLE SIZE A3 THIS DRAWING CONTAINS INFORMATION THAT IS PROPRIETARY TO MOLEX INCORPORATED AND SHOULD NOT BE USED WITHOUT WRITTEN PERMISSION																				