

Silicon PNP Power Transistors

2SA1060

DESCRIPTION

- With TO-3PN package
- Complement to type 2SC2484
- High collector power dissipation

APPLICATIONS

- High power audio frequency amplifier

PINNING

PIN	DESCRIPTION
1	Base
2	Collector;connected to mounting base
3	Emitter

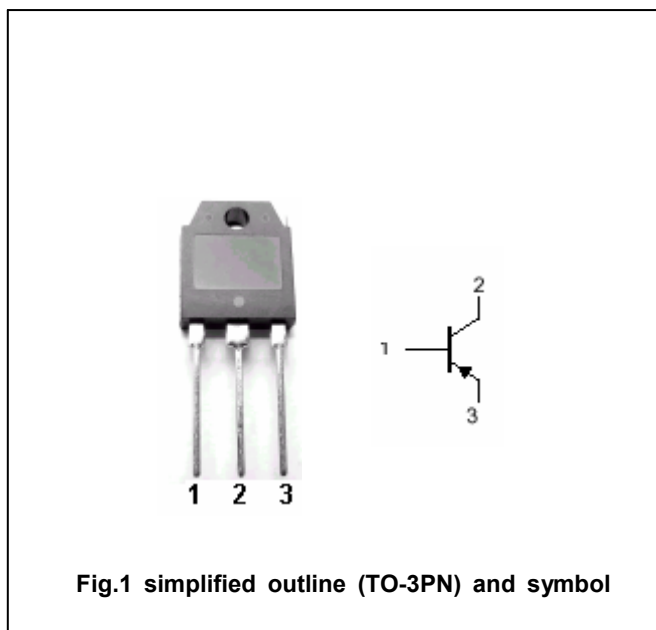

Fig.1 simplified outline (TO-3PN) and symbol

Absolute maximum ratings (Ta=25°C)

SYMBOL	PARAMETER	CONDITIONS	VALUE	UNIT
V _{CBO}	Collector-base voltage	Open emitter	-80	V
V _{CEO}	Collector-emitter voltage	Open base	-80	V
V _{EBO}	Emitter-base voltage	Open collector	-6	V
I _C	Collector current (DC)		-5	A
I _{CM}	Collector current-peak		-8	A
P _C	Collector power dissipation	T _C =25°C	60	W
T _j	Junction temperature		150	°C
T _{stg}	Storage temperature		-55~150	°C

Silicon PNP Power Transistors

2SA1060

CHARACTERISTICS

T_j=25°C unless otherwise specified

SYMBOL	PARAMETER	CONDITIONS	MIN	TYP.	MAX	UNIT
V _{(BR)CEO}	Collector-emitter breakdown voltage	I _C =-10mA ; I _B =0	-80			V
V _{CEsat}	Collector-emitter saturation voltage	I _C =-3A ; I _B =-0.3A			-2.0	V
V _{BE}	Base-emitter on voltage	I _C =-3A ; V _{CE} =-5V			-1.8	V
I _{CBO}	Collector cut-off current	V _{CB} =-80V ; I _E =0			-50	μA
I _{EBO}	Emitter cut-off current	V _{EB} =-3V ; I _C =0			-50	μA
h _{FE-1}	DC current gain	I _C =-20mA ; V _{CE} =-5V	20			
h _{FE-2}	DC current gain	I _C =-1A ; V _{CE} =-5V	40		200	
h _{FE-3}	DC current gain	I _C =-3A ; V _{CE} =-5V	20			
f _T	Transition frequency	I _C =-0.5A ; V _{CE} =-5V		20		MHz

◆ h_{FE-2} Classifications

R	Q	P
40-80	60-120	100-200

Silicon PNP Power Transistors

2SA1060

PACKAGE OUTLINE

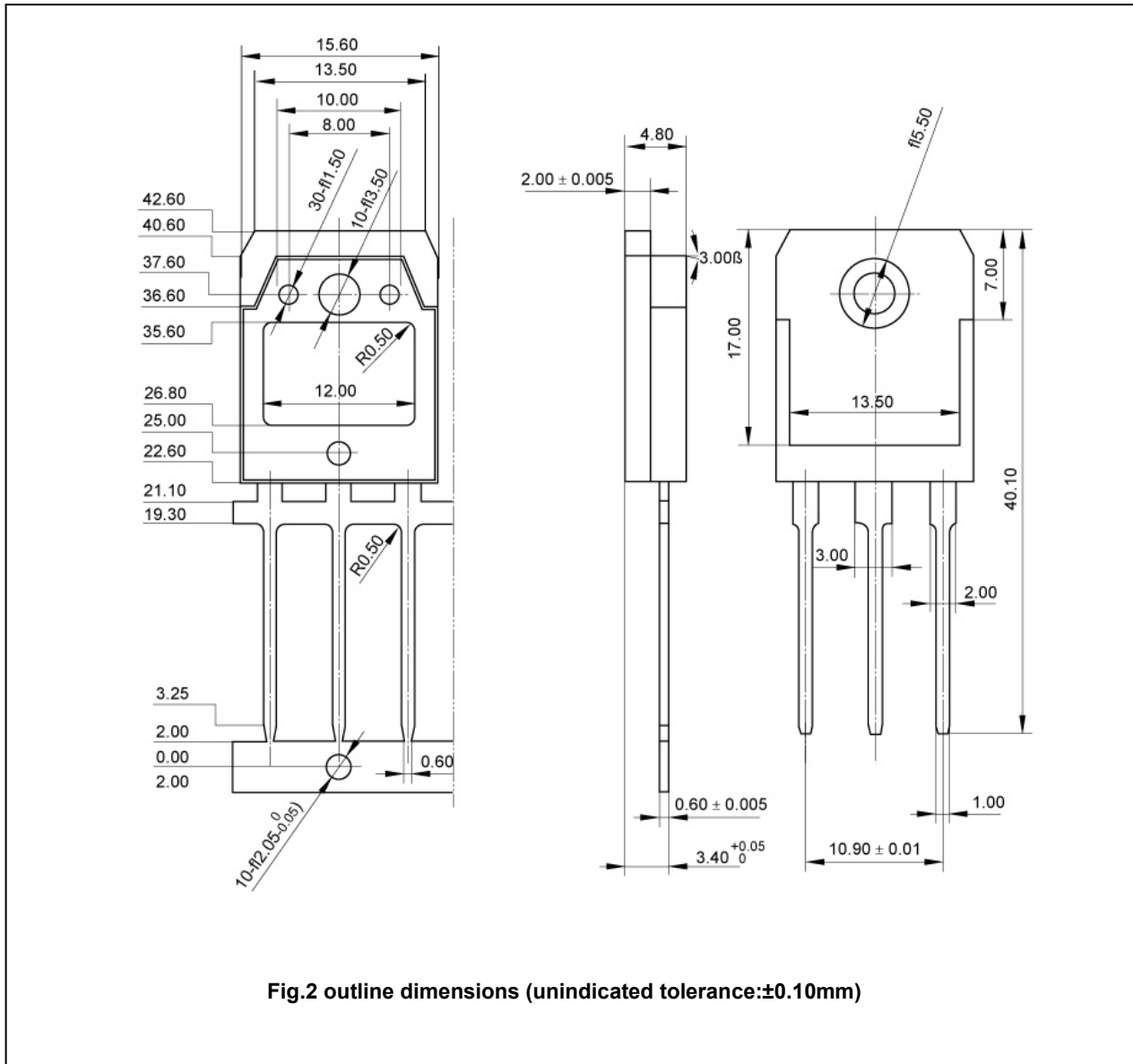

Fig.2 outline dimensions (unindicated tolerance: ± 0.10 mm)