

# HMC483MS8G / 483MS8GE

**HIGH IP3 GaAs MMIC MIXER with  
INTEGRATED LO AMPLIFIER, 0.7 - 1.4 GHz**

## Typical Applications

The HMC483MS8G / HMC483MS8GE is ideal for:

- Cellular/3G
- GSM, GPRS & EDGE
- CDMA & WCDMA
- Cable Modem Termination Systems

## Features

- +33 dBm Input IP3
- Conversion Loss: 9 dB
- Low LO Drive: -4 to +4 dBm
- Single Positive Supply: 5V @ 50 mA
- Ultra Small MSOP Package: 14.8mm<sup>2</sup>
- Included in the HMC-DK003 Designer's Kit

## Functional Diagram

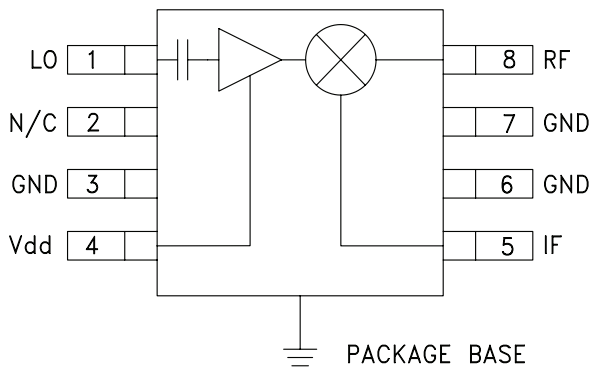

## General Description

The HMC483MS8G & HMC483MS8GE are high dynamic range passive MMIC mixers with integrated LO amplifiers in plastic surface mount 8 lead Mini Small Outline Packages (MSOP) covering 0.7 to 1.4 GHz. Excellent input IP3 performance of +33 dBm for down conversion and +30 dBm for up conversion is provided for 2.5G & 3G GSM/CDMA applications at an LO drive of 0 dBm. With an input 1 dB compression of +24 dBm, the RF port will accept a wide range of input signal levels. Conversion loss is 9.0 dB typical. The DC to 350 MHz IF frequency response will satisfy GSM/CDMA transmit or receive frequency plans configured for low side LO. The HMC483MS8G & HMC483MS8GE are pin for pin compatible with the HMC485MS8G & HMC485MS8GE which are 1.7 - 2.2 GHz mixers with LO amplifiers.

## Electrical Specifications, $T_A = +25^\circ\text{C}$ , LO = 0 dBm, IF = 70 MHz\*, Vdd = 5V

Parameter	Min.	Typ.	Max.	Min.	Typ.	Max.	Units
Frequency Range, RF & LO	0.8 - 1.1		0.7 - 1.4				GHz
Frequency Range, IF	DC - 350		DC - 350				MHz
Conversion Loss		8.5	10.5		9	12	dB
Noise Figure (SSB)		8.5	10.5		9	12	dB
LO to RF Isolation	10	20		6	14		dB
LO to IF Isolation	6	10		6	13		dB
IP3 (Input)		33			33		dBm
1 dB Gain Compression (Input)		24			23		dBm
LO Input Drive Level (Typical)	-4 to +4		-4 to +4				dBm
Supply Current		50			50		mA

\*Unless otherwise noted, all measurements performed as a downconverter.



MICROWAVE CORPORATION v00.0805



# HMC483MS8G / 483MS8GE

## HIGH IP3 GaAs MMIC MIXER with INTEGRATED LO AMPLIFIER, 0.7 - 1.4 GHz

### Conversion Gain vs. Temperature

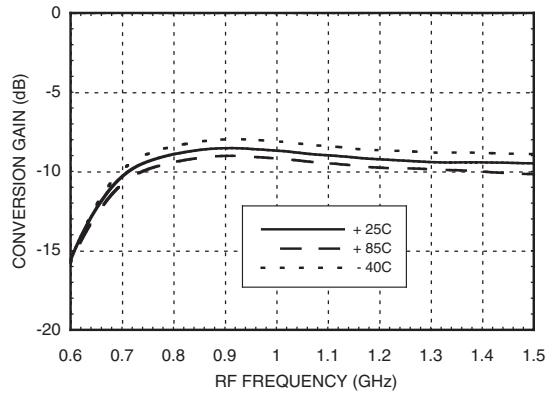

### Isolation

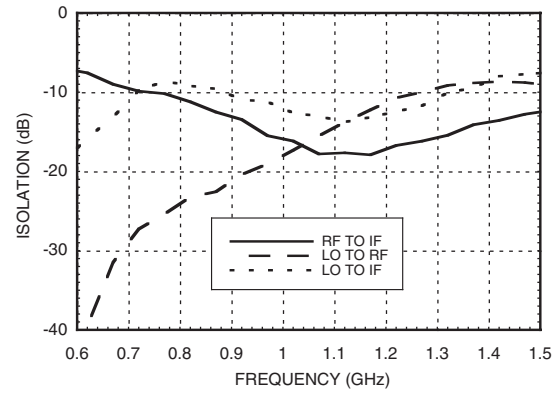

### Conversion Gain vs. LO Drive

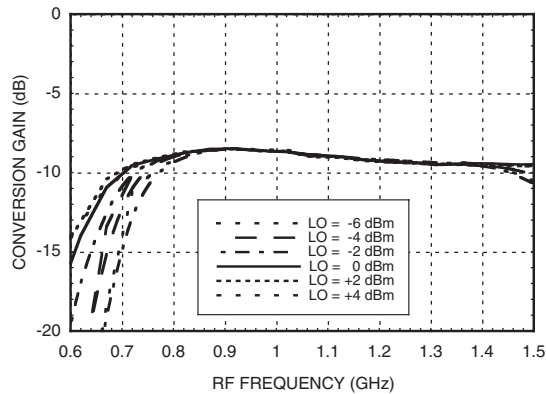

### Return Loss

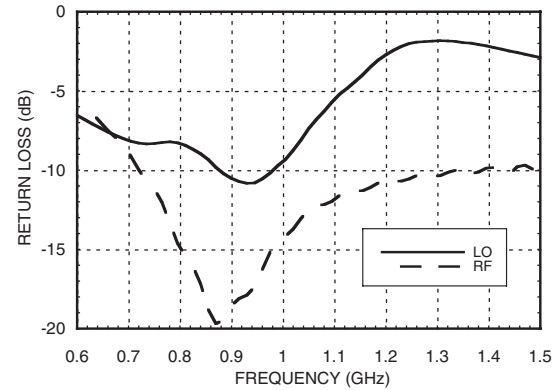

### Upconverter Performance Conversion Gain

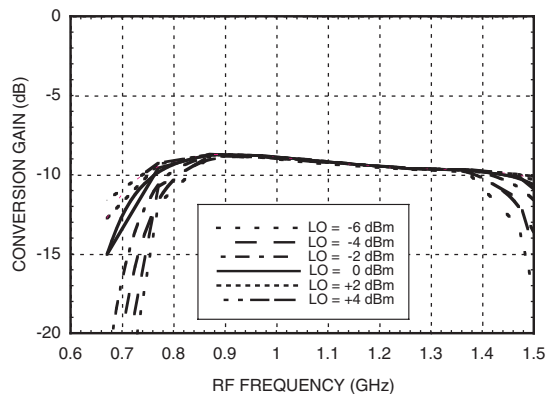

### IF Bandwidth

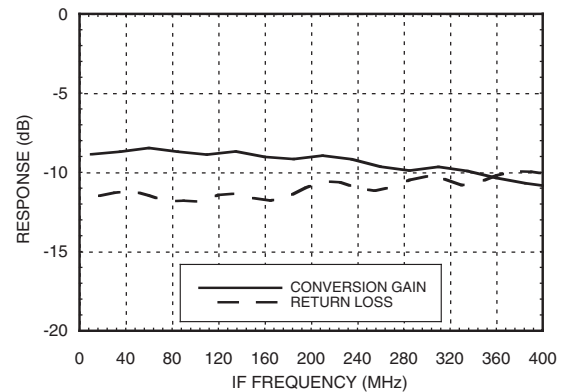

\*Unless otherwise noted, all measurements performed as a downconverter, with low side LO & IF = 70 MHz.



# HMC483MS8G / 483MS8GE

## HIGH IP3 GaAs MMIC MIXER with INTEGRATED LO AMPLIFIER, 0.7 - 1.4 GHz

**Input IP3 vs. Temperature**

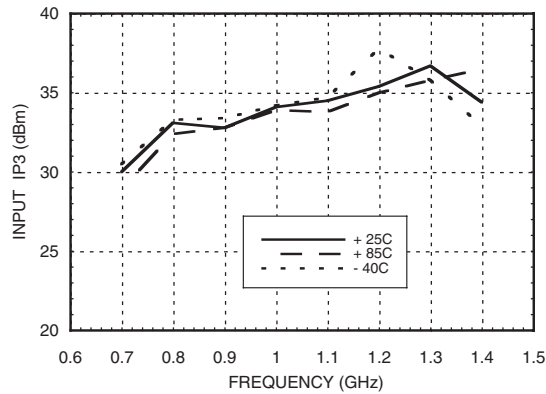

**Input IP3 vs. LO Drive**

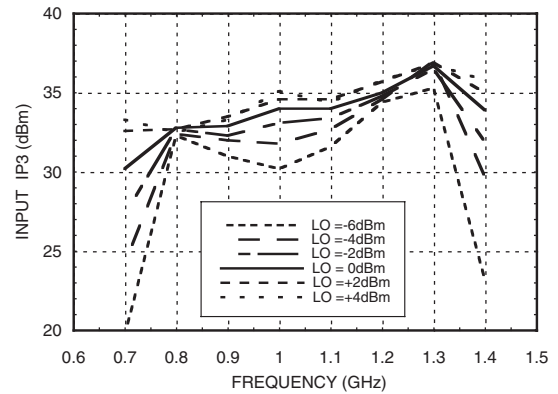

**Input IP2 vs. Temperature**

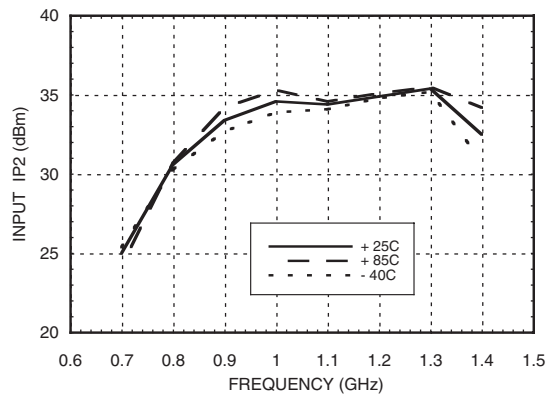

**Input IP2 vs. LO Drive**

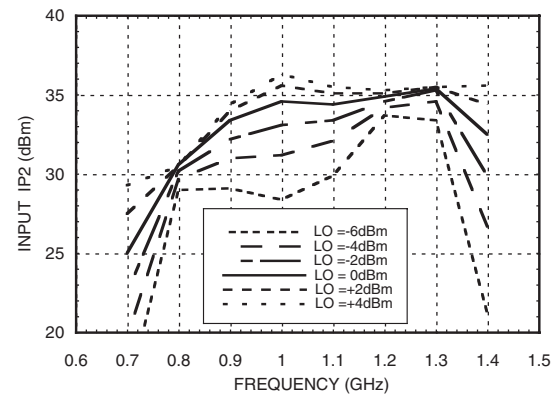

**Input P1dB vs. Temperature**

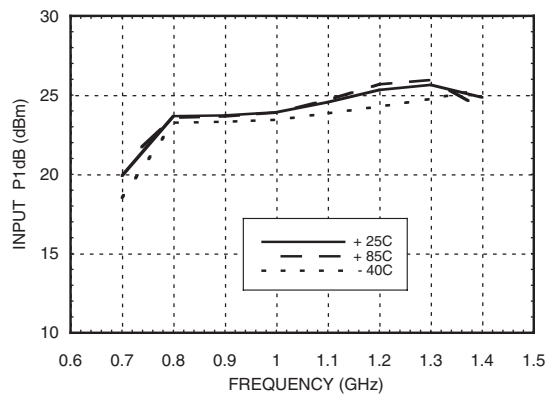

**Upconverter IP3 vs. LO Drive**

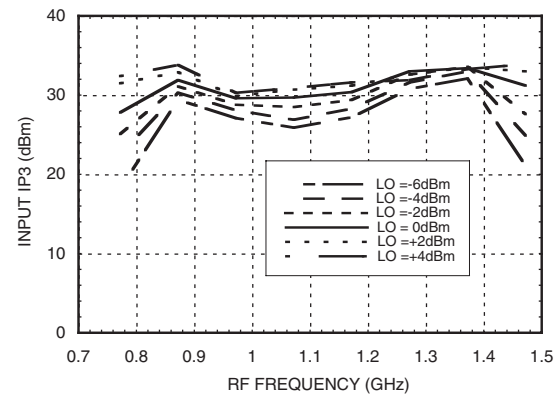



MICROWAVE CORPORATION v00.0805



# HMC483MS8G / 483MS8GE

## HIGH IP3 GaAs MMIC MIXER with INTEGRATED LO AMPLIFIER, 0.7 - 1.4 GHz

### MxN Spurious Outputs

mRF	nLO				
	0	1	2	3	4
0	xx	-9	24	3	16
1	4	0	30	15	28
2	66	71	50	61	61
3	83	95	103	89	95
4	106	105	103	108	108

RF Freq = 0.87 GHz @ -10 dBm  
 LO Freq = 0.8 GHz @ 0 dBm  
 All values in dBc Relative to the IF power level.

### Harmonics of LO

LO Freq GHz	nLO Spur at RF Port			
	1	2	3	4
0.7	21	23	24	25
0.8	15	23	18	43
0.9	12	26	23	39
1	9	22	33	32
1.1	6	22	42	27
1.2	3	21	25	26

LO power = 0 dBm  
 All values in dBc below input LO level measured at RF port.



MICROWAVE CORPORATION v00.0805



# HMC483MS8G / 483MS8GE

**HIGH IP3 GaAs MMIC MIXER with  
INTEGRATED LO AMPLIFIER, 0.7 - 1.4 GHz**

## Absolute Maximum Ratings

RF/IF Input	+27 dBm
LO Drive	+10 dBm
Bias Supply (Vdd)	+7 Vdc
Channel Temperature	150 °C
Continuous P <sub>diss</sub> (T = 85°C) (Derate 8.95 mW/°C above 85°C)	0.58 W
Thermal Resistance (R <sub>TH</sub> ) (Channel to ground paddle)	111.7 °C/W
Storage Temperature	-65 to +150 °C
Operating Temperature	-40 to +85 °C
IF DC Current	±40 mA
ESD Sensitivity (HBM)	Class 1B



**ELECTROSTATIC SENSITIVE DEVICE  
OBSERVE HANDLING PRECAUTIONS**

## Outline Drawing

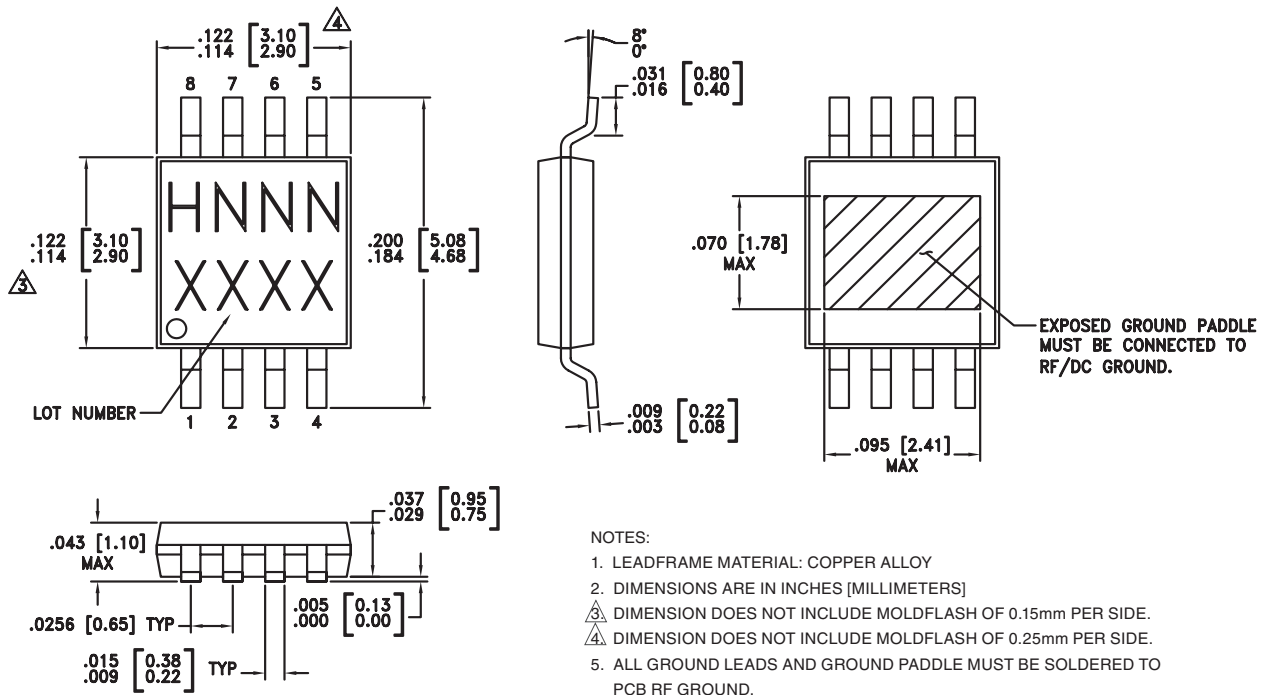

## Package Information

Part Number	Package Body Material	Lead Finish	MSL Rating	Package Marking <sup>[3]</sup>
HMC483MS8G	Low Stress Injection Molded Plastic	Sn/Pb Solder	MSL1 <sup>[1]</sup>	H483 XXXX
HMC483MS8GE	RoHS-compliant Low Stress Injection Molded Plastic	100% matte Sn	MSL1 <sup>[2]</sup>	H483 XXXX



[1] Max peak reflow temperature of 235 °C

[2] Max peak reflow temperature of 260 °C

[3] 4-Digit lot number XXXX

For price, delivery, and to place orders, please contact Hittite Microwave Corporation:  
 20 Alpha Road, Chelmsford, MA 01824 Phone: 978-250-3343 Fax: 978-250-3373  
 Order On-line at [www.hittite.com](http://www.hittite.com)

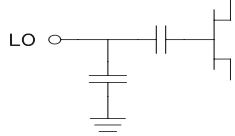
**Pin Descriptions**

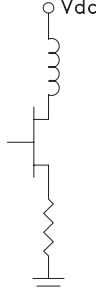
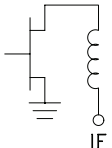
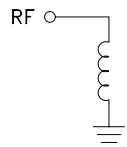
Pin Number	Function	Description	Interface Schematic
1	LO	This pin is AC coupled & matched to 50 Ohms from 0.7 to 1.4 GHz.	
2	N/C	Not connected. This pin may be connected to RF/DC ground without affecting performance.	
3, 6, 7	GND	This pin and the ground paddle must be connected to RF ground.	
4	Vdd	Power supply for LO amplifier. An external RF bypass capacitor is required.	
5	IF	This pin is DC coupled. For applications not requiring operation to DC this port should be DC blocked externally using a series capacitor. Choose value of capacitor to pass IF frequency desired. For operation to DC, this pin must not sink/source more than 40 mA of current or failure may result.	
8	RF	This pin is DC coupled & matched to 50 Ohms from 0.7 to 1.4 GHz	

### Evaluation PCB

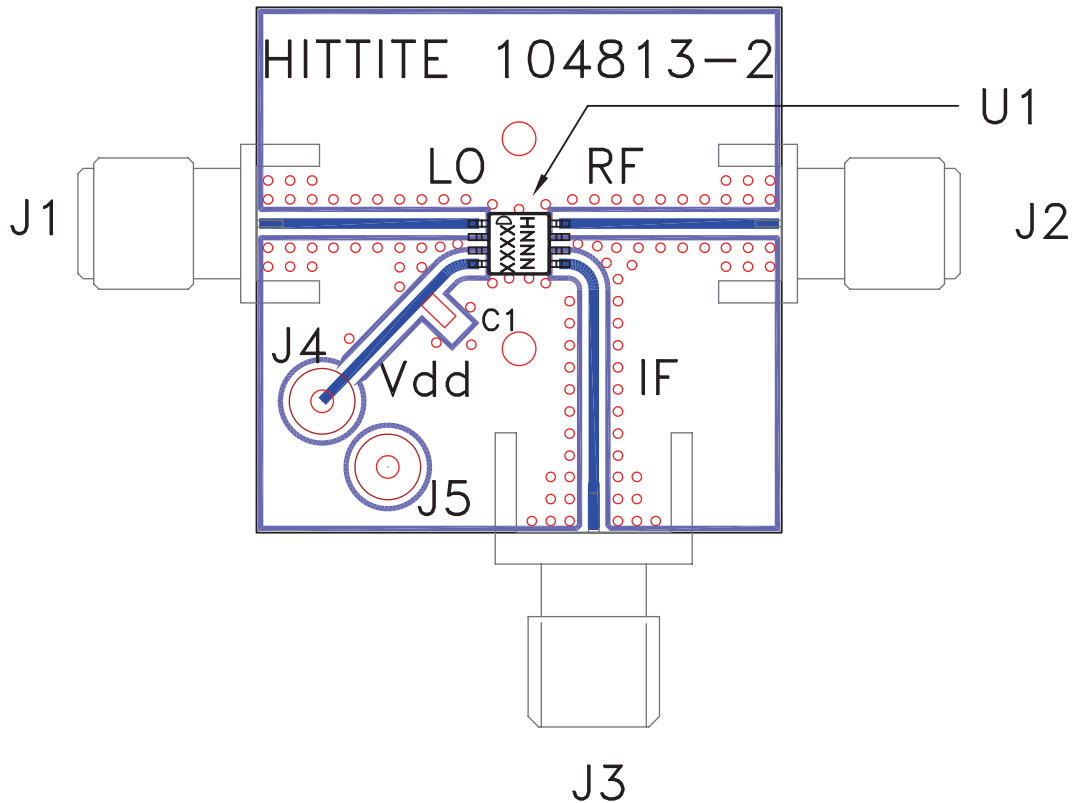

### List of Materials for Evaluation PCB 105188 [1]

Item	Description
J1 - J3	PCB Mount SMA RF Connector
J4 - J5	DC Pin
C1	10,000 pF Chip Capacitor, 0603 Pkg.
U1	HMC483MS8G / HMC483MS8GE Mixer
PCB [2]	104813 Evaluation Board

[1] Reference this number when ordering complete evaluation PCB

[2] Circuit Board Material: Rogers 4350

The circuit board used in the final application should use RF circuit design techniques. Signal lines should have 50 ohm impedance while the package ground leads and exposed paddle should be connected directly to the ground plane similar to that shown. A sufficient number of VIA holes should be used to connect the top and bottom ground planes. The evaluation circuit board shown is available from Hittite upon request.



MICROWAVE CORPORATION v00.0805



## HMC483MS8G / 483MS8GE

*HIGH IP3 GaAs MMIC MIXER with  
INTEGRATED LO AMPLIFIER, 0.7 - 1.4 GHz*

**Notes:**