

**NEW PRODUCT**

**Features**

- Low Forward Voltage Drop
- Fast Switching
- Ultra-Small Surface Mount Package
- PN Junction Guard Ring for Transient and ESD Protection
- **Lead Free/RoHS Compliant (Note 3)**

**Mechanical Data**

- Case: SOT-363
- Case Material: Molded Plastic. UL Flammability Classification Rating 94V-0
- Moisture Sensitivity: Level 1 per J-STD-020C
- Terminals: Solderable per MIL-STD-202, Method 208
- Lead Free Plating (Matte Tin Finish annealed over Alloy 42 leadframe). Please See Ordering Information, Note 5, on Page 2
- Orientation: See Diagrams Below
- Weight: 0.006 grams (approx.)
- Marking: See Diagrams Below & Page 2

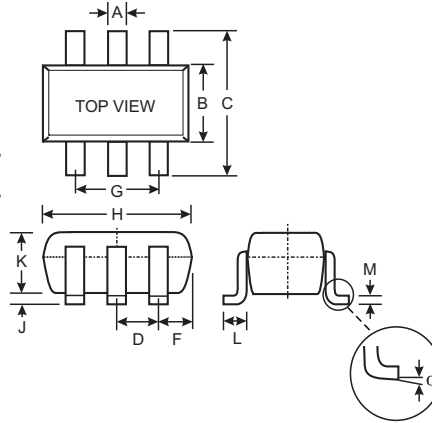

SOT-363		
Dim	Min	Max
A	0.10	0.30
B	1.15	1.35
C	2.00	2.20
D	0.65 Nominal	
F	0.30	0.40
H	1.80	2.20
J	—	0.10
K	0.90	1.00
L	0.25	0.40
M	0.10	0.25
$\alpha$	0°	8°

**All Dimensions in mm**

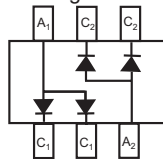

BAT54ADW\*  
Marking: KL6

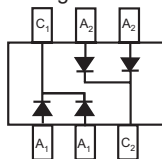

BAT54CDW\*  
Marking: KL7

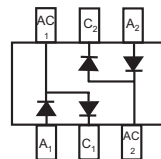

BAT54SDW\*  
Marking: KL8

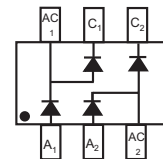

BAT54BRW  
Marking: KLB

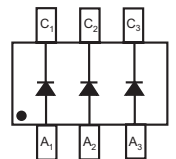

BAT54TW  
Marking: KLA

\*Symmetrical configuration, no orientation indicator.

**Maximum Ratings @ T<sub>A</sub> = 25°C unless otherwise specified**

Characteristic	Symbol	Value	Unit
Peak Repetitive Reverse Voltage	V <sub>RRM</sub>	30	V
Working Peak Reverse Voltage	V <sub>RWM</sub>		
DC Blocking Voltage	V <sub>R</sub>		
Forward Continuous Current (Note 1)	I <sub>F</sub>	200	mA
Repetitive Peak Forward Current (Note 1)	I <sub>FRM</sub>	300	mA
Forward Surge Current (Note 1)	I <sub>FSM</sub>	600	mA
Power Dissipation (Note 1)	P <sub>d</sub>	200	mW
Thermal Resistance, Junction to Ambient Air (Note 1)	R <sub>θJA</sub>	625	°C/W
Operating and Storage Temperature Range	T <sub>j</sub> , T <sub>STG</sub>	-65 to +125	°C

**Electrical Characteristics @ T<sub>A</sub> = 25°C unless otherwise specified**

Characteristic	Symbol	Min	Typ	Max	Unit	Test Condition
Reverse Breakdown Voltage (Note 2)	V <sub>(BR)R</sub>	30	—	—	V	I <sub>R</sub> = 100μA
Forward Voltage (Note 2)	V <sub>F</sub>	—	—	240 320 400 500 1000	mV	I <sub>F</sub> = 0.1mA I <sub>F</sub> = 1mA I <sub>F</sub> = 10mA I <sub>F</sub> = 30mA I <sub>F</sub> = 100mA
Reverse Leakage Current (Note 2)	I <sub>R</sub>	—	—	2.0	μA	V <sub>R</sub> = 25V
Total Capacitance	C <sub>T</sub>	—	—	10	pF	V <sub>R</sub> = 1.0V, f = 1.0MHz
Reverse Recovery Time	t <sub>rr</sub>	—	—	5.0	ns	I <sub>F</sub> = 10mA through I <sub>R</sub> = 10mA to I <sub>R</sub> = 1.0mA, R <sub>L</sub> = 100Ω

Notes: 1. Device mounted on FR-4 PCB, 1 inch x 0.85 inch x 0.062 inch; pad layout as shown on Diodes Inc. suggested pad layout document AP02001, which can be found on our website at <http://www.diodes.com/datasheets/ap02001.pdf>.

2. Short duration test pulse used to minimize self-heating effect.
3. No purposefully added lead.

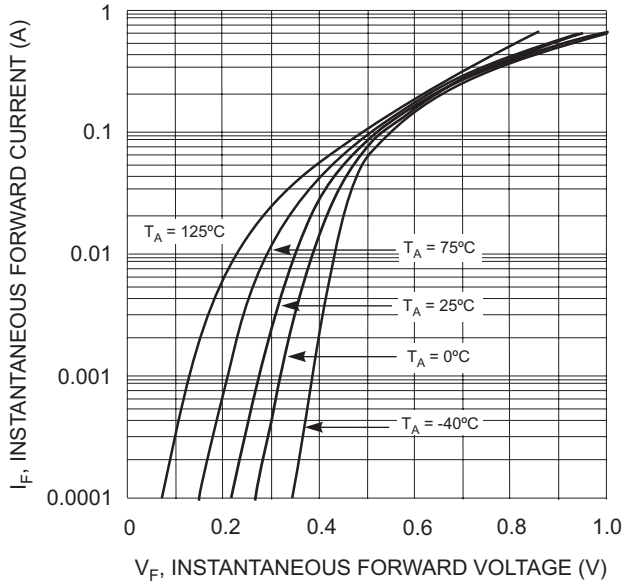

Fig. 1 Forward Characteristics

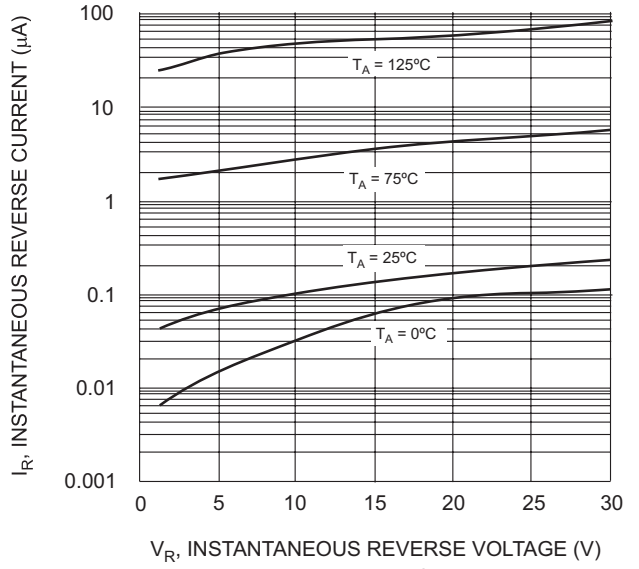

Fig. 2 Typical Reverse Characteristics

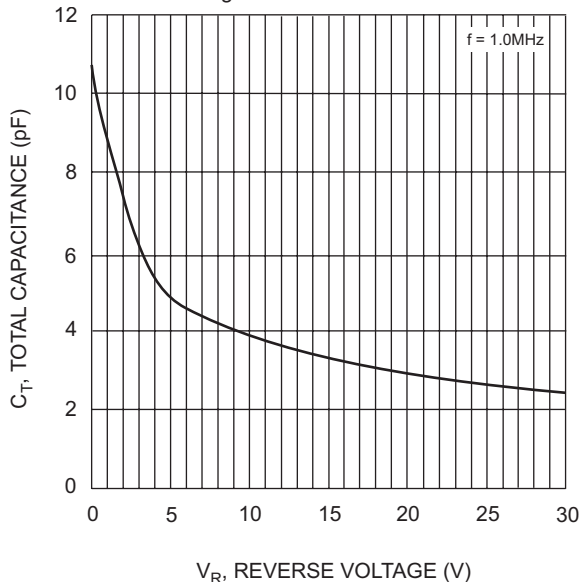

Fig. 3 Typical Capacitance vs. Reverse Voltage

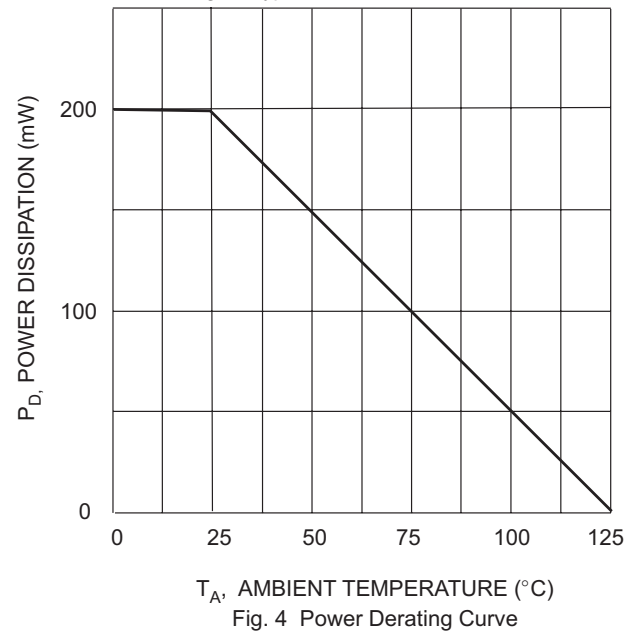

Fig. 4 Power Derating Curve

**Ordering Information** (Note 4 and 5)

Device	Packaging	Shipping
BAT54ADW-7-F BAT54CDW-7-F BAT54SDW-7-F BAT54BRW-7-F BAT54TW-7-F	SOT-363	3000/Tape & Reel

Notes: 4. For Packaging Details, go to our website at <http://www.diodes.com/datasheets/ap02007.pdf>.

**Marking Information**

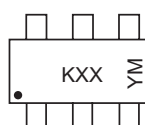

KXX = Product Type Marking Code (See Page 1)  
YM = Date Code Marking  
Y = Year ex: N = 2002  
M = Month ex: 9 = September

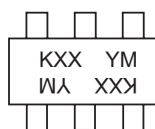

KXX = Product Type Marking Code (See Page 1)  
For Symmetrical Configuration, No Orientation Indicator  
YM = Date Code Marking  
Y = Year ex: N = 2002  
M = Month ex: 9 = September

Date Code Key

Year	2001	2002	2003	2004	2005	2006	2007	2008	2009
Code	M	N	P	R	S	T	U	V	W

Month	Jan	Feb	March	Apr	May	Jun	Jul	Aug	Sep	Oct	Nov	Dec
Code	1	2	3	4	5	6	7	8	9	O	N	D

**IMPORTANT NOTICE**

Diodes, Inc. and its subsidiaries reserve the right to make changes without further notice to any product herein to make corrections, modifications, enhancements, improvements, or other changes. Diodes, Inc. does not assume any liability arising out of the application or use of any product described herein; neither does it convey any license under its patent rights, nor the rights of others. The user of products in such applications shall assume all risks of such use and will agree to hold Diodes Incorporated and all the companies whose products are represented on our website, harmless against all damages.

**LIFE SUPPORT**

The products located on our website at [www.diodes.com](http://www.diodes.com) are not recommended for use in life support systems where a failure or malfunction of the component may directly threaten life or cause injury without the express written approval of Diodes Incorporated.