

**PLEASE CHECK WWW.MOLEX.COM FOR LATEST PART INFORMATION**

**Part Number:** [0351500600](#)  
**Status:** **Active**  
**Overview:** [versablade](#)  
**Description:** 7.30mm (.287") Pitch Wire-to-Wire VersaBlade™ Hybrid Receptacle Housing, without Mounting Ears, 6 Circuits, Polyester UL94V-0, Natural

**Documents:**

[Drawing \(PDF\)](#) [RoHS Certificate of Compliance \(PDF\)](#)

**Agency Certification**

CSA	LR19980
TUV	R72090206
UL	E29179

**General**

Product Family	Crimp Housings
Series	<a href="#">35150</a>
Comments	Polarized to Mating Part, Positive Lock
Overview	<a href="#">versablade</a>
Product Name	VersaBlade™

**Physical**

Circuits (maximum)	6
Color - Resin	Natural
Flammability	94V-0
Gender	Male
Glow-Wire Compliant	No
Keying to Mating Part	None
Lock to Mating Part	Yes
Material - Resin	Polyester
Number of Rows	2
Packaging Type	Bag
Panel Mount	No
Pitch - Mating Interface (in)	0.350 In
Pitch - Mating Interface (mm)	8.90 mm
Polarized to Mating Part	Yes
Stackable	No
Temperature Range - Operating	-40°C to +120°C

**Material Info**

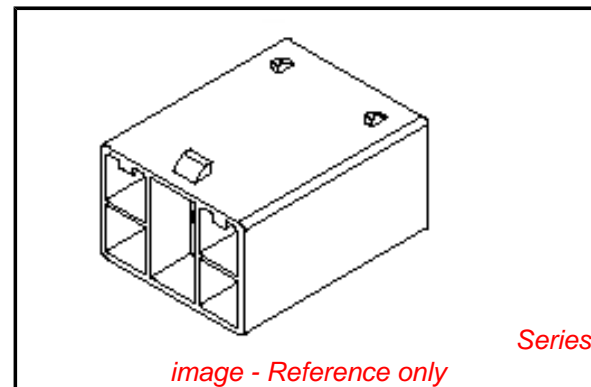

**EU RoHS**

**ELV and RoHS Compliant**  
**REACH SVHC**  
 Not Reviewed  
**Halogen-Free Status**  
**Not Reviewed**

**China RoHS**



**Need more information on product environmental compliance?**

Email [productcompliance@molex.com](mailto:productcompliance@molex.com)  
 For a multiple part number RoHS Certificate of Compliance, [click here](#)

Please visit the [Contact Us](#) section for any non-product compliance questions.

**Search Parts in this Series**

[35150Series](#)

**Mates With**

[35151-061\\*](#) Plug Housings

**Use With**

VersaBlade™ Crimp Terminals, [35745](#) , [35746](#) , [35747](#)

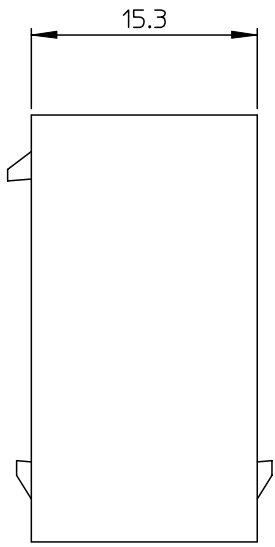
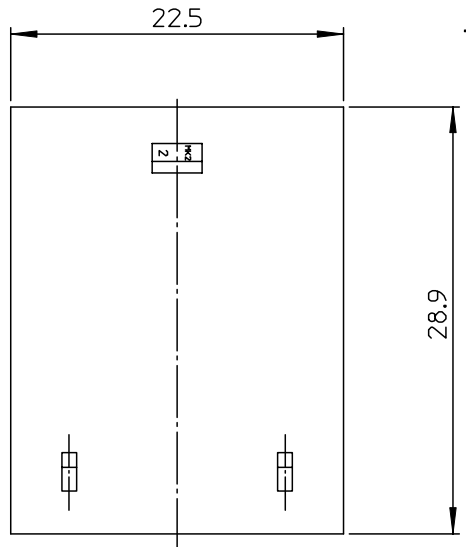
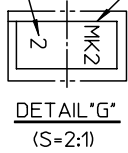
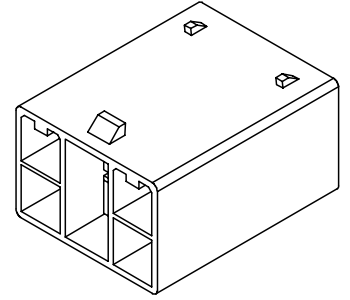
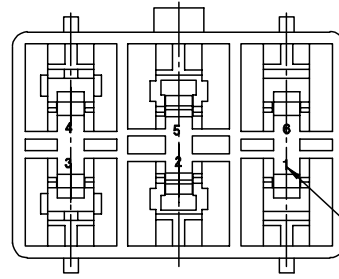
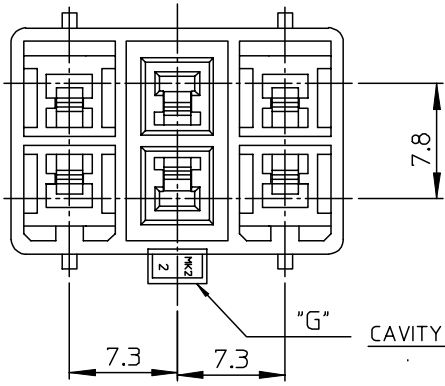

MATERIAL	MATERIAL NO.	ENG NO.	COLOR
POLYESTER(P.B.T) (UL94V-0)	351500600	35150-0600	NATURAL
	351500604	35150-0604	BLUE
PBT/PC (UL94V-0)	351500609	35150-0609	NATURAL
	351503609	35150-3609	YELLOW

NOTES

- MATED HOUSING : 35151-061\*
- APPLICABLE TERMINAL : 35745-0\*10 (3,4 CIRCUIT)  
35746-0\*10 (2,5 CIRCUIT)  
35747-0\*10 (1,6 CIRCUIT)



REVISED EC NO: KOR2008-0008 DRWN: JHPARK01 2007/09/10 CHKD: W. YANG 2007/09/10 APPR: YUNSIKKIM 2007/09/10	QUALITY SYMBOLS	GENERAL TOLERANCES (UNLESS SPECIFIED)	DIMENSION STYLE MM ONLY	SCALE 2:1	DESIGN UNITS METRIC	THIRD ANGLE PROJECTION																																			
	$\nabla=0$ $\sphericalangle=0$	<table border="1"> <thead> <tr> <th></th> <th>mm</th> <th>INCH</th> </tr> </thead> <tbody> <tr> <td>4 PLACES</td> <td>± ---</td> <td>± ---</td> </tr> <tr> <td>3 PLACES</td> <td>± ---</td> <td>± ---</td> </tr> <tr> <td>2 PLACES</td> <td>± 0.3</td> <td>± ---</td> </tr> <tr> <td>1 PLACE</td> <td>± 0.3</td> <td>± ---</td> </tr> </tbody> </table>		mm	INCH	4 PLACES	± ---	± ---	3 PLACES	± ---	± ---	2 PLACES	± 0.3	± ---	1 PLACE	± 0.3	± ---	<table border="1"> <thead> <tr> <th>DRAWN BY</th> <th>DATE</th> <th>TITLE</th> </tr> </thead> <tbody> <tr> <td>BK. CHOI</td> <td>1993/05/19</td> <td rowspan="2">7.3 PITCH W/W CONN. MALE HSG-6P(W/O EAR)</td> </tr> <tr> <td>CHECKED BY</td> <td>DATE</td> </tr> <tr> <td>BK. CHOI</td> <td>1993/05/19</td> <td rowspan="2">MOLEX INCORPORATED</td> </tr> <tr> <td>APPROVED BY</td> <td>DATE</td> </tr> <tr> <td>CW. LEE</td> <td>1993/05/19</td> <td></td> </tr> </tbody> </table>	DRAWN BY	DATE	TITLE	BK. CHOI	1993/05/19	7.3 PITCH W/W CONN. MALE HSG-6P(W/O EAR)	CHECKED BY	DATE	BK. CHOI	1993/05/19	MOLEX INCORPORATED	APPROVED BY	DATE	CW. LEE	1993/05/19		<table border="1"> <thead> <tr> <th>MATERIAL NO.</th> <th>DOCUMENT NO.</th> <th>SHEET NO.</th> </tr> </thead> <tbody> <tr> <td>SEE TABLE</td> <td>SD-35150-060</td> <td>1 OF 01</td> </tr> </tbody> </table>	MATERIAL NO.	DOCUMENT NO.	SHEET NO.	SEE TABLE	SD-35150-060	1 OF 01
		mm	INCH																																						
	4 PLACES	± ---	± ---																																						
3 PLACES	± ---	± ---																																							
2 PLACES	± 0.3	± ---																																							
1 PLACE	± 0.3	± ---																																							
DRAWN BY	DATE	TITLE																																							
BK. CHOI	1993/05/19	7.3 PITCH W/W CONN. MALE HSG-6P(W/O EAR)																																							
CHECKED BY	DATE																																								
BK. CHOI	1993/05/19	MOLEX INCORPORATED																																							
APPROVED BY	DATE																																								
CW. LEE	1993/05/19																																								
MATERIAL NO.	DOCUMENT NO.	SHEET NO.																																							
SEE TABLE	SD-35150-060	1 OF 01																																							
DRAFT WHERE APPLICABLE MUST REMAIN WITHIN DIMENSIONS	SIZE A3	THIS DRAWING CONTAINS INFORMATION THAT IS PROPRIETARY TO MOLEX INCORPORATED AND SHOULD NOT BE USED WITHOUT WRITTEN PERMISSION																																							