

GENERAL DESCRIPTION

The XRP2527 and XRP2528 devices are respectively single and dual channel integrated high-side power distribution switches with independent enables, fault flags and precise programmable current limit thresholds. A wide 1.8V to 5.5V input voltage range allows for operations from industry standard 1.8V, 3.3V and 5V power rails.

Current limit thresholds can be programmed accurately and independently for each channel via an external resistor. A simple setting optimizes the XRP2527 and XRP2528 for use in USB 2.0 or 3.0 compliant V_{BUS} power distribution architectures. These devices can be used in any self or bus powered USB applications. The power-switch rise and fall times are controlled to minimize current surges during turn on/off.

Built-in over current, under voltage lockout (UVLO), reverse current and over temperature protections insure safe operations under abnormal operating conditions.

XRP2527 and XRP2528 are offered respectively in RoHS compliant "green"/halogen free 3mm x 3mm 8-pin and 10-pin TDFN packages.

APPLICATIONS

- Generic Power Switching
- Self Powered USB 2.0 and 3.0 Hubs
- USB Compliant V_{BUS} Power Distribution
- Audio-Video Equipments

FEATURES

- **Single/Dual Channel Current Switch**
 - 1A per channel capable
 - 1.8V to 5.5V Input Voltage Range
- **Programmable Over-Current Limit**
 - 300mA to 1A set via external resistor
 - $\pm 8\%$ threshold accuracy at 1A
- **USB 2.0/3.0 Compliant**
- **Individual Channel Enable**
- **Individual Channel Fault Flag Indicator**
- **Under voltage Lockout, Reverse Current and Thermal Shutdown Protection**
- **RoHS Compliant, Green/Halogen Free 8-Pin and 10-Pin TDFN Package**

TYPICAL APPLICATION DIAGRAM

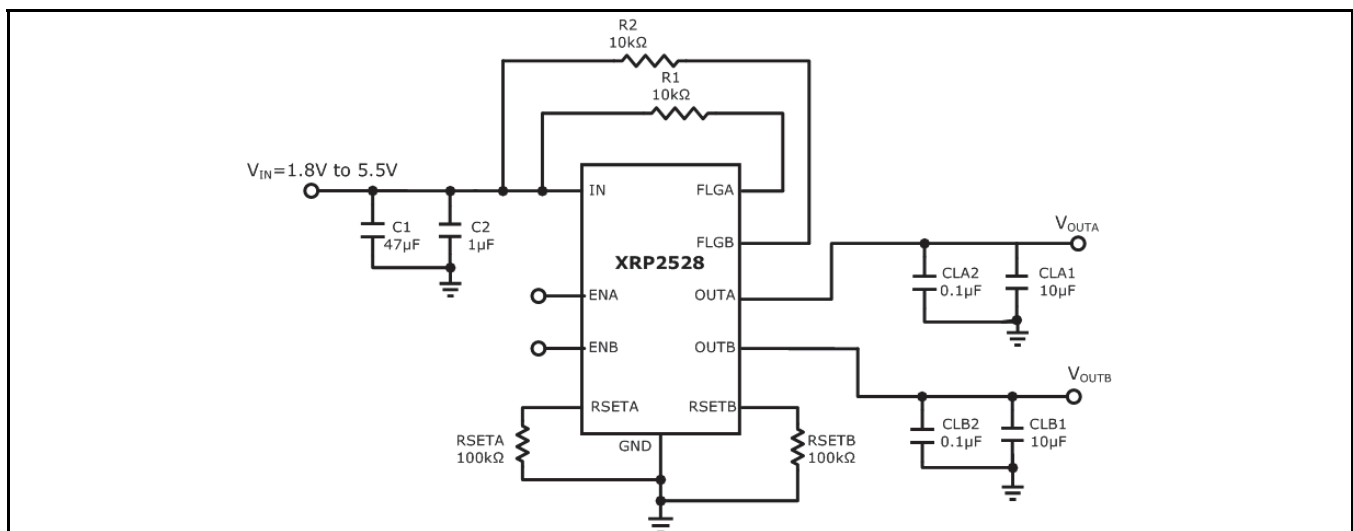

Fig. 1: XRP2528 Application Diagram



XRP2527 - XRP2528

Single/Dual Channel Adjustable Current Power Distribution Switch

ABSOLUTE MAXIMUM RATINGS

These are stress ratings only and functional operation of the device at these ratings or any other above those indicated in the operation sections of the specifications below is not implied. Exposure to absolute maximum rating conditions for extended periods of time may affect reliability.

V_{IN} -0.3V to 7.0V
 V_{EN} , V_{FLG} 7.0V
 Storage Temperature -65°C to 150°C
 Power Dissipation Internally Limited
 Lead Temperature (Soldering, 10 sec) 300°C
 ESD Rating (HBM - Human Body Model) 2kV
 ESD Rating (MM - Machine Model) 200V

OPERATING RATINGS

Input Voltage Range V_{IN} 1.75V to 5.5V
 Junction Temperature Range -40°C to 125°C
 Thermal Resistance θ_{JA}
 TDFN-8L 43.0°C/W
 TDFN-10L 40.5°C/W

ELECTRICAL SPECIFICATIONS

Specifications are for an Operating Junction Temperature of $T_J = 25^\circ\text{C}$ only; limits applying over the full Operating Junction Temperature range are denoted by a "•". Minimum and Maximum limits are guaranteed through test, design, or statistical correlation. Typical values represent the most likely parametric norm at $T_J = 25^\circ\text{C}$, and are provided for reference purposes only. Unless otherwise indicated, $V_{IN} = 1.8\text{V}$ to 5.5V , $C_{IN} = 47\mu\text{F}/1\mu\text{F}$, $C_{OUT} = 10\mu\text{F}$, $T_J = -40^\circ\text{C}$ to 125°C .

Parameter	Min.	Typ.	Max.	Units	Conditions
Input Supply Voltage	1.8		5.5	V	•
Input Quiescent Current		80	150	μA	• XRP2528, (Both Channels enabled) $V_{IN}=5\text{V}$, $I_{OUT1} = I_{OUT2} = 0\text{mA}$
Input Quiescent Current		52	100	μA	• XRP2527 and XRP2528 (1 Channel enabled) $V_{IN}=5\text{V}$, $I_{OUT1} = 0\text{mA}$
Input Shutdown Current			3	μA	• $V_{IN}=5\text{V}$, Channel(s) disabled
Maximum Output Current per channel	1			A	• XRP2527 and XRP2528. RSET=100k Ω
Output Leakage Current			10	μA	$V_{IN}=5\text{V}$, $V_{OUT}=0\text{V}$, Each channel, Switch off
Reverse Leakage Current			10	μA	$V_{IN}=0\text{V}$, $V_{OUT}=5\text{V}$, Each channel, Switch off
Output MOSFET Resistance		80	140	m Ω	• $I_{OUT}=0.3\text{A}$, Each channel
Output turn-on delay		1000		μs	$V_{IN}=5\text{V}$, $R_L=10\Omega$, $C_{OUT}=1\mu\text{F}$, each output
Output turn-on rise time		2000	4000	μs	$V_{IN}=5\text{V}$, $R_L=10\Omega$, $C_{OUT}=1\mu\text{F}$, each output
Output turn-off delay		10	20	μs	$V_{IN}=5\text{V}$, $R_L=10\Omega$, $C_{OUT}=1\mu\text{F}$, each output
Output turn-off fall time		22	50	μs	$V_{IN}=5\text{V}$, $R_L=10\Omega$, $C_{OUT}=1\mu\text{F}$, each output
Current limit threshold	0.90	1.15	1.4	A	• $V_{IN} - V_{OUT} = 0.3\text{V}$, RSET floating, USB 3.0
	0.68	0.85	1.02	A	• $V_{IN} - V_{OUT} = 0.3\text{V}$, RSET tied to V_{IN} , USB 2.0
Current limit threshold range	0.3		1	A	
Current limit threshold accuracy	1	1.087	1.174	A	• RSET=100k Ω for $I_{LIM(min)}=1\text{A}$, $V_{IN}-V_{OUT}=0.3\text{V}$
Short Circuit Current Limit		$0.66 \times I_{LIM}$		A	$V_{OUT} = 0\text{V}$
Output Voltage Short Circuit Detect Threshold		925		mV	Device operates in short circuit current limit mode when output voltage is below the threshold.
Safe Operating Area (SOA) Current Limit		3		A	
Over temperature shutdown threshold		135		$^\circ\text{C}$	Temperature rising
Over temperature shutdown threshold hysteresis		10		$^\circ\text{C}$	Temperature decreasing
Under-voltage lockout threshold	1.55	1.68	1.75	V	V_{IN} rising or falling
Under-voltage lockout hysteresis		50		mV	
FLG output logic low voltage		100	250	mV	$I_{FLG}=10\text{mA}$, $V_{IN}=5.5\text{V}$
FLG output high leakage			1	μA	



XRP2527 - XRP2528

Single/Dual Channel Adjustable Current Power Distribution Switch

Parameter	Min.	Typ.	Max.	Units	Conditions
FLG blanking time		10		ms	
EN input logic high voltage	1.5			V	•
EN input logic low voltage			0.5	V	•
EN input leakage current	-1	0	1	μ A	$V_{EN}=0V$ or $V_{EN}=5.5V$

BLOCK DIAGRAM

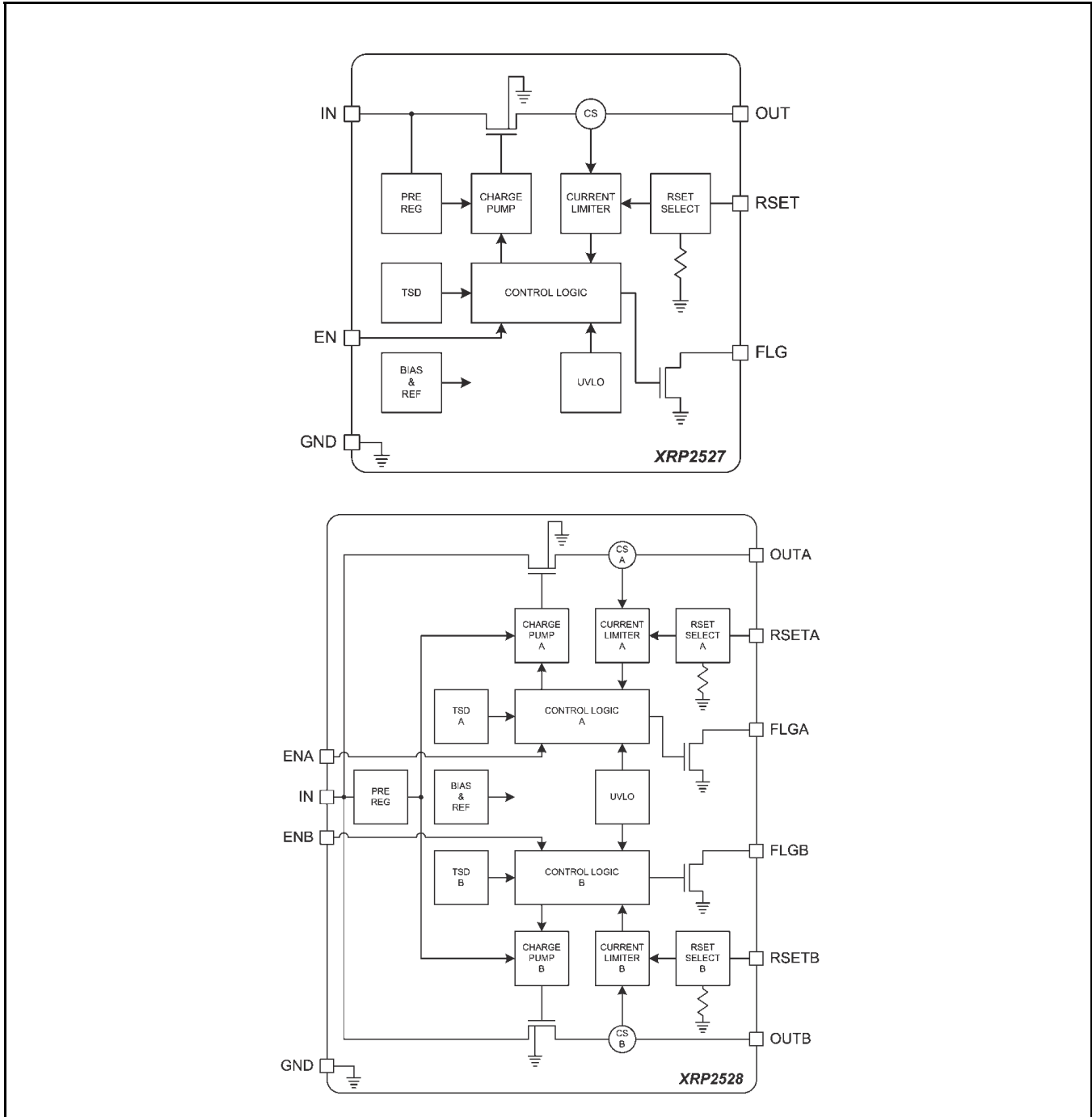

Fig. 2: XRP2527-XRP2528 Block Diagrams

PIN ASSIGNMENT

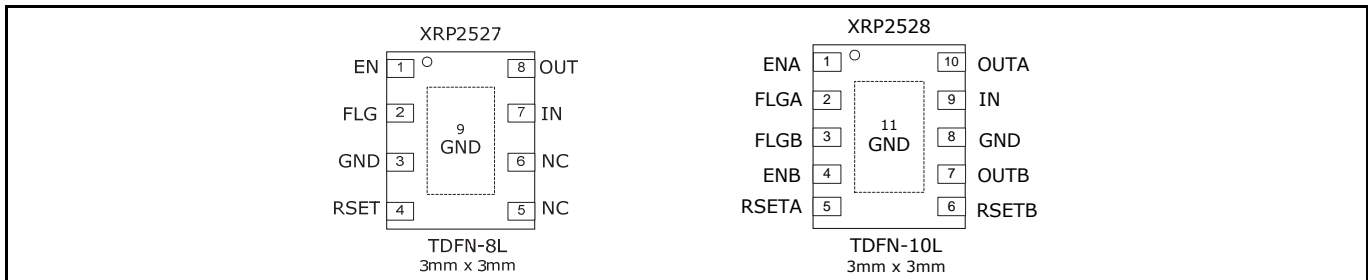

Fig. 3: XRP2527/28 Pin Assignment

PIN DESCRIPTION – XRP2527

Name	Pin Number	Description
EN	1	Channel Enable Input
FLG	2	Error Flag Signal Active low open drain output. Active on over-current, over-temperature or UVLO conditions.
GND	3	Ground Signal
NC	5,6	No Connect
IN	7	Voltage Input Pin
OUT	8	Voltage Output Pin
RSET	4	Current Limiting Threshold setting RSET floating: USB 3.0 current limit settings RSET tied to IN: USB 2.0 current limit settings RSET tied to GND via resistor R: Adjustable current limit

PIN DESCRIPTION – XRP2528

Name	Pin Number	Description
EN _x	1,4	Channel Enable Input
FLG _x	2,3	Error Flag Signal Active low open drain output. Active on over-current, over-temperature or UVLO conditions.
GND	8	Ground Signal
IN	9	Voltage Input Pin
OUT _x	7,10	Voltage Output Pin
RSET _x	5,6	Current Limiting Threshold setting RSET floating: USB 3.0 current limit settings RSET tied to IN: USB 2.0 current limit settings RSET tied to GND via resistor R: Adjustable current limit

ORDERING INFORMATION

Part Number	Temperature Range	Marking	Package	Packing Quantity	Note 1	Note 2
XRP2527IHB-1-F	-40°C ≤ T _A ≤ +85°C	2527I YYWW 1 X	TDFN8	Bulk	Lead Free and Halogen Free	Single Channel Active high
XRP2527IHBTR-1-F				2.5K/Tape & Reel		
XRP2528IHB-1-F	-40°C ≤ T _A ≤ +85°C	2528I YYWW 1 X	TDFN10	Bulk	Lead Free and Halogen Free	Dual Channel Active high
XRP2528IHBTR-1-F				2.5K/Tape & Reel		
XRP2527EVB	XRP2527 Evaluation Board					
XRP2528EVB	XRP2528 Evaluation Board					

“YY” = Year – “WW” = Work Week – “X” = Lot Number



XRP2527 - XRP2528

Single/Dual Channel Adjustable Current Power Distribution Switch

TYPICAL PERFORMANCE CHARACTERISTICS

All data taken at $V_{IN} = 5V$, $C_{IN} = 47\mu F/1\mu F$, $C_{OUT} = 10\mu F$, $T_J = T_A = 25^\circ C$, unless otherwise specified - Schematic and BOM from Application Information section of this datasheet.

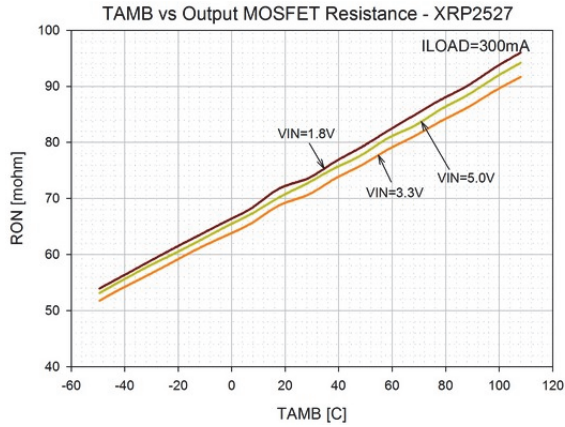

Fig. 4: Output On-Resistance vs. Temperature (XRP2527)

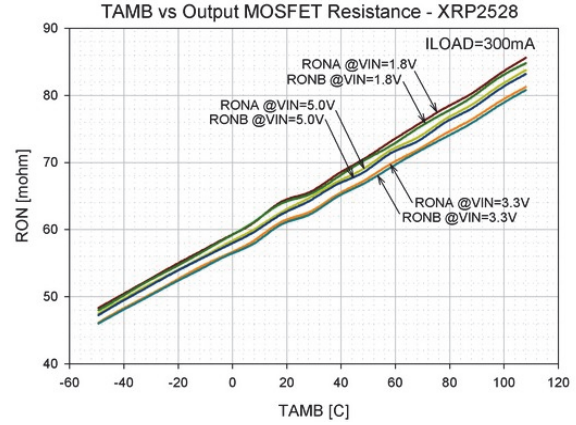

Fig. 5: Output On-Resistance vs. Temperature (XRP2528)

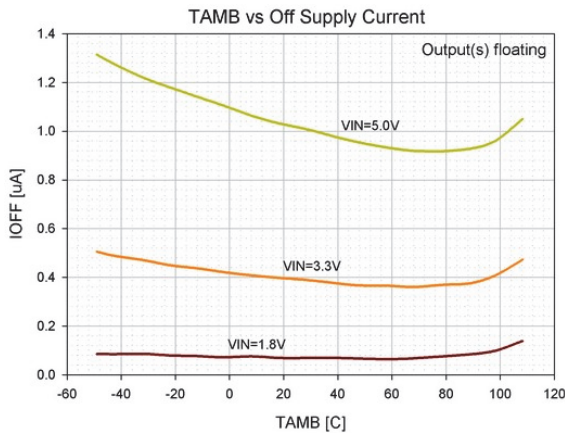

Fig. 6: Off Supply Current vs. Temperature

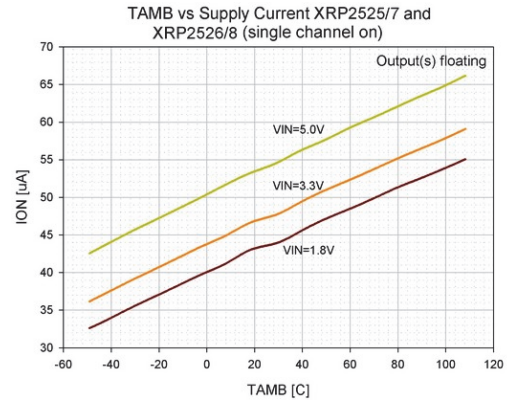

Fig. 7: Quiescent Current vs. Temperature XRP2527 and XRP2528 (1-channel on)

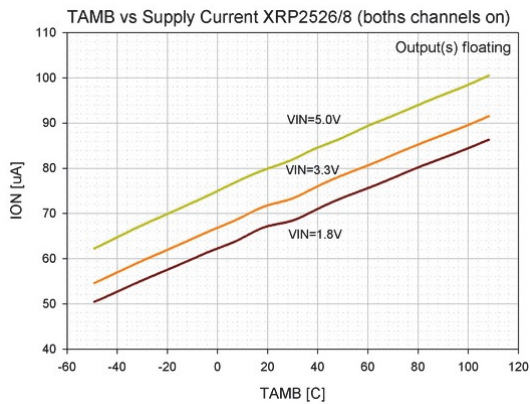

Fig. 8: Quiescent Current vs. Temperature XRP2528 (2-channels on)

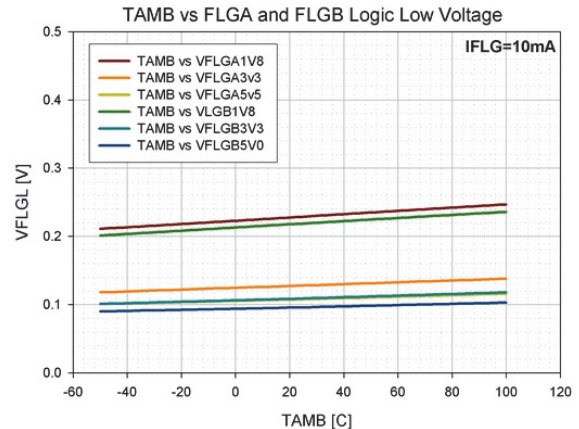

Fig. 9: FLG Logic Low Voltage vs. Temperature



XRP2527 - XRP2528

Single/Dual Channel Adjustable Current Power Distribution Switch

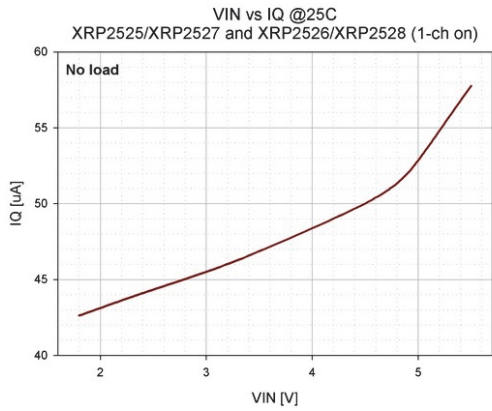

Fig. 10: Quiescent Current vs. Input Voltage XRP2527 and XRP2528 (1-channel on)

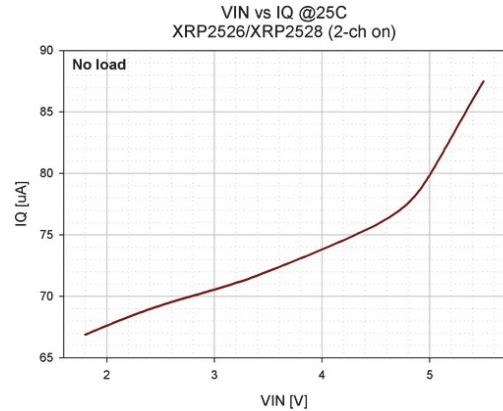

Fig. 11: Quiescent Current vs. Input Voltage XRP2528 (2-channels on)

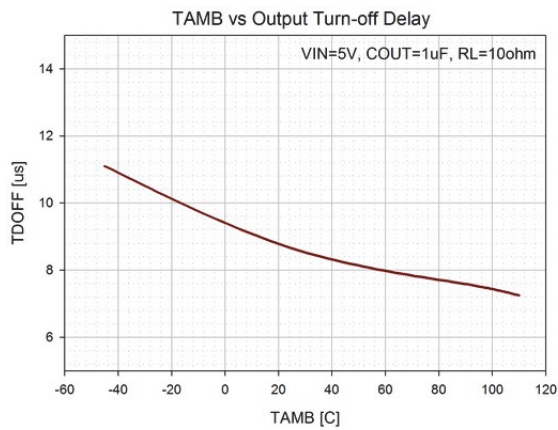

Fig. 12: Output Turn-Off Delay vs. Temperature

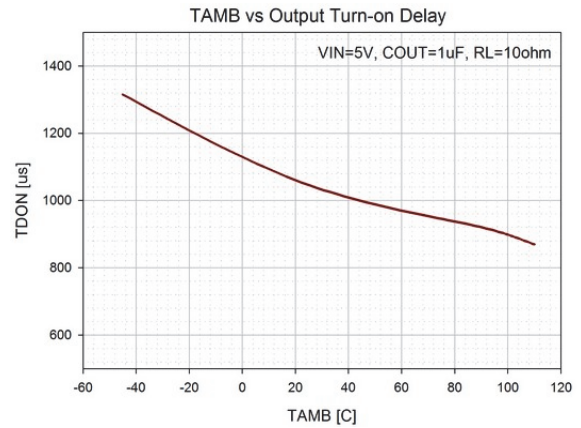

Fig. 13: Output Turn-on Delay vs. Temperature

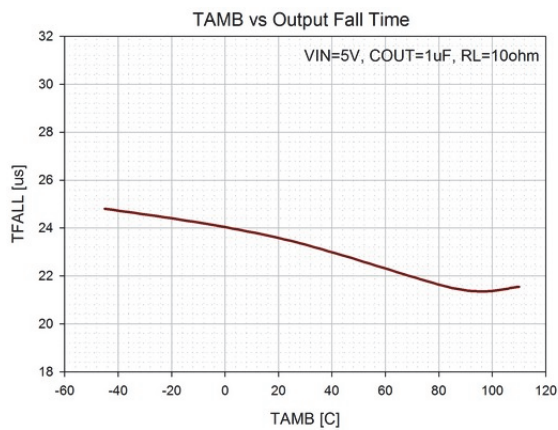

Fig. 14: Output Fall Time vs. Temperature

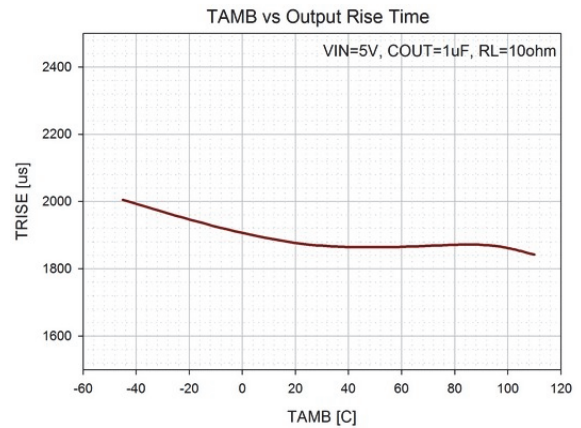

Fig. 15: Output Rise Time vs. Temperature



XRP2527 - XRP2528

Single/Dual Channel Adjustable Current Power Distribution Switch

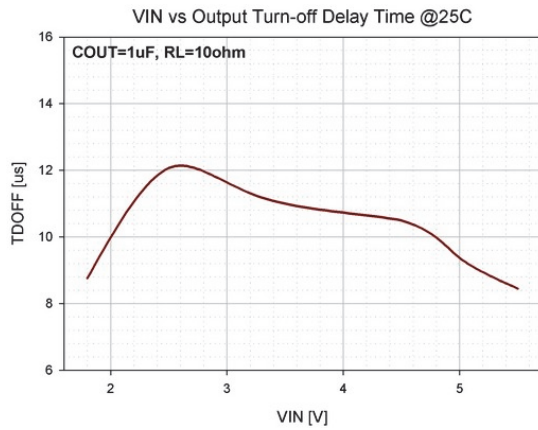

Fig. 16: Output Turn-Off Delay Time vs. Input Voltage

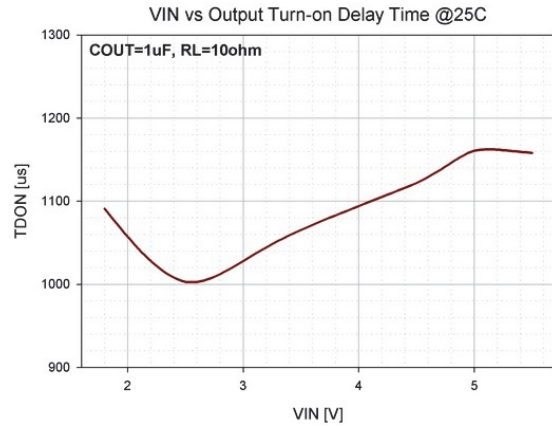

Fig. 17: Output Turn-On Delay Time vs. Input Voltage

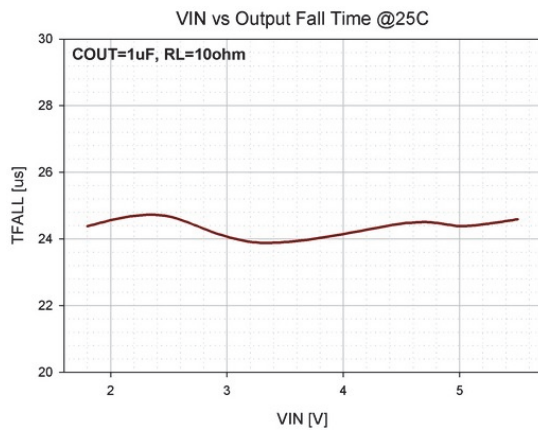

Fig. 18: Output Fall Time vs. Input Voltage

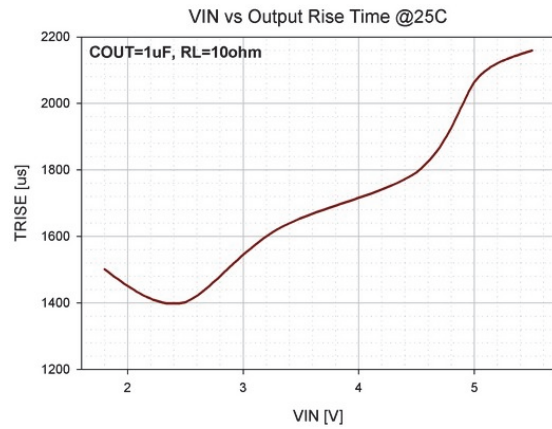

Fig. 19: Output Rise Time vs. Input Voltage

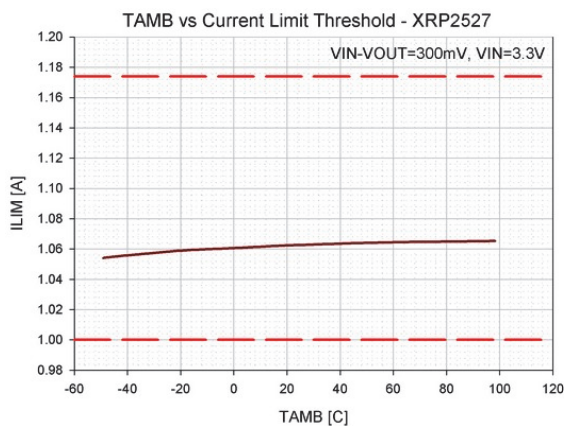

Fig. 20: Current Limit Threshold vs. Temperature (XRP2527)

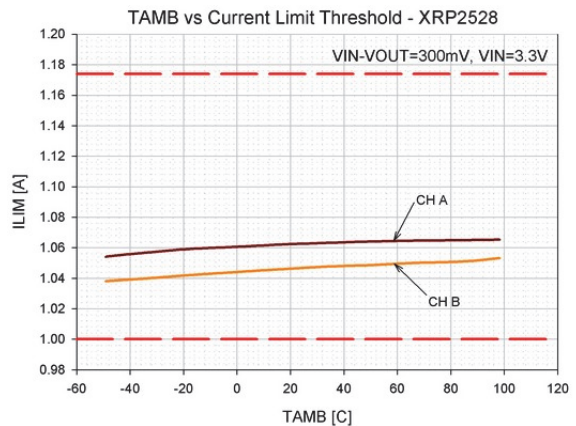

Fig. 21: Current Limit Threshold vs. Temperature (XRP2528)

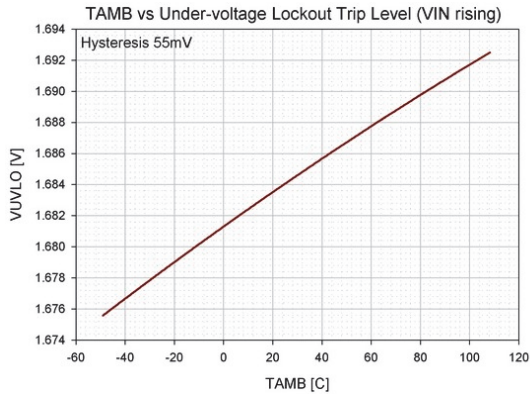

Fig. 22: Under-voltage lockout trip level vs. Temperature (VIN Rising)

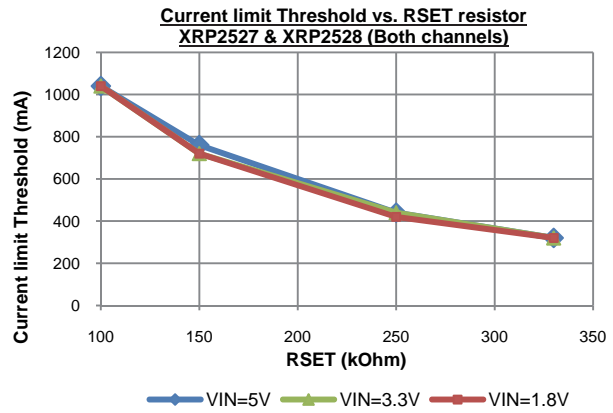

Fig. 23: Current Limit Threshold vs. RSET resistor value

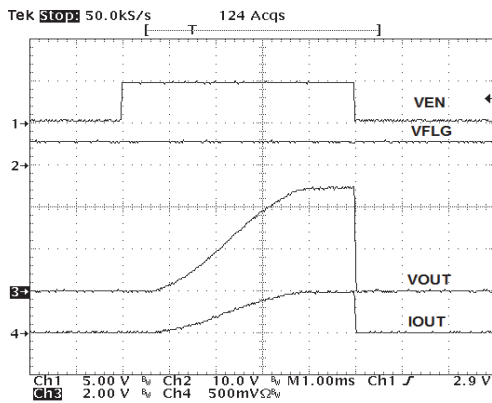

Fig. 24: Turn-On, Turn-Off Characteristics (XRP2528):
COUT = 1uF, Rload = 10Ω, RSET floating

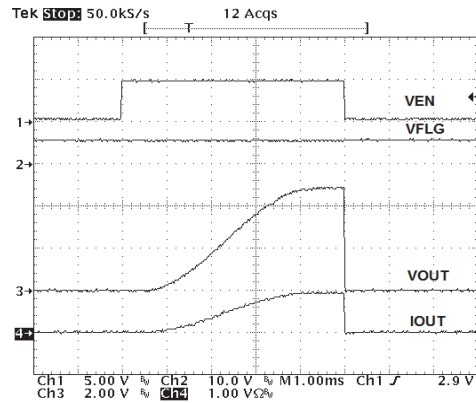

Fig. 25: Turn-On, Turn-Off Characteristics (XRP2528):
COUT = 1uF, Rload = 5Ω, RSET floating

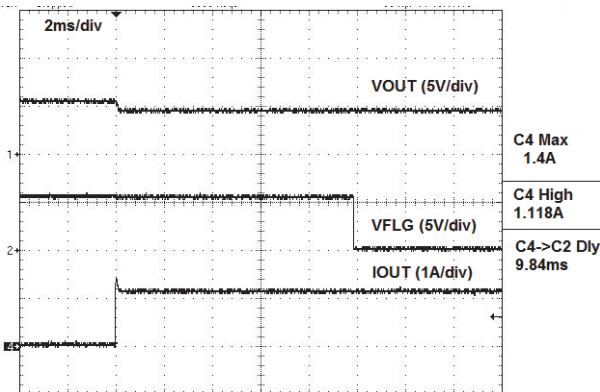

Fig. 26: Current Limit Operation (XRP2527):
VIN=5.5V, Rload = 3.9Ω, USB3.0

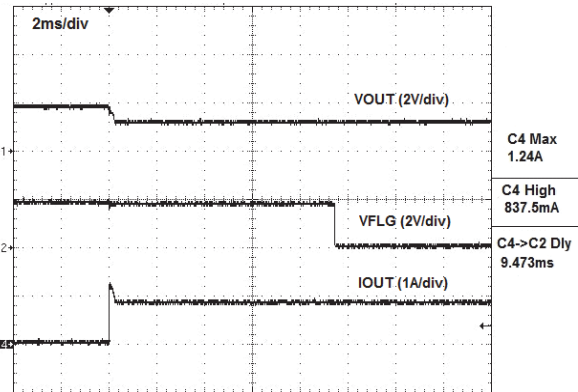

Fig. 27: Current Limit Operation (XRP2528):
VIN=1.8V, Rload = 1.5Ω, USB2.0

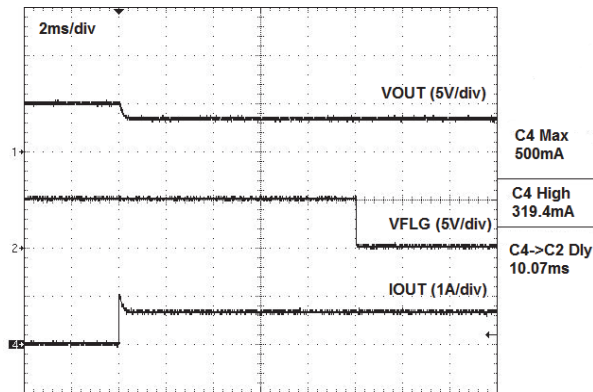

Fig. 28: Current Limit Operation (XRP2527):
VIN=5V, Rload = 10Ω, RSET = 330kΩ

THEORY OF OPERATION

The XRP2527 and XRP2528 devices are respectively single and dual channel integrated high-side power distribution switches with programmable current limit threshold feature. They can be used in any self or bus powered USB applications and are compliant with the latest USB 3.0 specifications. The reverse current protection feature prevents current to flow from OUT to IN when the device is disabled.

INPUT & OUTPUT

Placing bulk capacitances of at least 47μF and 10μF at the input and output pins respectively reduces power supply transients under heavy current load conditions.

It is important to place a 1μF ceramic bypass capacitor from IN to GND as close as possible to the device in order to control supply transients.

Furthermore, bypassing the output pin with a 0.1μF to 1μF ceramic capacitor improves the device response to short-circuit transients.

ERROR FLAG

The error flag signal (FLG_x output pin) is an open-drain output and is pulled low (active low) upon detection of the following conditions:

- Over-current condition
- Over-temperature condition
- Under voltage lockout condition

Over-temperature and under voltage lockout conditions are flagged immediately while the output over – current condition is reported if continuously persistent for longer than the blanking time of 10ms. The blanking time prevents erroneous reporting of current faults due to brief output current spikes.

Once activated, the error flag signal remains low until all fault conditions have been removed and is independent for each individual channel.

CURRENT LIMIT

The current limit feature protects the output MOSFET switches from damages resulting from undesirable short circuit conditions or excess inrush current, which is often encountered during hot plug-in. Upon detection of overcurrent condition, the output current is limited to a constant current limit threshold value and the output voltage is reduced accordingly. Triggering the current limit function is signaled by the Error Flag after 10ms of blanking time period.

The minimum current limit threshold can be programmed from 300mA to 1A set via an external resistor at the RSET pin. If RSET pin is left floating, then the device is set to USB 3.0 current limit setting. For USB 2.0 current limit setting, the RSET pin must be tied to VIN. The current limit threshold value is set using the resistor at RSET pin by the following equation:



XRP2527 - XRP2528 Single/Dual Channel Adjustable Current Power Distribution Switch

$$I_{LIM} \text{ typ. [A]} = \frac{108.7}{R_{SET}[\text{kohm}]}$$

Please note that the allowed values for RSET resistor are $100\text{kohm} < R_{SET} < 330\text{kohm}$.

UNDER-VOLTAGE LOCKOUT

Under-voltage lockout function (UVLO) keeps the internal power switch from being turned on until the power supply has reached at least 1.68V, even if the switch is enabled. Upon detection of an input voltage below approximately 1.68V, the power switch is turned off while a fault condition is reported by the error flag signal.

THERMAL PROTECTION

Internal thermal sensing circuitry monitors the operating temperature of the device for each channel independently. Upon detection of a temperature in excess of 135°C, the power switch for the given channel is disabled

preventing any damages to the device while a fault condition is reported by the error flag signal. A built-in 10°C hysteresis allows the device to cool down to 125°C before resuming normal operations on the faulty channel at which point the error flag signal is cleared.

TEST CIRCUIT

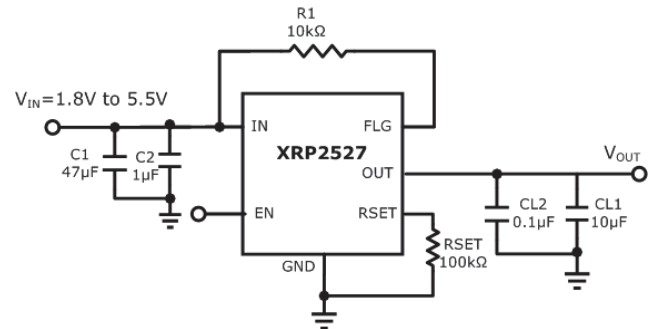



XRP2527 - XRP2528

Single/Dual Channel Adjustable Current Power Distribution Switch

PACKAGE SPECIFICATION

8-PIN TDFN

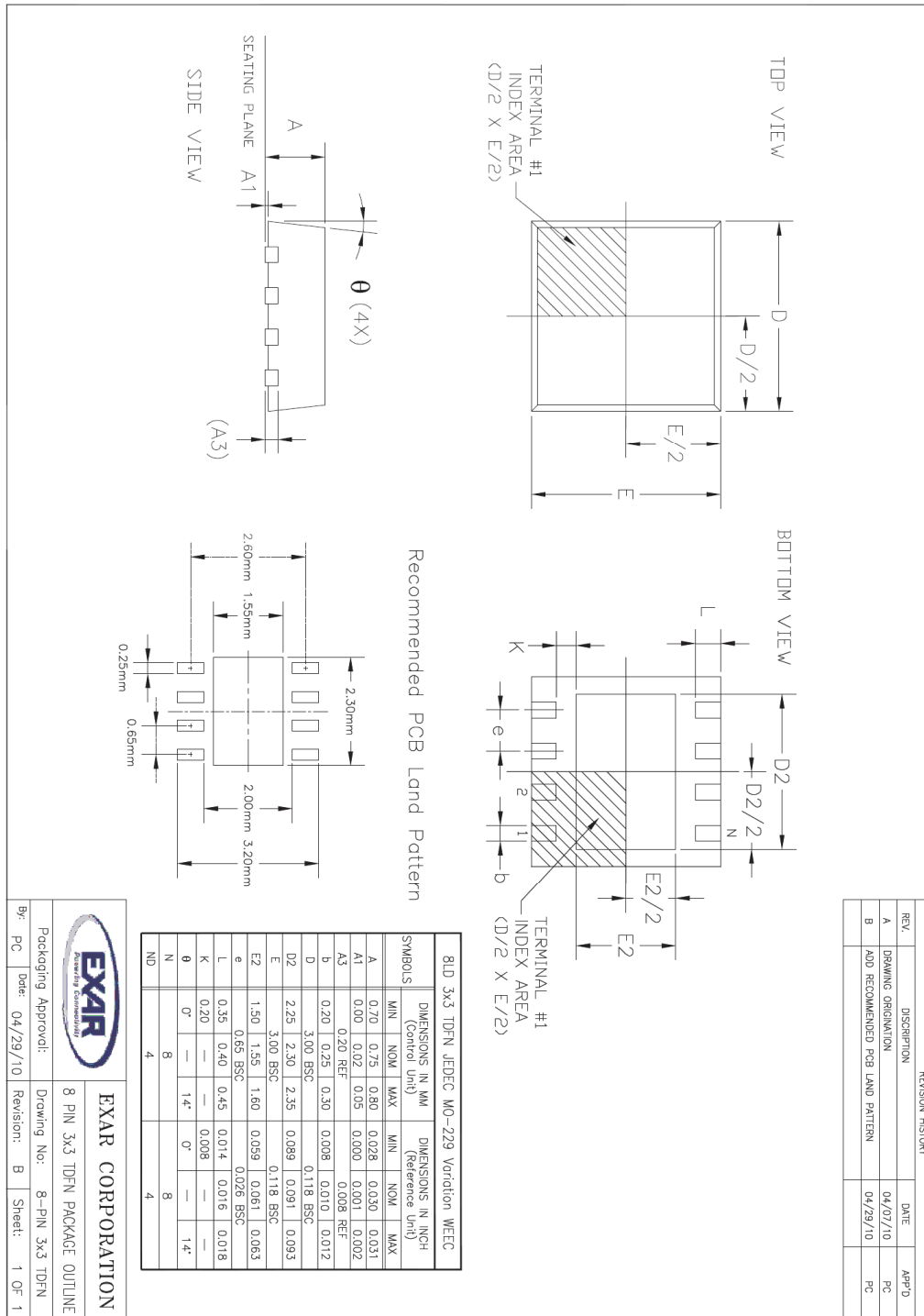

REVISION HISTORY		
REV.	DESCRIPTION	DATE
A	DRAWING ORIGINATOR	04/07/10
B	ADD RECOMMENDED PCB LAND PATTERN	04/29/10
		App'D PC PC



XRP2527 - XRP2528

Single/Dual Channel Adjustable Current Power Distribution Switch

10-PIN TDFN

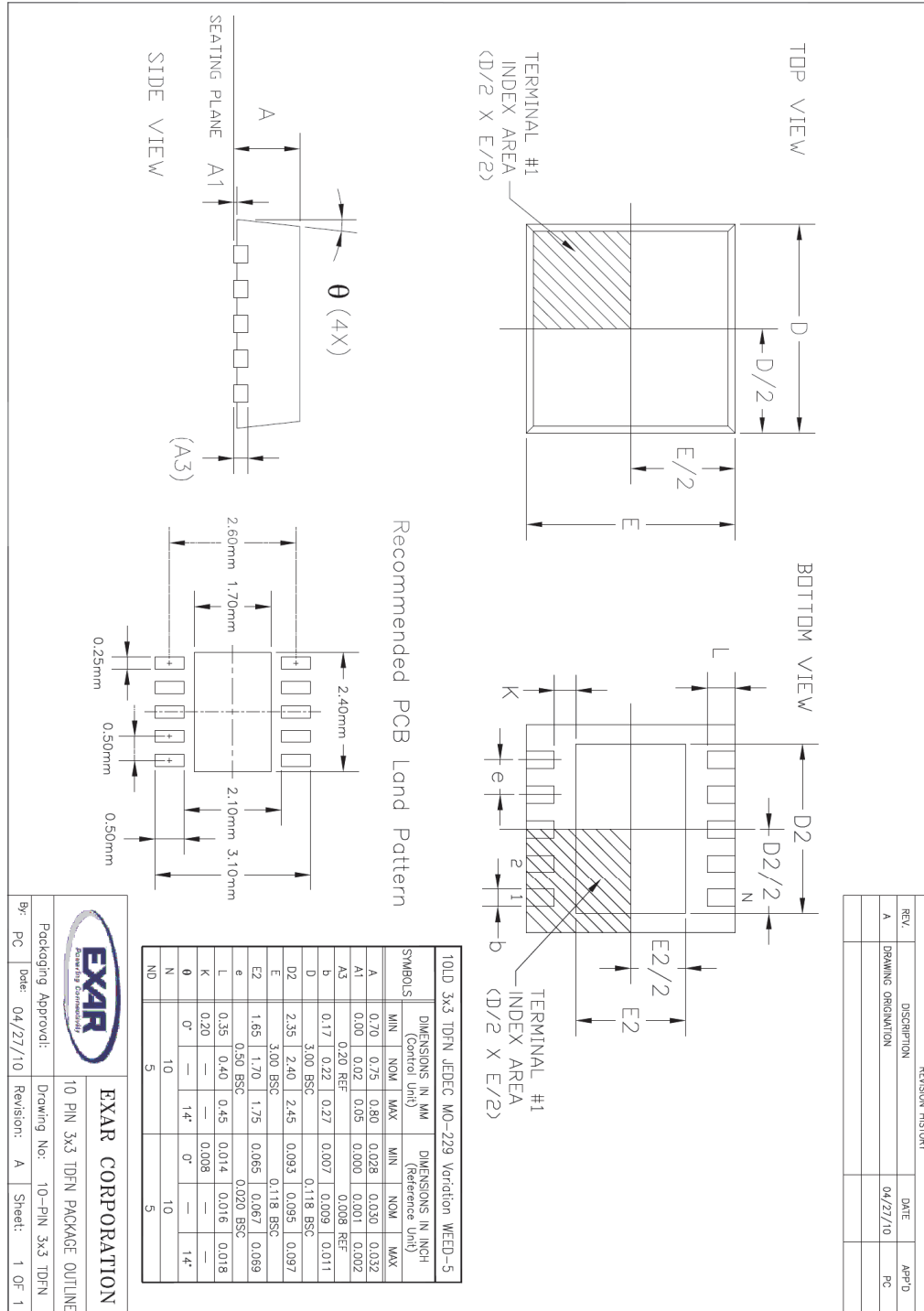

REVISION HISTORY			
REV.	DESCRIPTION	DATE	APP'D
A	DRAWING ORIGINATOR	04/27/10	PC

EXAR CORPORATION

10 PIN 3x3 TDFN PACKAGE OUTLINE

By: PC	Date: 04/27/10	Revision: A	Sheet: 1 OF 1
Packaging Approval:		Drawing No: 10-PIN 3x3 TDFN	



XRP2527 - XRP2528

Single/Dual Channel Adjustable Current Power Distribution Switch

REVISION HISTORY

Revision	Date	Description
1.0.0	05/13/2011	Initial release of datasheet
1.1.0	07/14/2011	Corrections of typographical errors

FOR FURTHER ASSISTANCE

Email:

customersupport@exar.com

Exar Technical Documentation:

<http://www.exar.com/TechDoc/default.aspx?>

EXAR CORPORATION

HEADQUARTERS AND SALES OFFICES

48720 Kato Road

Fremont, CA 94538 – USA

Tel.: +1 (510) 668-7000

Fax: +1 (510) 668-7030

www.exar.com



NOTICE

EXAR Corporation reserves the right to make changes to the products contained in this publication in order to improve design, performance or reliability. EXAR Corporation assumes no responsibility for the use of any circuits described herein, conveys no license under any patent or other right, and makes no representation that the circuits are free of patent infringement. Charts and schedules contained here in are only for illustration purposes and may vary depending upon a user's specific application. While the information in this publication has been carefully checked; no responsibility, however, is assumed for inaccuracies.

EXAR Corporation does not recommend the use of any of its products in life support applications where the failure or malfunction of the product can reasonably be expected to cause failure of the life support system or to significantly affect its safety or effectiveness. Products are not authorized for use in such applications unless EXAR Corporation receives, in writing, assurances to its satisfaction that: (a) the risk of injury or damage has been minimized; (b) the user assumes all such risks; (c) potential liability of EXAR Corporation is adequately protected under the circumstances.

Reproduction, in part or whole, without the prior written consent of EXAR Corporation is prohibited.