

Power Sequencing Controllers

The Intersil ISL8723 and ISL8724 are 4 channel sequencers controlling the on and off sequence of voltages with under voltage supply fault protection and a “sequence completed” signal (RESET#). For larger systems, more than 4 voltages can be sequenced by a simple connection of multiple IC’s. These sequencers use an integrated charge pump to drive 4 external low-cost N-channel MOSFET switch gates above the IC bias voltage by 5.3V. These IC’s can be biased from and control any supply from 2.5V to 5V and additionally monitor any voltage above 0.7V. Individual product descriptions are below.

The four channel **ISL8723** (ENABLE input), **ISL8724** (ENABLE# input) offer the designer 4 voltage control when it is required that all four rails are in minimal compliance prior to turn on and that compliance must be maintained during operation. The **ISL8723** has a low power standby mode when it is disabled suitable for battery powered applications.

External resistors provide flexible voltage threshold programming of monitored voltages. Delay and sequencing timing are programmable by external capacitors for both ramp up and ramp down.

Ordering Information

| PART NUMBER | PART MARKING | TEMP. RANGE (°C) | PACKAGE | PKG. DWG. # |
|---------------------|---------------------|------------------|-------------------------------------|-------------|
| ISL8723IRZ (Note) | 8723IRZ | -40 to +85 | 24 Ld 4x4 QFN (Pb-free) | L24.4x4 |
| ISL8724IRZ (Note) | 8724IRZ | | | L24.4x4 |
| ISL8723IRZ-T (Note) | 8723IRZ | -40 to +85 | 24 Ld 4x4 QFN (Pb-free) Tape & Reel | L24.4x4 |
| ISL8724IRZ-T (Note) | 8724IRZ | | | L24.4x4 |
| ISL8723EVAL1 | Evaluation Platform | | | |

NOTE: Intersil Pb-free plus anneal products employ special Pb-free material sets; molding compounds/die attach materials and 100% matte tin plate termination finish, which are RoHS compliant and compatible with both SnPb and Pb-free soldering operations. Intersil Pb-free products are MSL classified at Pb-free peak reflow temperatures that meet or exceed the Pb-free requirements of IPC/JEDEC J STD-020.

Features

- Enables arbitrary turn-on and turn-off sequencing of up to four power supplies (0.7V to 5V)
- Operates from 2.5V to 5V supply voltage
- Supplies $V_{DD} + 5.3V$ of charge pumped gate drive
- Adjustable voltage slew rate for each rail
- Multiple sequencers can be easily daisy-chained to sequence an infinite number of independent voltages
- Glitch immunity
- Under voltage lockout for each monitored supply voltage
- 30 μ A Sleep State (**ISL8723**)
- Active high (**ISL8723**) or low (**ISL8724**) ENABLE# input
- Pb-free plus anneal available (RoHS compliant) QFN Package

Applications

- Graphics cards
- FPGA/ASIC/microprocessor/PowerPC supply sequencing
- Network Routers
- Telecommunications Systems

Pinout

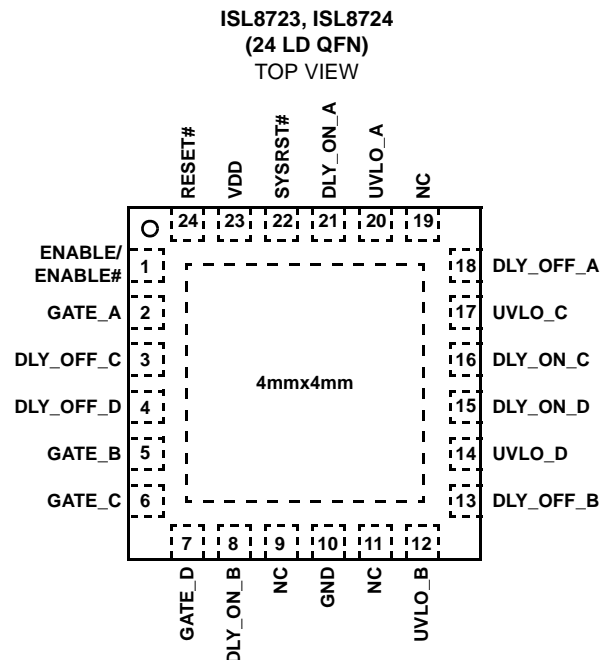

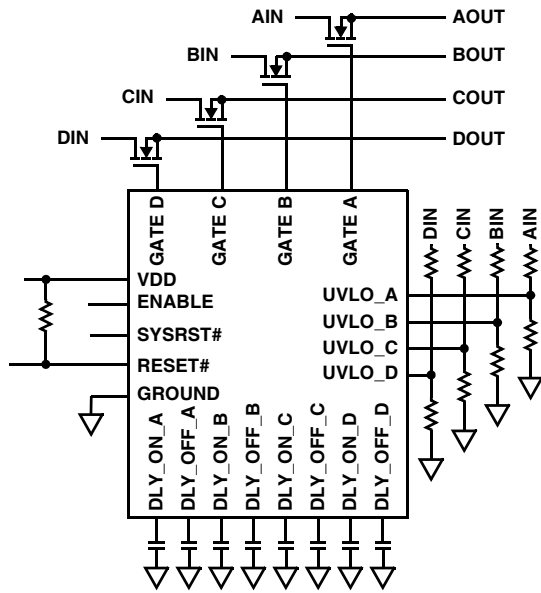

FIGURE 1. TYPICAL ISL8723 APPLICATION USAGE

Pin Descriptions

| PIN # | PIN NAME | FUNCTION | DESCRIPTION |
|-------|--------------------|---|---|
| 23 | VDD | Chip Bias | Bias IC from nominal 2.5V to 5V |
| 10 | GND | Bias Return | IC ground |
| 1 | ENABLE/ ENABLE# | Input to start on/off sequencing. | Input to initiate the start of the programmed sequencing of supplies on or off. Enable functionality is disabled for 10ms after UVLO is satisfied. ISL8723 has ENABLE. ISL8724 has ENABLE#. |
| 24 | RESET# | RESET# Output | RESET# provides a high signal ~160ms after all GATEs are fully enhanced. This delay is for stabilization of output voltages. RESET# will assert low upon any UVLO not being satisfied or ENABLE/ENABLE# being deasserted. The RESET# output is an open drain N-channel FET and is guaranteed to be in the correct state for VDD down to 1V and is filtered to ignore fast transients on VDD and UVLO_X. |
| 20 | UVLO_A | Under Voltage Lock Out/Monitoring Input | These inputs provide for a programmable UV lockout referenced to an internal 0.631V reference and are filtered to ignore short (<7μs) transients below programmed UVLO level. |
| 12 | UVLO_B | | |
| 17 | UVLO_C | | |
| 14 | UVLO_D | | |
| 21 | DLY_ON_A | Gate On Delay Timer Output | Allows for programming the delay and sequence for V _{OUT} turn-on using a capacitor to ground. Each cap is charged with 1μA, 10ms after turn-on initiated by ENABLE/ENABLE# with an internal current source providing delayed enhancement of the associated FETs GATE to turn-on. |
| 8 | DLY_ON_B | | |
| 16 | DLY_ON_C | | |
| 15 | DLY_ON_D | | |
| 18 | DLY_OFF_A | Gate Off Delay Timer Output | Allows for programming the delay and sequence for V _{OUT} turn-off through ENABLE/ENABLE# via a capacitor to ground. Each cap is charged with a 1μA internal current source to an internal reference voltage causing the corresponding gate to be pulled down thus turning-off the FET. |
| 13 | DLY_OFF_B | | |
| 3 | DLY_OFF_C | | |
| 4 | DLY_OFF_D | | |
| 2 | GATE_A | FET Gate Drive Output | Drives the external FETs with a 10μA current source to soft start ramp into the load. During sequence off, 10μA is sunk from this pin to control the FET turn-off. During a turn-off due to a fault, the gate will sink ~75mA to ensure a rapid turn-off. |
| 5 | GATE_B | | |
| 6 | GATE_C | | |
| 7 | GATE_D | | |

Pin Descriptions (Continued)

| PIN # | PIN NAME | FUNCTION | DESCRIPTION |
|----------|------------|------------------|--|
| 22 | SYSRST# | System Reset I/O | <p>As an input, allows for immediate and unconditional latch-off of all GATE outputs when driven low. This pin can also be used to initiate the programmed sequence with 'zero' wait (no 10ms stabilization delay) from input signal on this pin being driven high to first GATE.</p> <p>As an output when there is a UV condition this pin pulls low. If common to other SYSRST# pins in a multiple IC configuration it will cause immediate and unconditional latch-off of all other GATEs on all other ISL872x sequencers.</p> <p>This pin is released to go high once all UVLO and enable conditions are satisfied and is pulled low concurrent with the last GATE being turned off after EN disabled.</p> |
| 9,11, 19 | No Connect | No Connect | No Connect |

Absolute Maximum Ratings

| | |
|--------------------------------------|--------------------------------|
| V _{DD} | +6.0V |
| GATE | -0.3V to V _{DD} +6V |
| UVLO, ENABLE, ENABLE#, SYSRST# | -0.3V to V _{DD} +0.3V |
| RESET#, DLY_ON, DLYOFF | -0.3V to V _{DD} +0.3V |

Thermal Information

| | | |
|--|----------------------|----------------------|
| Thermal Resistance (Typical, Notes 1, 2) | θ_{JA} (°C/W) | θ_{JC} (°C/W) |
| 4 x 4 QFN Package | 48 | 9 |
| Maximum Junction Temperature | +125°C | |
| Maximum Storage Temperature Range | -65°C to +150°C | |

Operating Conditions

| | |
|--|----------------|
| V _{DD} Supply Voltage Range | +2.5V to +5.0V |
| Temperature Range (T _A) | -40°C to +85°C |

CAUTION: Stresses above those listed in "Absolute Maximum Ratings" may cause permanent damage to the device. This is a stress only rating and operation of the device at these or any other conditions above those indicated in the operational sections of this specification is not implied.

NOTES:

1. θ_{JA} is measured in free air with the component mounted on a high effective thermal conductivity test board with "direct attach" features. See Tech Brief TB379.
2. For θ_{JC} , the "case temp" location is the center of the exposed metal pad on the package underside.
3. All voltages are relative to GND, unless otherwise specified.

Electrical Specifications V_{DD} = 3.3V to +5V, T_A = T_J = -40°C to +85°C, Unless Otherwise Specified.

| PARAMETER | SYMBOL | TEST CONDITIONS | MIN | TYP | MAX | UNIT |
|---|-------------------------------------|--|------|-----------------------|-------|------|
| UVLO | | | | | | |
| Undervoltage Lockout Falling Threshold | V _{UVLOvth} | T _A = T _J = +25°C | 619 | 631 | 647 | mV |
| Undervoltage Lockout Falling Threshold | V _{UVLOvth} | | 604 | 631 | 656 | mV |
| Undervoltage Lockout Hysteresis | V _{UVLOhys} | | - | 9 | - | mV |
| Undervoltage Lockout Threshold Range | RUVLOvth | Max V _{UVLOvth} - Min V _{UVLOvth} | - | 6 | 18 | mV |
| Undervoltage Lockout Delay | TUVLOdel | ENABLE satisfied | - | 10 | - | ms |
| Transient Filter Duration | tFIL | V _{DD} , UVLO, ENABLE glitch filter | - | 7 | - | µs |
| DELAY ON/OFF | | | | | | |
| Delay Charging Current | DLY_ichg | V _{DLY} = 0V | 0.9 | 1 | 1.115 | µA |
| Delay Charging Current Range | DLY_ichg_r | DLY_ichg(max) - DLY_ichg(min) | - | 0.01 | 0.05 | µA |
| Delay Threshold Voltage | DLY_Vth | | 1.21 | 1.273 | 1.32 | V |
| ENABLE/ENABLE#, RESET# AND SYSRST# I/O | | | | | | |
| ENABLE Threshold | V _{ENh} | Measured at V _{DD} = 5V | - | 1.28 | 1.35 | V |
| ENABLE# Threshold | V _{ENh} | | - | 0.5 V _{DD} | - | V |
| ENABLE/ENABLE# Hysteresis | V _{ENh} - V _{ENl} | Measured at V _{DD} = 5V | - | 0.1 | 0.2 | V |
| ENABLE/ENABLE# Lockout Delay | TdelEN_LO | UVLO satisfied, EN to DLY_ON | - | 10 | - | ms |
| ENABLE/ENABLE# Input Capacitance | Cin_en | | - | 5 | - | pF |
| RESET# Pull-up Voltage | Vpu_rst | | - | V _{DD} | - | V |
| RESET# Pull-Down Current | I _{RSTpd5} | V _{DD} = 5V, \overline{RST} = 0.1V | - | 13 | - | mA |
| RESET# Delay after GATE High | T _{RSTdel} | GATE = V _{DD} +5V | - | 160 | - | ms |
| RESET# Output Low | V _{RSTl} | Measured at V _{DD} = 5V, 1mA sourcing current | - | - | 0.1 | V |
| RESET Output Capacitance | Cout_rst | | - | 10 | - | pF |
| SYSRST# Pull-up Voltage | Vpu_srst | | - | V _{DD} -0.5V | - | V |
| SYSRST# Pull-up Current | Ipu_srst | V _{DD} = 3.3V, SYSRST# = 0.5V | - | 12 | - | µA |
| SYSRST# Pull Down Current | Ipu_5 | V _{DD} = 5V | - | 2.7 | - | µA |
| SYSRST# Low Output Voltage | Vol_srst | V _{DD} = 5V, I _{OUT} = 100µA | - | - | 0.1 | V |

ISL8723, ISL8724

Electrical Specifications $V_{DD} = 3.3V$ to $+5V$, $T_A = T_J = -40^\circ C$ to $+85^\circ C$, Unless Otherwise Specified. (Continued)

| PARAMETER | SYMBOL | TEST CONDITIONS | MIN | TYP | MAX | UNIT |
|------------------------------------|-------------------------|--|-----------------------|-----------------------|------|------|
| SYSRST# Output Capacitance | Cout_srst | | - | 10 | - | pF |
| SYSRST# Low to GATE Turn-off | T _{delSYS_G_1} | GATE = 80% of V _{DD} +5V | - | 40 | - | ns |
| SYSRST# High to GATE Turn-on | T _{delSYS_G_2} | GATE = 50% of V _{DD} +5V | - | 0.4 | - | ms |
| GATE | | | | | | |
| GATE Turn-On Current | I _{GATEon} | GATE = 0V | 8.3 | 10.2 | 12.5 | μA |
| GATE Turn-Off Current | I _{GATEoff_l} | GATE = V _{DD} , Disabled | -12.5 | -10.2 | -8.3 | μA |
| GATE Current Range | I _{GATE_range} | Within IC I _{GATE} max-min | - | 0.6 | 3 | μA |
| GATE Pull-Down High Current | I _{GATEoff_h} | GATE = V _{DD} , UVLO = 0V | - | 75 | - | mA |
| GATE High Voltage | V _{GATEh5} | V _{DD} = 5V | V _{DD} +5.3V | V _{DD} +5.6V | - | V |
| GATE Low Voltage | V _{GATEl} | Gate Low Voltage, V _{DD} = 1V | - | 0.01 | 0.1 | V |
| BIAS | | | | | | |
| IC Supply Current | I _{VDD_5V} | V _{DD} = 5V, Enabled and static | - | 0.27 | 0.31 | mA |
| ISL8723 Stand By IC Supply Current | I _{VDD_sb} | V _{DD} = 5V, ENABLE = 0V | - | 30 | 40 | μA |
| V _{DD} Power On Reset | V _{DD_POR} | V _{DD} rising | - | 2.2 | 2.41 | V |

ISL8723, ISL8724 Descriptions and Operation

The ISL8723 and ISL8724 sequencers are quad voltage sequencing controllers designed for use in multiple-voltage systems requiring power sequencing of various supply voltages. Individual voltage rails are gated on and off by external N-Channel MOSFETs, the gates of which are driven by an internal charge pump to $\sim V_{DD} + 5.6V$ (VQP) in a user programmed sequence.

With the ISL8723 the ENABLE must be asserted high and all four voltages to be sequenced must be above their respective user programmed Under Voltage Lock Out (UVLO) levels before programmed output turn on sequencing can begin. Sequencing and delay determination is accomplished by the choice of external cap values on the DLY_ON and DLY_OFF pins. The SYSRST# goes high once all 4 UVLO inputs and ENABLE are satisfied. Once all 4 UVLO inputs and ENABLE are satisfied for 10ms, the four DLY_ON caps are simultaneously charged with 1μA current sources to the DLY_Vth level of 1.28V. As each DLY_ON pin reaches the DLY_Vth level its associated GATE will then turn-on with a 10μA source current to the VQP voltage of V_{DD}+5.6V. Thus all four GATES will sequentially turn on. Once at DLY_Vth the DLY_ON pins will discharge to be ready when next needed. After the entire turn on sequence has been completed and all GATES have reached the charge pumped voltage (VQP), a 160ms delay is started to ensure stability after which the RESET# output will be released to go high. Subsequent to turn-on, if any input falls below its UVLO point for longer than the glitch filter period, T_{FIL} ($\sim 7\mu s$) this is considered a fault. RESET#, SYSRST# and all GATES are simultaneously pulled low. In this mode the

GATES are pulled low with $\sim 75mA$. Normal shutdown mode is entered when no UVLO is violated and the ENABLE is deasserted. When ENABLE is deasserted, RESET# is asserted and pulled low. Next, all four shutdown ramp caps on the DLY_OFF pins are charged with a 1μA source and when any ramp-cap reaches DLY_Vth, a latch is set and a 10μA current is sunk on the respective GATE pin to turn off its external MOSFET. When the falling GATE voltage is approximately 1.5V, the GATE is pulled down the rest of the way at a higher current level to ensure a hard turn-off. Each individual external FET is thus turned off removing the voltages from the load in the programmed sequence. The SYSRST# will pull low concurrent with the last GATE being pulled low.

The ISL8723 and ISL8724 have the same functionality except for the complimentary ENABLE active polarity with the ISL8724 having an ENABLE# input. Additionally the ISL8723 also has a low power sleep state when disabled.

Upon bias the SYSRST# and RESET# pins are held low before bias voltage = 1V.

The SYSRST# has both an input and output function. As an output the SYSRST# pin is useful when implementing multiple sequencers in a design needing simultaneous shutdown as with a kill switch across all sequencers. Once any UVLO is unsatisfied for longer than T_{FIL} the related SYSRST# will pull low and pull all other SYSRST# pins low that are on a common connection thus unconditionally shutting down all outputs across multiple sequencers. As an input, if it is pulled low all GATES will be unconditionally shut off and RESET# pulled low, see Figure 17. This pin can also be used as a 'no wait' enabling input, if all inputs (ENABLE and UVLO) are satisfied it does not wait through

the ~10ms enable delay to initiate DLY_ON cap charging when released to go high. This feature can be used where 4 voltages can be monitored in addition to a on-off switch position or, in the case of the ISL8724 a present pin pull down.

Restart of the turn on sequence is automatic once all requirements are met. This allows for no interaction between the sequencer and a controller IC if so desired. If no capacitors are connected between DLY_ON or DLY_OFF pins and ground then all such related GATES start to turn on immediately after the 10ms ($T_{UVLOdel}$) ENABLE stabilization time out has expired and the GATES start to immediately turn off when ENABLE is deasserted.

Table 1 illustrates the nominal time delay from the start of charging to the 1.27V reference for various capacitor values on the DLY_X pins. This table does not include the 10ms of enable lock out delay during a start up sequence but represents the time from the end of the enable lock out delay to the start of GATE transition. There is no enable lock out delay for a sequence off, so this table illustrates the delay to GATE transition from a disable signal.

TABLE 1.

| NOMINAL DELAY TO SEQUENCING THRESHOLD | |
|---------------------------------------|-----------|
| DLY PIN CAPACITANCE | TIME (ms) |
| Open | 0.02 |
| 100pF | 0.135 |
| 1000pF | 1.35 |
| 0.01 μ F | 13.5 |
| 0.1 μ F | 135 |
| 1 μ F | 1350 |

NOTE: Nom. $T_{DEL_SEQ} = dly_cap (\mu F) \times 1.35M\Omega$

Figure 2 illustrates the turn-on and Figure 3 the nominal turnoff timing diagrams of the **ISL8723** and **ISL8724** product.

Note the delay and flexible sequencing possibilities. Multiple series, parallel or adjustable capacitors can be used to easily fine tune timing between that offered by standard value capacitors.

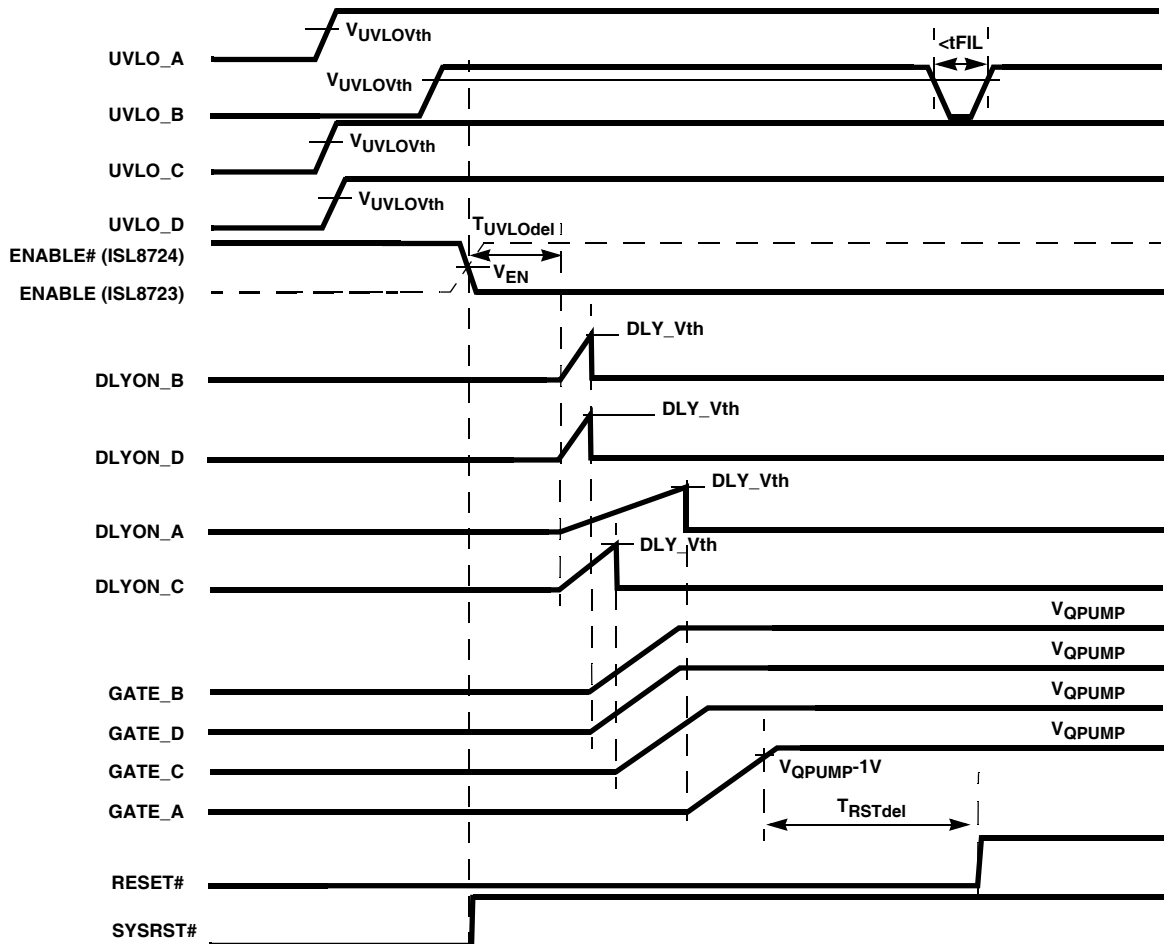

FIGURE 2. ISL8723, ISL8724 TURN-ON AND GLITCH RESPONSE TIMING DIAGRAM

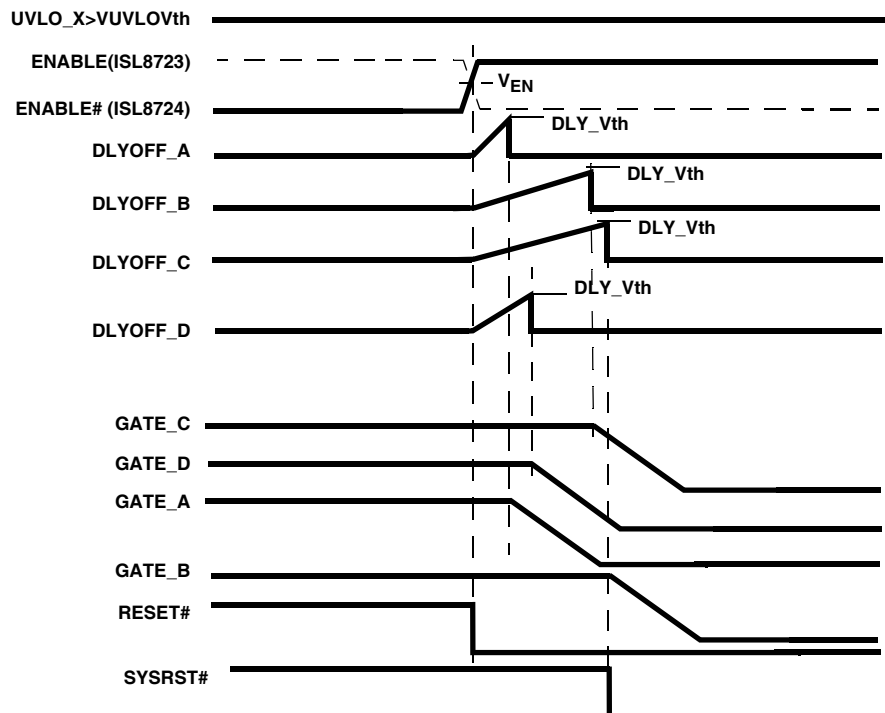

FIGURE 3. ISL8723, ISL8724 TURN-OFF TIMING DIAGRAM

Typical Performance Curves

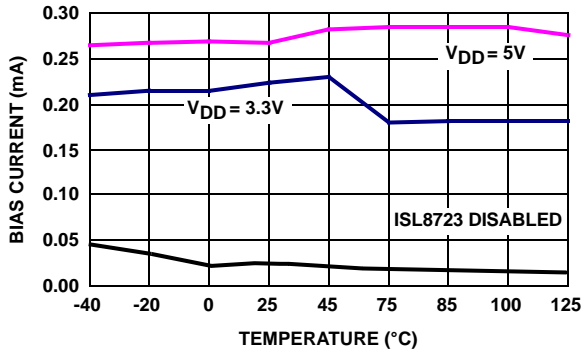

FIGURE 4. BIAS CURRENT

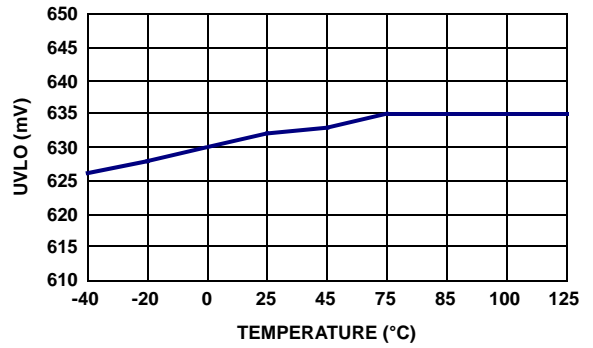

FIGURE 5. UVLO THRESHOLD VOLTAGE

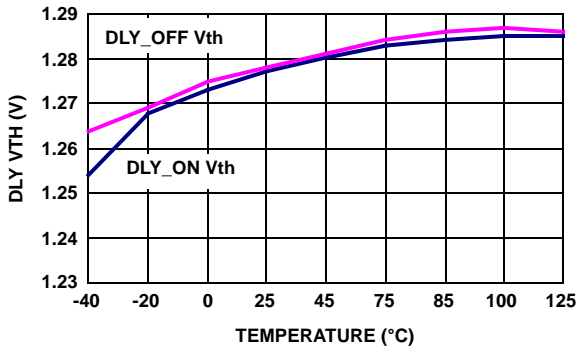

FIGURE 6. DLY THRESHOLD VOLTAGE

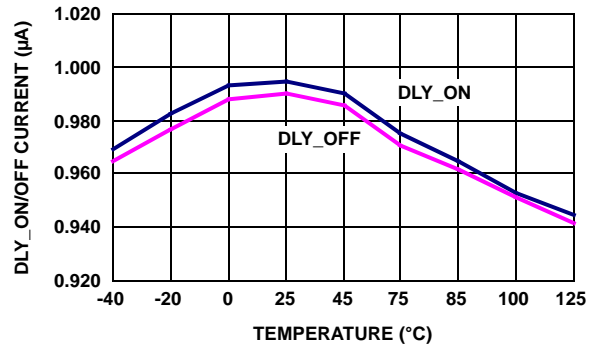

FIGURE 7. DLY CHARGE CURRENT

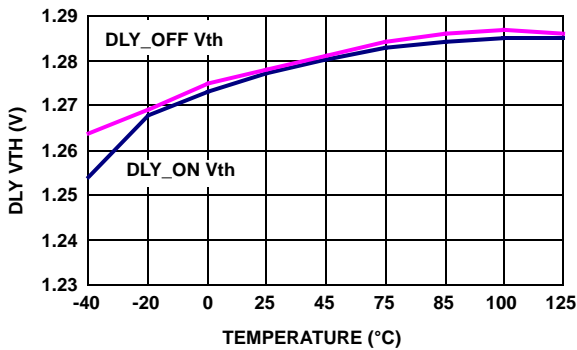

FIGURE 8. BIAS POWER ON RESET

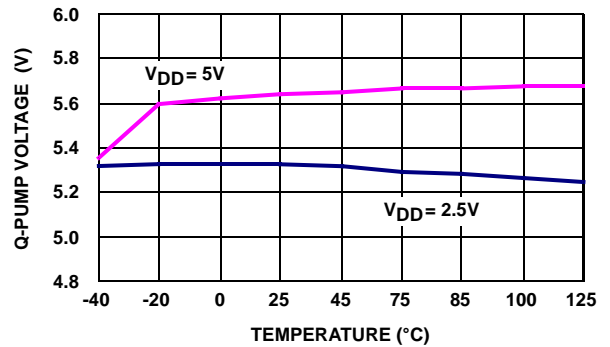

FIGURE 9. CHARGE PUMP VOLTAGE

Typical Performance Curves (Continued)

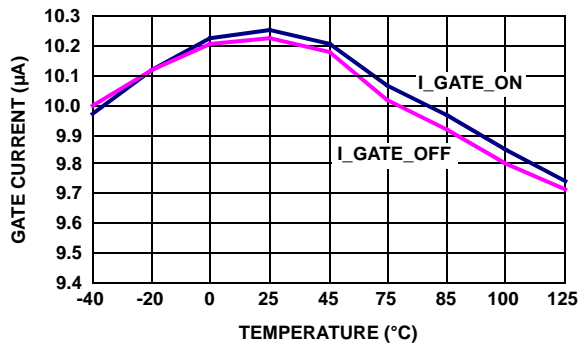

FIGURE 10. GATE TURN-OFF/ON (DIS)CHARGE CURRENT

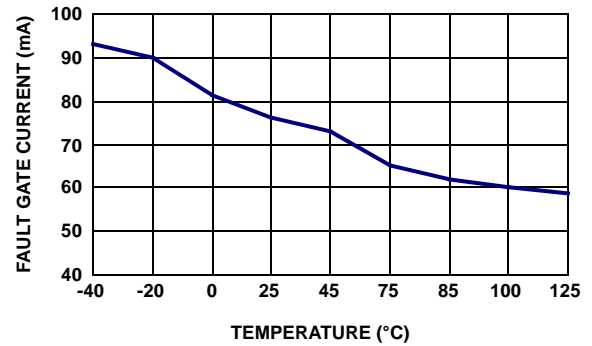

FIGURE 11. FAULT GATE TURN-OFF SINK CURRENT

Using the ISL8723EVAL1 Platform

The **ISL8723EVAL1** platform allows evaluation of the ISL8723, easily providing access to the critical nodes, see Figure 21 for schematic and Figure 22 for a photograph of the evaluation platform.

The board has a SMD layout with a **ISL8723** illustrating the possible small implementation size for a typical four rail sequencing application. There are bias and function labeled test points to give access to the IC pins for evaluation. Remember that significant current or capacitive loading of particular I/O pins will affect functionality and performance.

The default configuration of the **ISL8723EVAL1** circuit was built around the following design assumptions:

1. Using the **ISL8723IR**
2. The four supplies being sequenced are 5V (IN_A), 3.3V (IN_B), 2.5V (IN_D) and 1.5V (IN_C), the UVLO levels are ~80% of nominal voltages. Resistors chosen such that the total resistance of each divider is ~ 10k using standard value resistors to approximate 80% of nominal voltage supply = 0.63V on UVLO input.
3. The desired order turn-on sequence is 5V first, then 3.3V about 12ms later then the 2.5V supply about 19ms later and lastly the 1.5V supply about 40ms later.
4. The desired turn-off sequence is first the 2.5V, the 3.3V 12ms later, then the 1.5V supply about 36ms later and lastly the 5V supply about 72ms after that.
5. LED off indicates sequence has completed and $\overline{\text{RESET}}$ has released and pulled high.

All scope shots are taken from ISL8723EVAL1 board. Figures 12 and 13 illustrate the desired turn-on and turn-off sequences respectively. The sequencing order and delay between voltages sequencing is set by external capacitance values so other than that illustrated can be accomplished.

Figures 14 and 15 illustrate the timing relationships between the EN input, RESET#, DLY and GATE outputs and the

VOUT voltage for a single channel being turned on and off respectively.

RESET# and SYSRST# functionality and relationships are shown in Figures 16 through 20.

Figure 16 illustrates that with a rising VDD, EN tied to VDD, and all UVLO configured to be satisfied, both the RESET# and SYSRST# are held low before VDD = 1V. SYSRST# is released to go high once the last UVLO is satisfied and RESET# is released to go high at $T_{\overline{\text{RST}}_{\text{del}}}$ after the last GATE is high.

Figure 17 shows GATE and RESET# response to SYSRST# being pulled low.

Figure 18 shows EN high to SYSRST# delay with all UVLO inputs satisfied.

Figure 19 shows RESET# and SYSRST# delay to EN pulled low.

Figure 20 shows ~8µs of glitch filter duration, tFIL during which the RESET# and SYSRST# do not react.

Typical Performance Waveforms

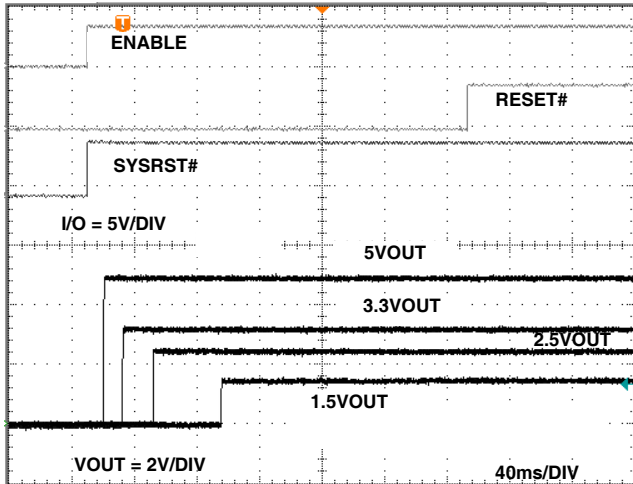

FIGURE 12. ISL8723 SEQUENCED TURN-ON

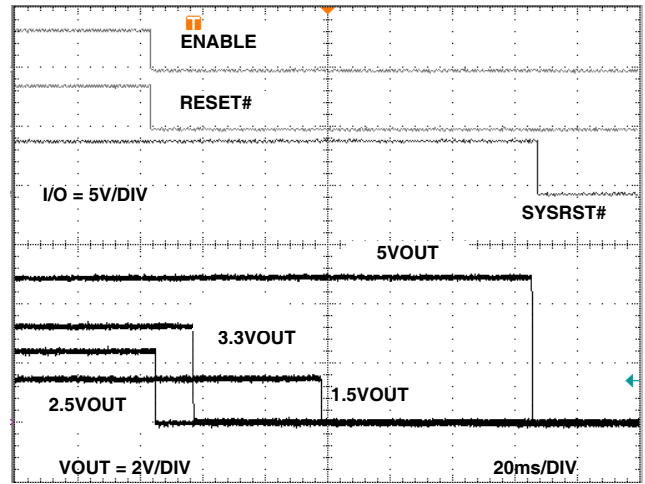

FIGURE 13. ISL8723 SEQUENCED TURN-OFF

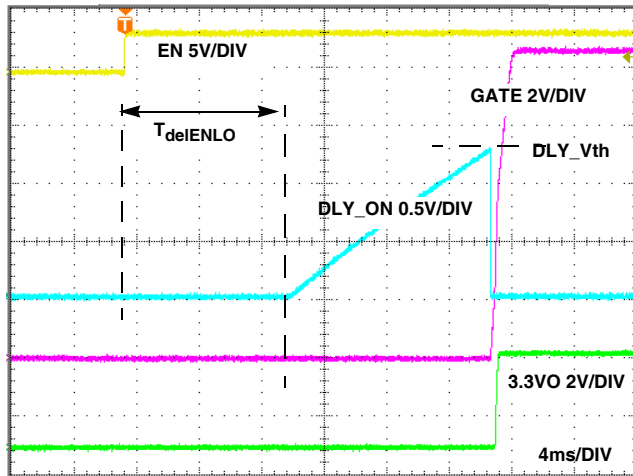

FIGURE 14. ISL8723 3.3V TURN-ON

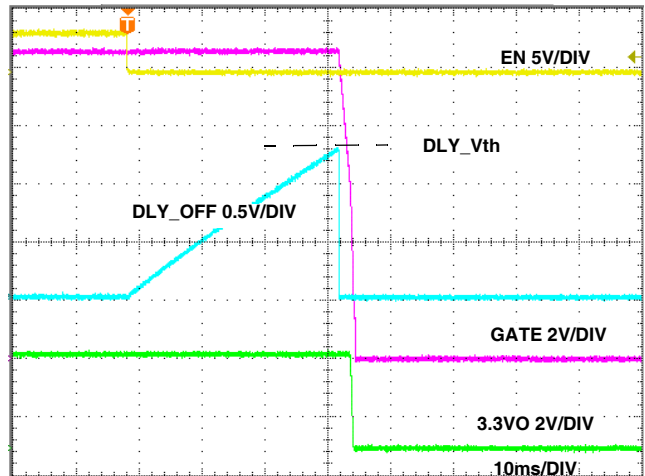

FIGURE 15. ISL8723 3.3V TURN-OFF

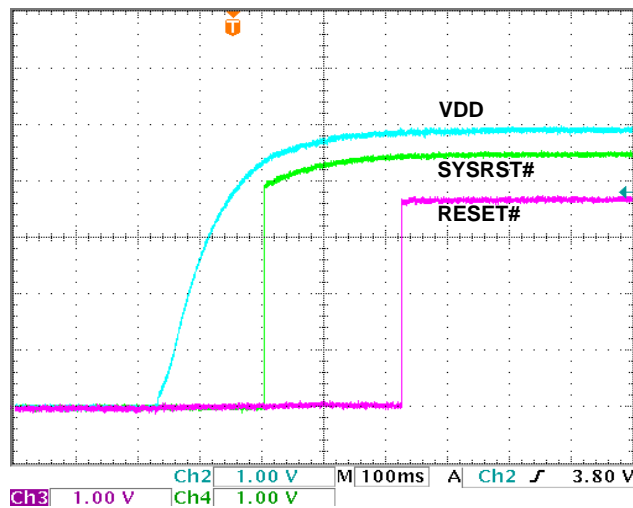

FIGURE 16. SYSRST# and RESET# vs VDD (EN = VDD, 4 UVLO > UVLO Vth)

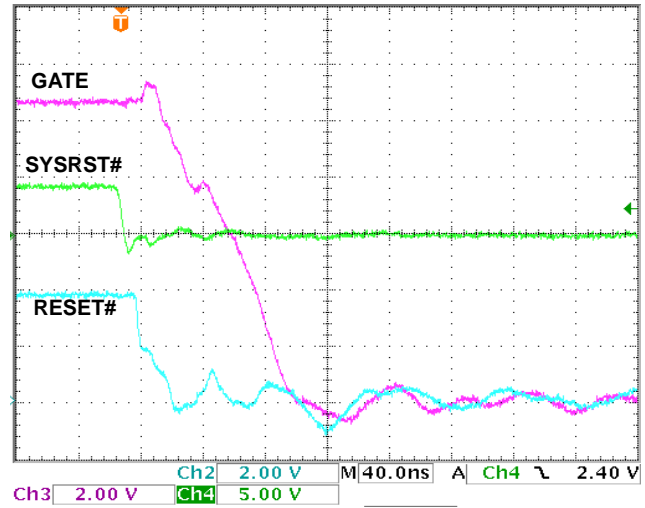

FIGURE 17. SYSRST# LOW to GATE and RESET# LOW

Typical Performance Waveforms (Continued)

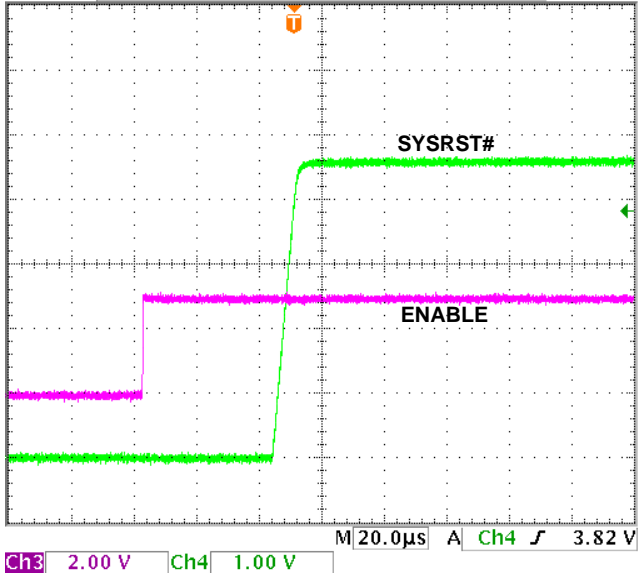

FIGURE 18. 4 UVLOs VALID, ENABLE HIGH to SYSRST HIGH

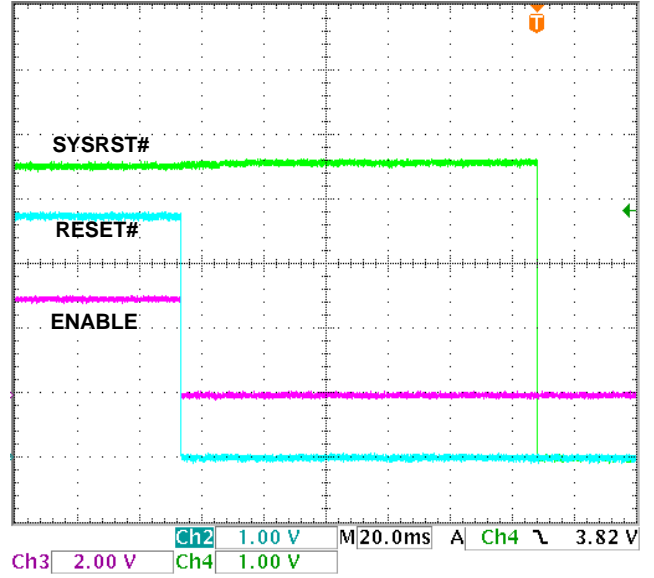

FIGURE 19. ENABLE LOW to RESE# and SYSRST LOW

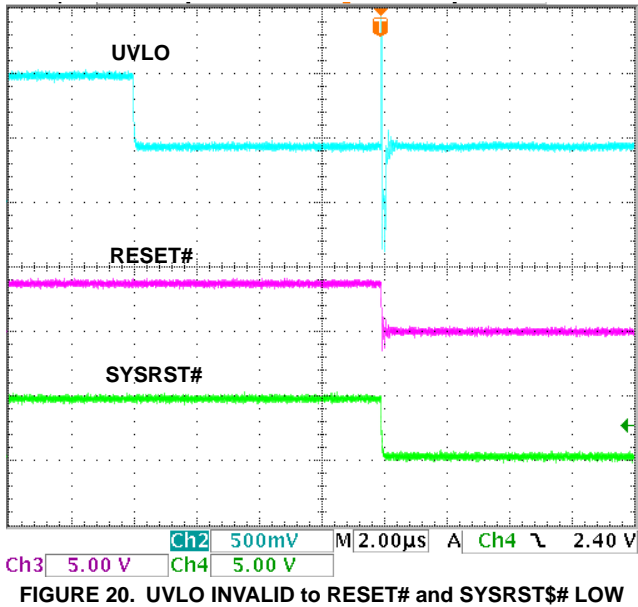

FIGURE 20. UVLO INVALID to RESE# and SYSRST# LOW

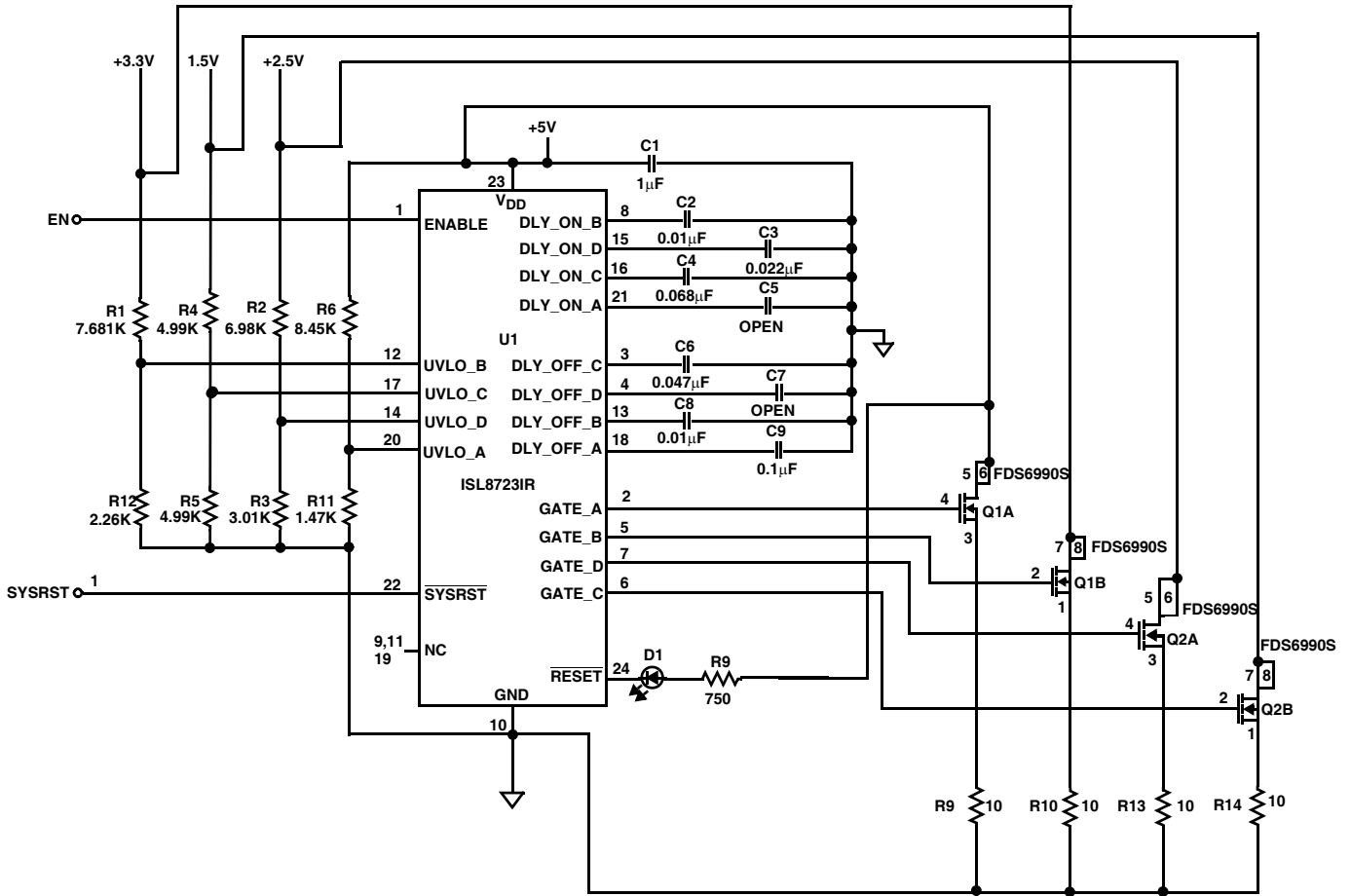

FIGURE 21. ISL8723EVAL1 BOARD SCHEMATIC

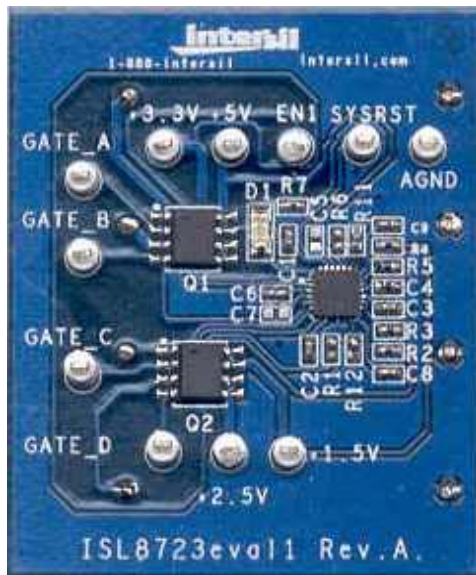

FIGURE 22. EVAL BOARD PHOTOGRAPH

ISL8723, ISL8724

TABLE 2. ISL872XSEQUAL1 BOARD COMPONENT LISTING

| COMPONENT DESIGNATOR | COMPONENT FUNCTION | COMPONENT DESCRIPTION |
|----------------------|--|--|
| U1 | ISL8723, 4 Supply Sequencer | Intersil, ISL8723IR 4 Supply Sequencer |
| Q1, Q2 | Voltage Rail Switches | FDS6990S or equiv, Dual N-Channel MOSFET |
| R6 | 5V to UVLO_A Resistor for Divider String | 8.45k Ω 1%, 0402 |
| R11 | UVLO_A to GND Resistor for Divider String | 1.47k Ω 1%, 0402 |
| R1 | 3.3V to UVLO_B Resistor for Divider String | 7.68k Ω 1%, 0402 |
| R12 | UVLO_B to GND Resistor for Divider String | 2.26k Ω 1%, 0402 |
| R2 | 2.5V to UVLO_D Resistor for Divider String | 6.98k Ω 1%, 0402 |
| R3 | UVLO_D to GND Resistor for Divider String | 3.01k Ω 1%, 0402 |
| R4 | 1.5V to UVLO_C Resistor for Divider String | 4.99k Ω 1%, 0402 |
| R5 | UVLO_D to GND Resistor for Divider String | 4.99k Ω 1%, 0402 |
| R9 | RESET LED Current Limiting Resistor | 750 Ω 10%, 0805 |
| C5 | 5V turn-on Delay Cap. A (~10ms) | DNP, 0402 |
| C9 | 5V turn-off Delay Cap. A (~140ms) | 0.1 μ F 10%, 6.3V, 0402 |
| C2 | 3.3V turn-on Delay Cap.B (~13ms) | 0.01 μ F 10%, 6.3V, 0402 |
| C8 | 3.3V turn-off Delay Cap. B (~13ms) | 0.01 μ F 10%, 6.3V, 0402 |
| C3 | 2.5V turn-on Delay Cap.D (~25ms) | 0.022 μ F 10%, 6.3V, 0402 |
| C7 | 2.5V turn-off Delay Cap. D (0ms) | DNP, 0402 |
| C4 | 1.5V turn-on Delay Cap. C (~100ms) | 0.068 μ F 10%, 6.3V, 0402 |
| C6 | 1.5V turn-off Delay Cap. C (~60ms) | 0.047 μ F 10%, 6.3V, 0402 |
| C1 | Decoupling Capacitor | 1 μ F, 0805 |
| D1 | RESET Indicating LED | 0805, SMD LEDs Red |
| R9 | 5V Load Resistor | 10 Ω 20%, 3W Carbon |
| R10 | 3.3V Load Resistor | 10 Ω 20%, 3W Carbon |
| R13 | 2.5V Load Resistor | 10 Ω 20%, 3W Carbon |
| R14 | 1.5V Load Resistor | 10 Ω 20%, 3W Carbon |
| | Test Points Labeled as to Function | |

Application Implementations

Multiple Sequencer Implementations

In order to control the sequencing of more than 4 voltages in applications where the integrity of these critical voltages must be assured prior to sequencing, several of the ISL8723 or ISL8724 devices can be configured together to accomplish this.

Figure 23 shows a typical multi sequencer implementation, note the common SYSRST# signal that asserts once all monitored voltages are valid allowing the sequence to initiate. The sequencing is straight forward across multiple sequencers as all DLY_ON capacitors will simultaneously start charging once all monitored voltages are valid and ~10ms after the common ENABLE input signal is delivered. This allows the choice of capacitors to be related to each other no different than using a single sequencer. When the common enabling signal is deasserted this configuration will then execute the turn-off sequence across all sequencers as programmed by the DLY_OFF capacitor values. With all the SYSRST# pins bused together once the on sequence is complete simultaneous shutdown upon any UVLO input failure is assured as the SYSRST# output will pull low, simultaneously turning off all GATE outputs.

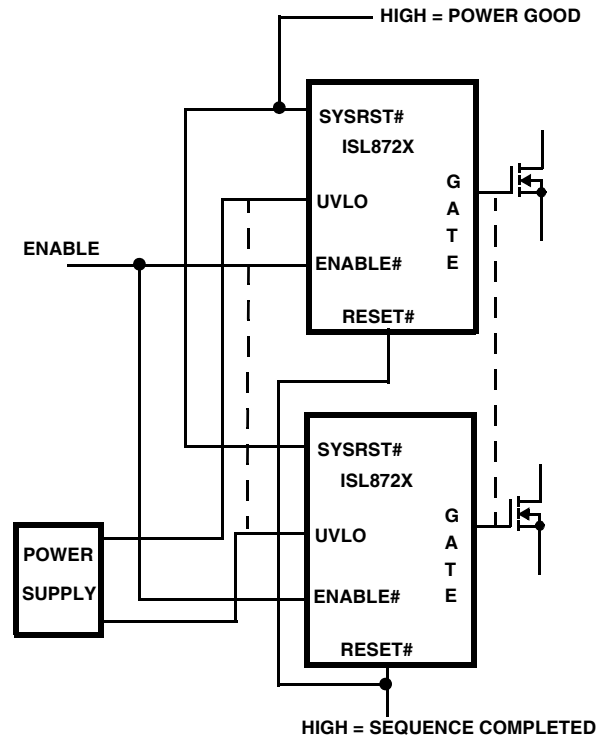

FIGURE 23. MULTIPLE ISL872X CONFIGURATION

All Intersil U.S. products are manufactured, assembled and tested utilizing ISO9000 quality systems. Intersil Corporation's quality certifications can be viewed at www.intersil.com/design/quality

Intersil products are sold by description only. Intersil Corporation reserves the right to make changes in circuit design, software and/or specifications at any time without notice. Accordingly, the reader is cautioned to verify that data sheets are current before placing orders. Information furnished by Intersil is believed to be accurate and reliable. However, no responsibility is assumed by Intersil or its subsidiaries for its use; nor for any infringements of patents or other rights of third parties which may result from its use. No license is granted by implication or otherwise under any patent or patent rights of Intersil or its subsidiaries.

For information regarding Intersil Corporation and its products, see www.intersil.com

