

# COMPACT POWER RELAY

## 1 POLE—25 A FOR AUTOMOTIVE APPLICATION

### FTR-P3 Series

RoHS compliant

#### ■ FEATURES

- Compact for high density packaging.  
(65% volume of previous generation FBR 51/52 Series).
- High contact capacity with proven contact material.  
(100,000 operations, 14 V, 25 A achieved, even with reduced size).
- 125°C version is available.
- Surface mount compatible version (reflowable) is available.
- Coil power savings  
(600mW nominal achieved with state-of-the-art magnetic analysis/design).
- Ease of PCB layout  
(all terminals on perimeter, coil and contact terminals separated).
- Optional over-voltage circuit breaking capability  
(0.6mm gap, contact our representative).
- Packaging for auto-insertion (tube packing, 30 relays/tube).
- RoHS compliant since date code: 0630  
Please see page 8 for more information

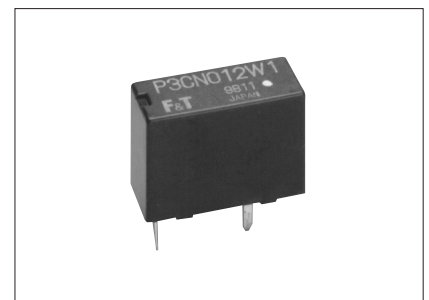

#### ■ ORDERING INFORMATION

\_\_\_\_\_ FTR-P3 C N 012 W1 \*\*\*  
 [Example] (a) (b) (c) (d) (e) (f)

(a)	Series Name	FTR-P3 Series
(b)	Contact Arrangement	C : 1 Form C
(c)	Contact Gap	N : 0.3mm gap P : 0.6mm gap
(d)	Nominal Coil Voltage	009 : 09VDC 010 : 10VDC 012 : 12VDC
(e)	Contact Material	W1 : Silver-tin oxide-indium
(f)	Custom Designation	Nil : Standard (85°C) -01 : High temperature (125°C) -05 : High temperature (125°C) and reflowable

Note: The part number stamped on the relay cover does not include "FTR".  
 Example: Ordering part number: FTR-P3CN012W1  
 Stamped on part number: P3CN012W1

#### ■ TYPICAL APPLICATIONS

Power window	Power seat	Tilt steering
Door lock	Wiper/IWW	Retractable antenna
Sun roof		

# FTR-P3 SERIES

## ■ SPECIFICATIONS

Item		Specification	
		Standard	High temperature version (-01, -05)
Contact	Arrangement	1 form C (SPDT)	
	Material	Silver-tin oxide-indium	
	Contact path Voltage Drop (Initial)	Maximum 100 mV (at 2 A 12 VDC)	
	Rating	25 A at 14VDC (locked motor load)	
	Maximum Carry Current	25 A / 1hour (25° C, 100% rated coil voltage)	
	Maximum Inrush Current (Reference)	35 A	
	Maximum Switching Current (Reference)	35 A at 16 VDC	
	Minimum Switching Load*1 (Reference)	1 A, 6 VDC	
Coil	Operating Ambient Temperature Range	-40° C to +85° C (no frost)	-40° C to +125° C (no frost)
	Storage Temperature Range	-40° C to +100° C (no frost)	-40° C to +125° C (no frost)
Timing Values	Operate (at nominal voltage)	Maximum 10ms (not including bounce)	
	Release (at nominal voltage)	Maximum 5ms (not including bounce, no diode) Maximum 15ms (not including bounce, with diode)	
Life	Mechanical	10 x 10 <sup>6</sup> operations minimum	
	Electrical	100 x 10 <sup>3</sup> operations minimum, 14 VDC, 25 A (locked motor load) (1 operation = 1 forward and 1 reverse)	
Other	Vibration Resistance	Operational	10-55Hz, 1.5mm double amplitude (=9.13G @ 55Hz)
	Shock Resistance	Operational	100 m/s <sup>2</sup> minimum (10G)
		Withstand, no damage	1, 000 m/s <sup>2</sup> minimum (100G)
	Insulation Resistance (initial)	100M ohms @500 VAC	
	Dielectric Withstanding Voltage (initial)	500 VAC	
	Weight	Approximately 5g	

\*1 Values when switching a resistive load at normal room temperature and humidity and in a clean environment. The minimum switching load varies with the switching frequency and operating environment.

# FTR-P3 SERIES

## ■ COIL DATA CHART

### FTR-P3 Series

Model	Nominal Coil Voltage	Coil Resistance ( $\pm 10\%$ at 20°C)	Must Operate Voltage	Must Release Voltage (at 20°C)	Coil Power at Nominal Voltage	Thermal Resistance (approx.)
FTR-P3CN009W1 ( )	9VDC	135 $\Omega$	5.5VDC (at 20° C) 6.9VDC (at 85° C)	0.75VDC	0.6W	73° C/W
FTR-P3CN010W1 ( )	10VDC	167 $\Omega$	6.3VDC (at 20° C) 7.9VDC (at 85° C)	0.9VDC	0.6W	73° C/W
FTR-P3CN012W1 ( )	12VDC	240 $\Omega$	7.3VDC (at 20° C) 9.2VDC (at 85° C)	1.0VDC	0.6W	73° C/W

Note: ( ) is "Nil", "-01", or "-05"

# FTR-P3 SERIES

## CHARACTERISTIC DATA

### 1. LIFE TEST (EXAMPLES)

- Test item  
14 V DC-25 A  
locked motor  
100K operations\* minimum  
0.25 seconds ON,  
9.75 seconds OFF

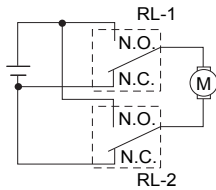

- Change of operate and release voltage

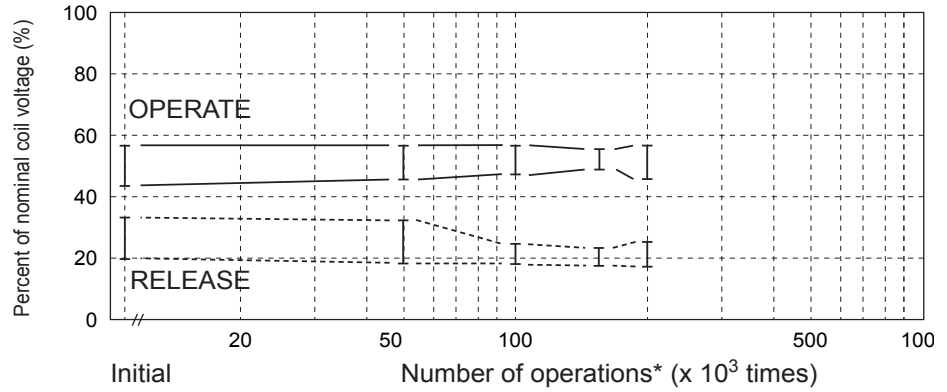

- Current wave form

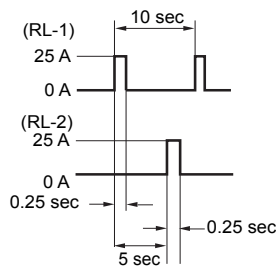

- Change in contact resistance

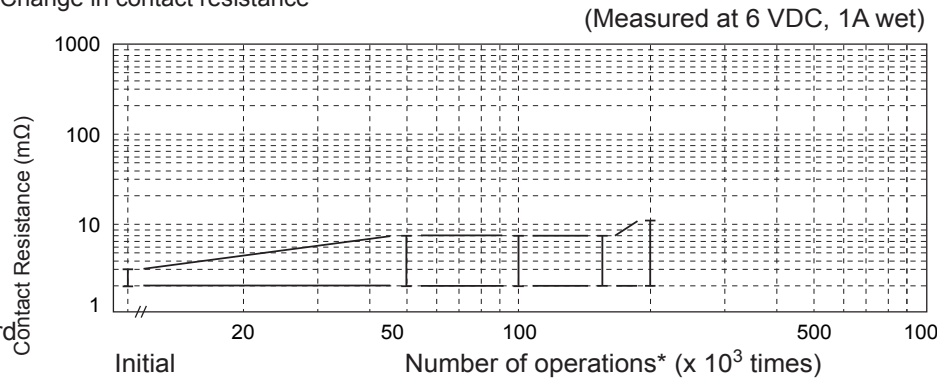

\* 1 operation = 1 forward and 1 reverse

- Test item  
14 V DC,  
inrush current: 17A  
motor free  
300K operations minimum  
0.25 seconds ON,  
9.75 seconds OFF

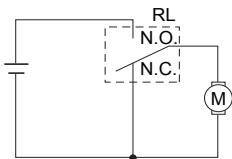

- Change of operate and release voltage

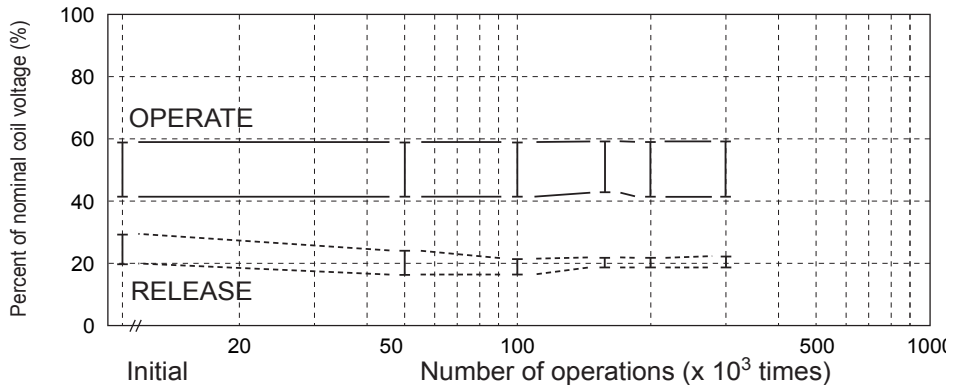

- Current wave form

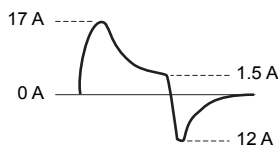

- Change in contact resistance

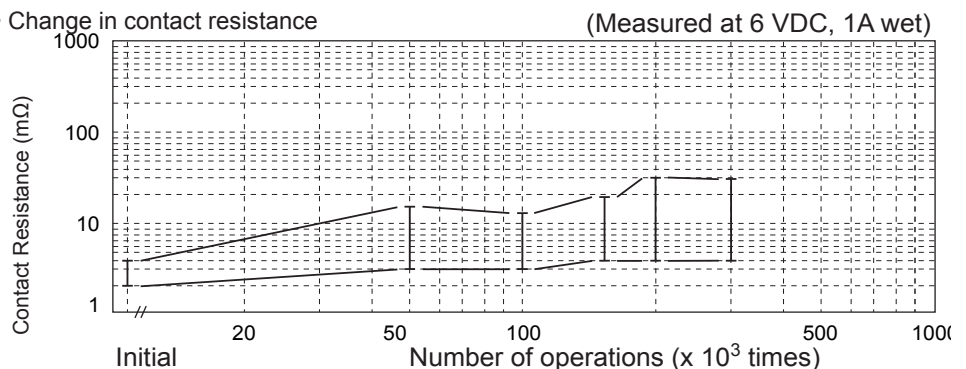

# FTR-P3 SERIES

## 2. MAXIMUM BREAK CAPACITY

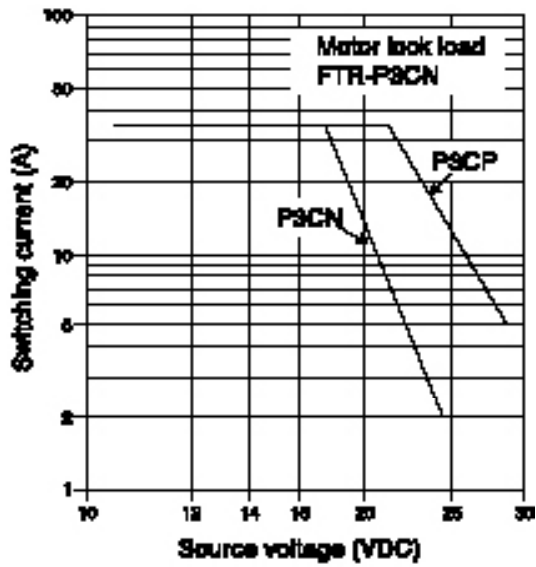

## 3. COIL TEMPERATURE RISE

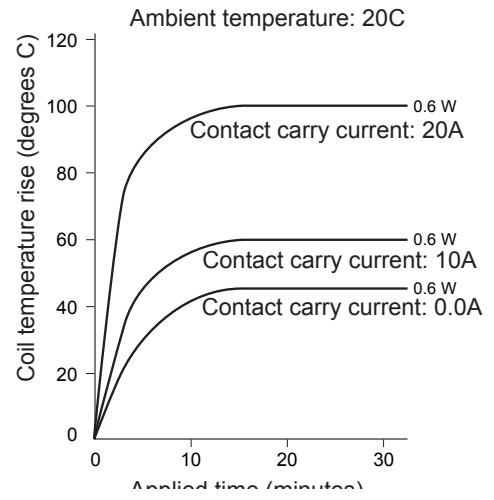

## 4. OPERATING COIL VOLTAGE RANGE

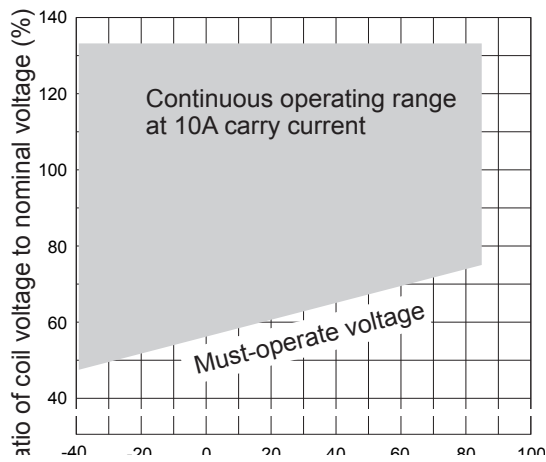

# FTR-P3 SERIES

## 5. VIBRATION RESISTANCE CHARACTERISTIC

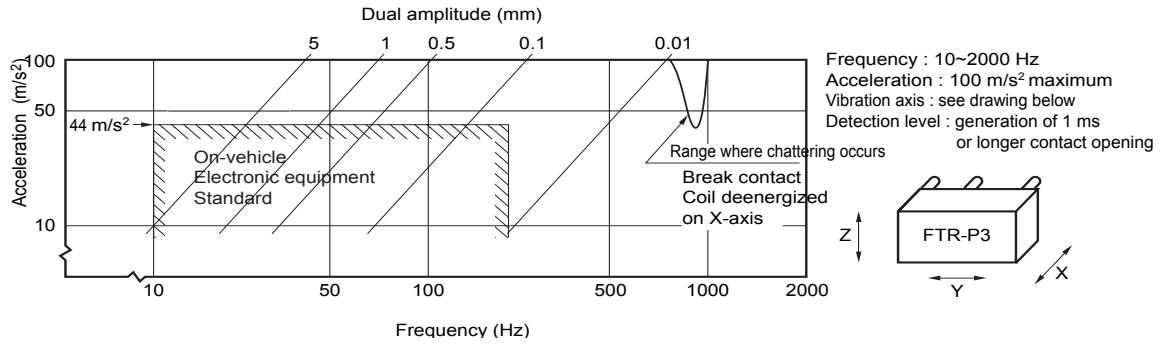

## 6. SHOCK RESISTANCE CHARACTERISTIC

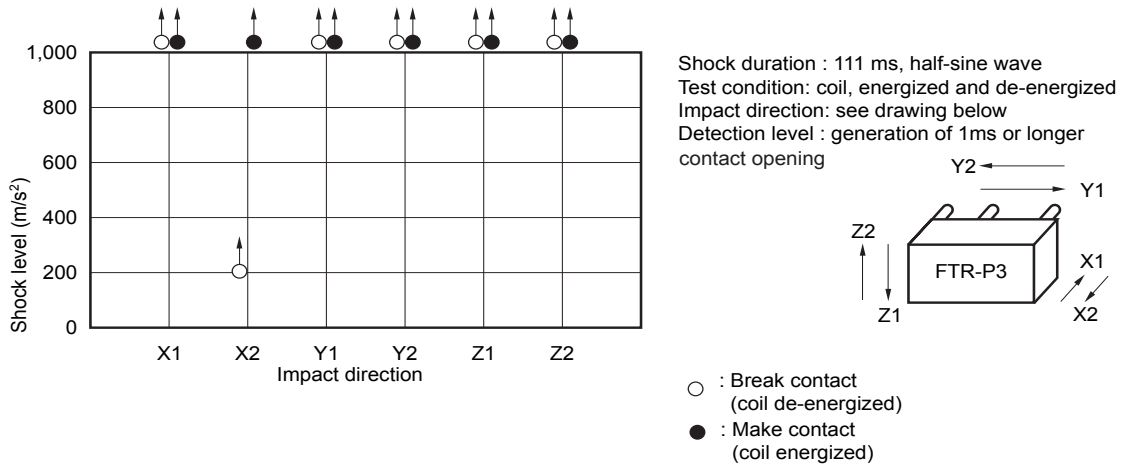

## ■ REFERENCE DATA

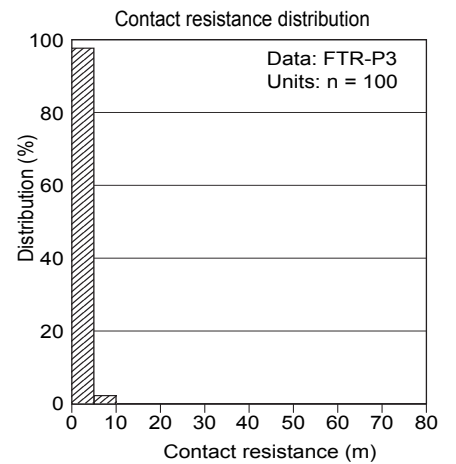
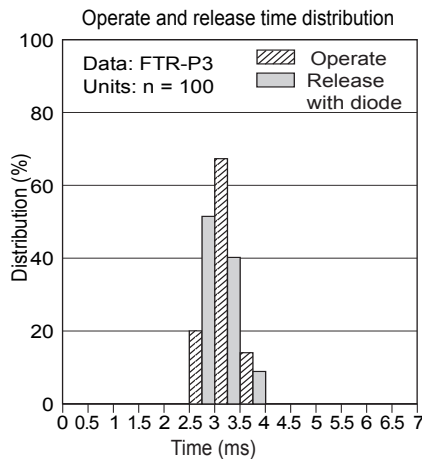
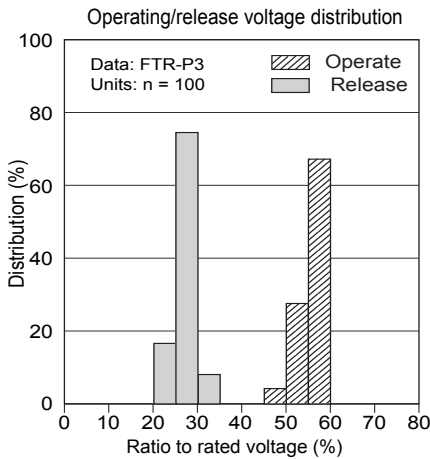

# FTR-P3 SERIES

## ■ DIMENSIONS AND SCHEMATICS

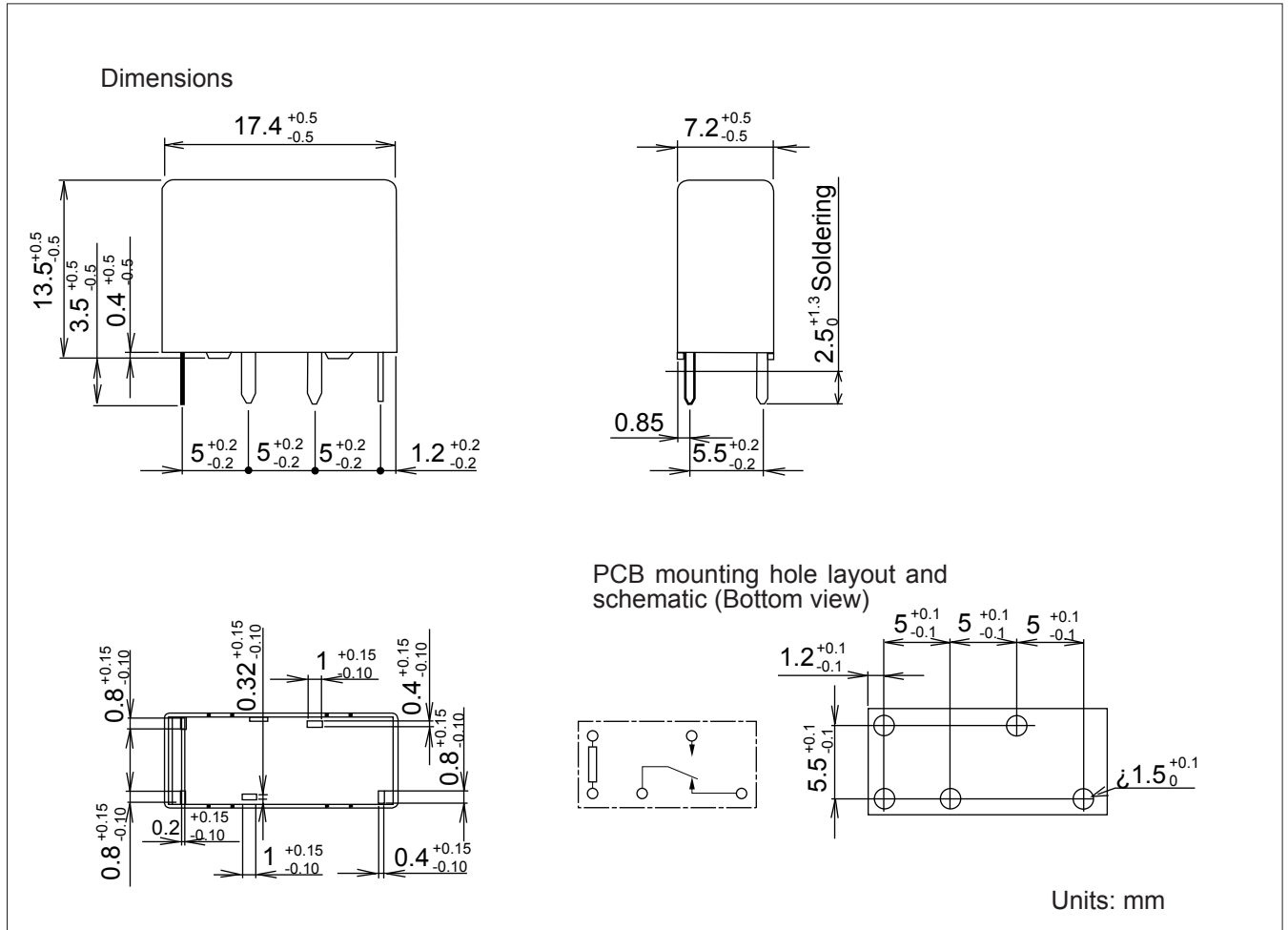

## ■ PRECAUTIONS

Please refer to the Engineering Reference in our relay databook for general precautions.

## RoHS Compliance and Lead Free Relay Information

### 1. General Information

- Relays produced after the specific date code that is indicated on each data sheet are lead-free now. Most of our signal and power relays are lead-free. Please refer to Lead-Free Status Info. (<http://www.fujitsu.com/us/downloads/MICRO/fcai/relays/lead-free-letter.pdf>)
  - Lead free solder paste currently used in relays is Sn-3.0Ag-0.5Cu.
  - All signal and most power relays also comply with RoHS. Please refer to individual data sheets. Relays that are RoHS compliant do not contain the 5 hazardous materials that are restricted by RoHS directive (lead, mercury, chromium IV, PBB, PBDE).
  - It has been verified that using lead-free relays in leaded assembly process will not cause any problems (compatible).
  - "LF" is marked on each outer and inner carton. (No marking on individual relays).
  - To avoid leaded relays (for lead-free sample, etc.) please consult with area sales office.
  - We will ship leaded relays as long as the leaded relay inventory exists.
- Note: Cadmium was exempted from RoHS on October 21, 2005. (Amendment to Directive 2002/95/EC)

### 2. Recommended Lead Free Solder Profile

- Recommended solder paste Sn-3.0Ag-0.5Cu.

#### Reflow Solder condition

**Flow Solder condition:**

Pre-heating: maximum 120°C  
Soldering: dip within 5 sec. at  
260°C solder bath

**Solder by Soldering Iron:**

Soldering Iron  
Temperature: maximum 360°C  
Duration: maximum 3 sec.

**We highly recommend that you confirm your actual solder conditions**

### 3. Moisture Sensitivity

- Moisture Sensitivity Level standard is not applicable to electromechanical relays.

### 4. Tin Whisker

- Dipped SnAgCu solder is known as low risk tin whisker. No considerable length whisker was found by our in house test.



# FTR-P3 SERIES

## Fujitsu Components International Headquarter Offices

### Japan

Fujitsu Component Limited  
Gotanda-Chuo Building  
3-5, Higashigotanda 2-chome, Shinagawa-ku  
Tokyo 141 8630, Japan  
Tel: (81-3) 5449-7010  
Fax: (81-3) 5449-2626  
Email: [promothq@fcl.fujitsu.com](mailto:promothq@fcl.fujitsu.com)  
Web: [www.fcl.fujitsu.com](http://www.fcl.fujitsu.com)

### North and South America

Fujitsu Components America, Inc.  
250 E. Caribbean Drive  
Sunnyvale, CA 94089 U.S.A.  
Tel: (1-408) 745-4900  
Fax: (1-408) 745-4970  
Email: [components@us.fujitsu.com](mailto:components@us.fujitsu.com)  
Web: <http://www.fujitsu.com/us/services/edevice/components/>

### Europe

Fujitsu Components Europe B.V.  
Diamantlaan 25  
2132 WV Hoofddorp  
Netherlands  
Tel: (31-23) 5560910  
Fax: (31-23) 5560950  
Email: [info@fceu.fujitsu.com](mailto:info@fceu.fujitsu.com)  
Web: [emea.fujitsu.com/components/](http://emea.fujitsu.com/components/)

### Asia Pacific

Fujitsu Components Asia Ltd.  
102E Pasir Panjang Road  
#01-01 Citilink Warehouse Complex  
Singapore 118529  
Tel: (65) 6375-8560  
Fax: (65) 6273-3021  
Email: [fcal@fcal.fujitsu.com](mailto:fcal@fcal.fujitsu.com)  
Web: <http://www.fujitsu.com/sg/services/micro/components/>

©2006 Fujitsu Components America, Inc. All rights reserved. All trademarks or registered trademarks are the property of their respective owners.

Fujitsu Components America or its affiliates do not warrant that the content of datasheet is error free. In a continuing effort to improve our products Fujitsu Components America, Inc. or its affiliates reserve the right to change specifications/datasheets without prior notice.  
Rev. July 26/2006