

Am93L412/93L422

256 x 4-Bit Low-Power TTL Bipolar IMOX™ RAM

Am93L412/93L422

3

DISTINCTIVE CHARACTERISTICS

- High-speed
- Internal ECL circuitry for optimum speed/power performance over voltage and temperature
- Output preconditioned during write to eliminate write recovery glitch
- Available with three-state outputs or with open-collector outputs
- Power dissipation decreases with increasing temperature

GENERAL DESCRIPTION

The Am93L412/L422 is comprised of 1024-bit RAMs built using Schottky diode clamped transistors in conjunction with internal ECL circuitry and is ideal for use in high-speed control and buffer memory applications. Each memory is organized as a fully decoded 256-word memory of four bits per word. Easy memory expansion is provided by an active-LOW chip select one (\overline{CS}_1) and active HIGH chip select two (CS_2) as well as open collector OR tieable outputs (Am93L412) or three-state outputs (Am93L422).

An active-LOW write line (\overline{WE}) controls the writing/reading operation of the memory. When the chip select one (\overline{CS}_1) and write line (\overline{WE}) are LOW and chip select two (CS_2) is HIGH, the information on data inputs (D_0 through D_3) is written into the addressed memory word and preconditions

the output circuitry so that true data is present at the outputs when the write cycle is complete. This preconditioning operation insures minimum write recovery times by eliminating the "write recovery glitch."

Reading is performed with the chip select one (\overline{CS}_1) LOW and the chip select two (CS_2) HIGH and the write line (\overline{WE}) HIGH and with the output enable (\overline{OE}) LOW. The information stored in the addressed word is read out on the noninverting outputs (O_0 through O_3).

The outputs of the memory go to an inactive high-impedance state whenever chip select one (\overline{CS}_1) is HIGH, chip select two (CS_2) is LOW, output enable (\overline{OE}) is HIGH, or during the writing operation when write enable (\overline{WE}) is LOW.

BLOCK DIAGRAM

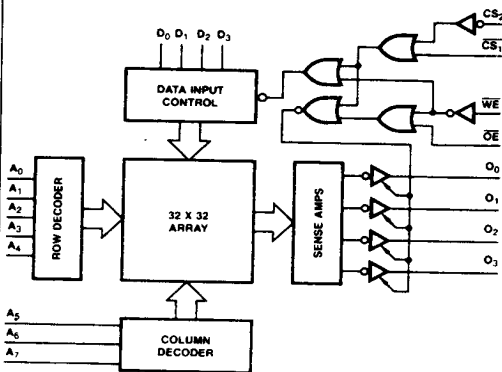

MODE SELECT TABLE

Input					Output		Mode
CS_2	\overline{CS}_1	\overline{WE}	\overline{OE}	D_n	O_n		
L	X	X	X	X	*Hi-Z	Not Select	
X	H	X	X	X	*Hi-Z	Not Select	
H	L	H	H	X	*Hi-Z	Output Disable	
H	L	H	L	X	Selected Data	Read Data	
H	L	L	X	L	*Hi-Z	Write "0"	
H	L	L	X	H	*Hi-Z	Write "1"	
H	L	L	H	L	Hi-Z	Write "0" Output Disable	
H	L	L	H	H	Hi-Z	Write "1" Output Disable	

H = HIGH L = LOW X = Don't Care
 *Hi-Z implies outputs are disabled or off. This condition is defined as a high-impedance state for the Am93L422A/L422 and as output high level for the Am93L412A/L412.

BD000600

PRODUCT SELECTOR GUIDE

Open-Collector Part Number	Am93L412A	Am93L412A	Am93L412	Am93L412
Three-State Part Number	Am93L422A	Am93L422A	Am93L422	Am93L422
Access Time	45 ns	55 ns	60 ns	75 ns
Temperature Range	C	M	C	M

IMOX is a trademark of Advanced Micro Devices, Inc.

Publication # 08015	Rev. A	Amendment 70
Issue Date: May 1986		

CONNECTION DIAGRAMS Top View

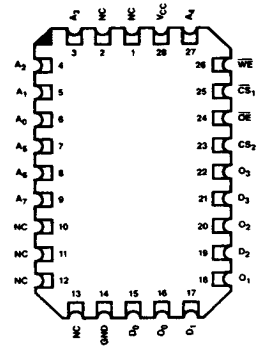
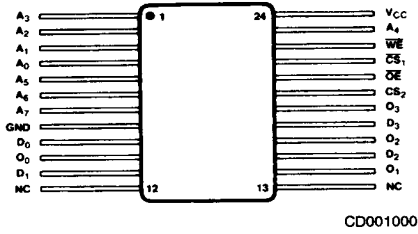
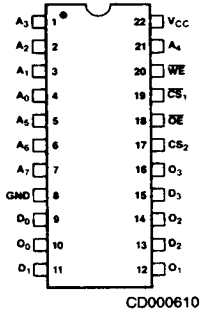

Note: Pin 1 is marked for orientation.

LOGIC SYMBOL

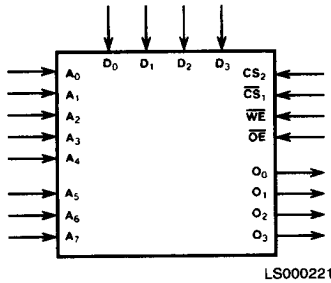

ORDERING INFORMATION (Cont'd.)

Standard Products

AMD standard products are available in several packages and operating ranges. The order number (Valid Combination) is formed by a combination of:

- A. Device Number**
- B. Speed Option** (if applicable)
- C. Package Type**
- D. Temperature Range**
- E. Optional Processing**

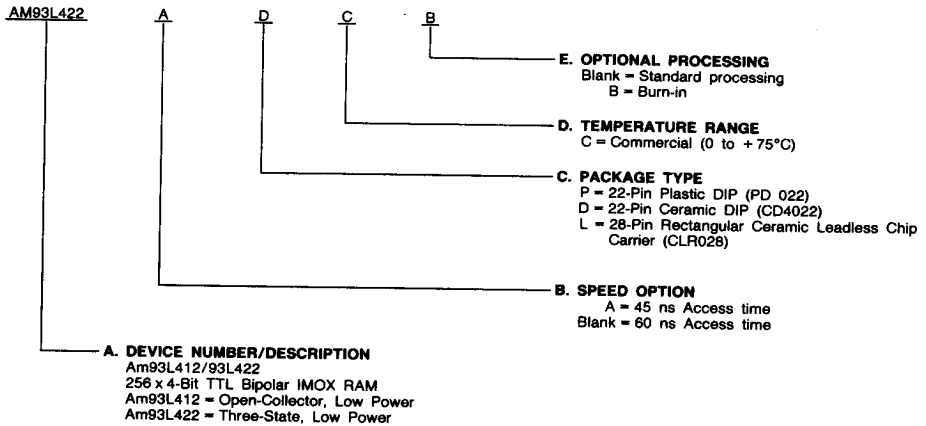

Valid Combinations	
AM93L422	
AM93L422A	PC, PCB,
AM93L412	DC, DCB,
AM93L412A	LC, LCB

Valid Combinations

Valid Combinations list configurations planned to be supported in volume for this device. Consult the local AMD sales office to confirm availability of specific valid combinations, to check on newly released combinations, and to obtain additional data on AMD's standard military grade products.

ORDERING INFORMATION

CPL Products

AMD products for Aerospace and Defense applications are available in several packages and operating ranges. APL (Approved Products List) products are fully compliant with MIL-STD-883C requirements. CPL (Controlled Products List) products are processed in accordance with MIL-STD-883C, but are inherently non-compliant because of package, solderability, or surface treatment exceptions to those specifications. The order number (Valid Combination) for CPL products is formed by a combination of:

- A. Device Number**
- B. Speed Option** (if applicable)
- C. Device Class**
- D. Package Type**
- E. Lead Finish**

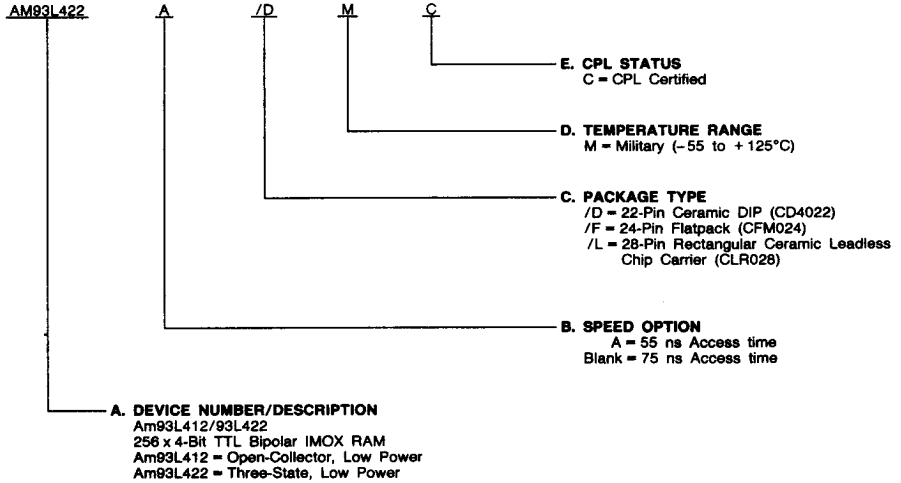

Valid Combinations	
AM93L422	/DMC, /FMC, /LMC
AM93L422A	
AM93L412	
AM93L412A	

Valid Combinations

Valid Combinations list configurations planned to be supported in volume for this device. Consult the local AMD sales office to confirm availability of specific valid combinations or to check for newly released valid combinations.

ABSOLUTE MAXIMUM RATINGS

Storage Temperature	-65 to +150°C
Ambient Temperature with Power Applied	-55 to +125°C
Supply Voltage	-0.5 V to +7.0 V
DC Voltage Applied to Outputs	-0.5 V to +V _{CC} Max.
DC Input Voltage	-0.5 V to +5.5 V
DC Input Current	-30 mA to +5 mA

Stresses above those listed under ABSOLUTE MAXIMUM RATINGS may cause permanent device failure. Functionality at or above these limits is not implied. Exposure to absolute maximum ratings for extended periods may affect device reliability.

OPERATING RANGES

Commercial (C) Devices	
Temperature	0 to +75°C
Supply Voltage	+4.75 V to +5.25 V
Military (M) Devices	
Temperature	-55 to +125°C
Supply Voltage	+4.5 V to +5.5 V

Operating ranges define those limits between which the functionality of the device is guaranteed.

DC CHARACTERISTICS over operating range unless otherwise specified*

Parameter Symbol	Parameter Description	Test Conditions		Min.	Typ (Note 1)	Max.	Units
V _{OH} (Note 2)	Output HIGH Voltage	V _{CC} = Min., V _{IN} = V _{IH} or V _{IL}	I _{OH} = -5.2 mA	2.4	3.6		Volts
V _{OL}	Output LOW Voltage	V _{CC} = Min., V _{IN} = V _{IH} or V _{IL}	I _{OL} = 8.0 mA		0.350	0.45	Volts
V _{IH}	Input HIGH Level (Note 3)	Guaranteed input logical HIGH voltage for all inputs		2.1			Volts
V _{IL}	Input LOW Level (Note 3)	Guaranteed input logical LOW voltage for all inputs				0.8	Volts
I _{IL}	Input LOW Current	V _{CC} = Max., V _{IN} = 0.40 V			-100	-300	μA
I _{IH}	Input HIGH Current	V _{CC} = Max., V _{IN} = 4.5 V			1	40	μA
I _{SC} (Note 2)	Output Short Circuit Current	V _{CC} = Max., V _{OUT} = 0.0 V (Note 4)		-10		-90	mA
I _{CC}	Power Supply Current	ALL inputs = GND V _{CC} = Max.	Commercial			80	mA
			Military			90	mA
V _{CL}	Input Clamp Voltage	V _{CC} = Min., I _{IN} = -10 mA			-0.850	-1.5	Volts
I _{CEX}	Output Leakage Current	V _{OUT} = 2.4 V	Am93L422A/L422		0	50	μA
		V _{OUT} = 0.5 V, V _{CC} = Max.	Am93L422A/L422	-50	0		
		V _{OUT} = 4.5 V	Am93L412A/L412		0	100	
C _{IN}	Input Pin Capacitance	See Note 5			4		pF
C _{OUT}	Output Pin Capacitance	See Note 5			7		pF

- Notes: 1. Typical limits are at V_{CC} = 5.0 V and T_A = 25°C.
 2. Applies only to devices with three-state outputs (Am93L422 family).
 3. These are absolute voltages with respect to device ground pin and include all overshoots due to system and/or tester noise. Do not attempt to test these values without suitable equipment.
 4. Not more than one output should be shorted at a time. Duration of the short circuit should not be more than one second.
 5. Input and output capacitance measured on a sample basis @ f = 1.0 MHz at initial characterization.
 6. Operating specification with adequate time for temperature stabilization and transverse air flow exceeding 400 linear feet per minute. Conformance testing performed instantaneously where T_A = T_C = T_j.
 θ_JA ≥ 66°C/W (with moving air) for Ceramic DIP.
 θ_JC ≥ 18°C/W for Flatpack and Leadless Chip Carrier.

*See the last page of this spec for Group A Subgroup testing information.

SWITCHING TEST CIRCUIT

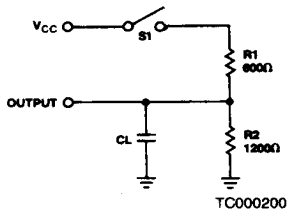

SWITCHING TEST WAVEFORMS

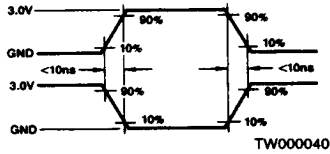

KEY TO SWITCHING WAVEFORMS

WAVEFORM	INPUTS	OUTPUTS
	MUST BE STEADY	WILL BE STEADY
	MAY CHANGE FROM H TO L	WILL BE CHANGING FROM H TO L
	MAY CHANGE FROM L TO H	WILL BE CHANGING FROM L TO H
	DON'T CARE; ANY CHANGE PERMITTED	CHANGING; STATE UNKNOWN
	DOES NOT APPLY	CENTER LINE IS HIGH IMPEDANCE "OFF" STATE

KS000010

*See notes after Switching Characteristics.

SWITCHING CHARACTERISTICS over operating range unless otherwise specified*

No.	Parameter Symbol	Parameter Description	Am93L412A/L422A				Am93L412/L422				Units
			C devices		M devices		C devices		M devices		
			Min.	Max.	Min.	Max.	Min.	Max.	Min.	Max.	
1	$t_{PLH}(A)$ (Note 2)	Delay from Address to Output		45		55		60		75	ns
2	$t_{PHL}(A)$ (Note 2)	(Address Access Time)									
3	$t_{PZH}(\overline{CS}_1, CS_2)$	Delay from Chip Select to Active Output and Correct Data		30		40		35		45	ns
4	$t_{PZL}(\overline{CS}_1, CS_2)$										
5	$t_{PZH}(\overline{WE})$	Delay from Write Enable to Active Output and Correct Data		40		45		45		50	ns
6	$t_{PZL}(\overline{WE})$	(Write Recovery)									
7	$t_{PZH}(\overline{OE})$	Delay from Output Enable to Active Output and Correct Data		30		40		35		45	ns
8	$t_{PZL}(\overline{OE})$										
9	$t_s(A)$	Setup Time Address (Prior to Initiation of Write)	5		10		10		10		ns
10	$t_h(A)$	Hold Time Address (After Termination of Write)	5		5		5		10		ns
11	$t_s(DI)$	Setup Time Data Input (Prior to Initiation of Write)	5		5		5		5		ns
12	$t_h(DI)$	Hold Time Data Input (After Termination of Write)	5		5		5		5		ns
13	$t_s(\overline{CS}_1, CS_2)$	Setup Time Chip Select (Prior to Initiation of Write)	5		5		5		5		ns
14	$t_h(\overline{CS}_1, CS_2)$	Hold Time Chip Select (After Termination of Write)	5		5		5		10		ns
15	$t_{pw}(\overline{WE})$	Min Write Enable Pulse Width to Insure Write	35		40		45		55		ns
16	$t_{PHZ}(\overline{CS}_1, CS_2)$	Delay from Chip Select to Inactive Output (Hi-Z)		30		40		35		45	ns
17	$t_{PLZ}(\overline{CS}_1, CS_2)$										
18	$t_{PHZ}(\overline{WE})$	Delay from Write Enable to Inactive Output (Hi-Z)		35		40		40		45	ns
19	$t_{PLZ}(\overline{WE})$										
20	$t_{PHZ}(\overline{OE})$	Delay from Output Enable to Inactive Output (Hi-Z)		30		40		35		45	ns
21	$t_{PLZ}(\overline{OE})$										

Notes: 1. For AC and Functional Testing, $V_{IH} = 3.0\text{ V}$ and $V_{IL} = 0.0\text{ V}$.

2. $t_{PLH}(A)$ and $t_{PHL}(A)$ are tested with S_1 closed and $C_L = 30\text{ pF}$ with both input and output timing referenced to 1.5 V.

3. For open collector devices, all delays from Write Enable (\overline{WE}) or selects (\overline{CS}_1 , CS_2 , \overline{OE}) inputs to the Data Output ($O_0 - O_3$) ($t_{PLZ}(\overline{WE})$, $t_{PLZ}(\overline{CS}_1, CS_2)$, $t_{PLZ}(\overline{OE})$, $t_{PZL}(\overline{WE})$, $t_{PZL}(\overline{CS}_1, CS_2)$ and $t_{PZL}(\overline{OE})$) are measured with S_1 closed and $C_L = 30\text{ pF}$; and with both the input and output timing referenced to 1.5 V.

4. For three-state output devices, $t_{PZH}(\overline{WE})$, $t_{PZH}(\overline{CS}_1, CS_2)$ and $t_{PZH}(\overline{OE})$ are measured with S_1 open, $C_L = 30\text{ pF}$ and with both the input and output timing referenced to 1.5 V. $t_{PZL}(\overline{WE})$, $t_{PZL}(\overline{CS}_1, CS_2)$ and $t_{PZL}(\overline{OE})$ are measured with S_1 closed, $C_L = 30\text{ pF}$ and with both the input and output timing referenced to 1.5 V. $t_{PHZ}(\overline{WE})$, $t_{PHZ}(\overline{CS}_1, CS_2)$ and $t_{PHZ}(\overline{OE})$ are measured with S_1 open and $C_L \leq 5\text{ pF}$ and are measured between the 1.5 V level on the input to the $V_{OH} - 500\text{ mV}$ level on the output. $t_{PLZ}(\overline{WE})$, $t_{PLZ}(\overline{CS}_1, CS_2)$ and $t_{PLZ}(\overline{OE})$ are measured with S_1 closed and $C_L \leq 5\text{ pF}$ and are measured between the 1.5 V level on the input and the $V_{OL} + 500\text{ mV}$ level on the output.

*See the last page of this spec for Group A Subgroup testing information.

3

SWITCHING WAVEFORMS

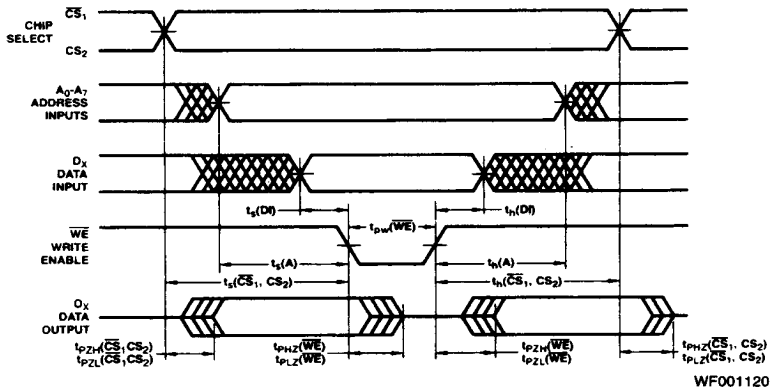

Diagram A. Write Mode (With $\overline{OE} = \text{LOW}$)

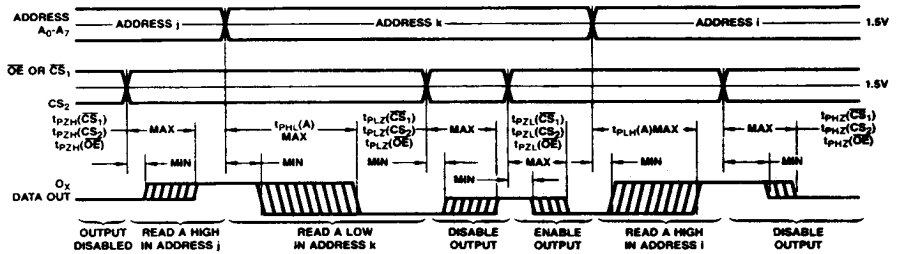

Diagram B. Read Mode

Switching delays form address input, output enable input and the chip select inputs to the data output. For the Am93422A/422 disabled output is OFF, represented by a single center line. For the Am93L412A/412, a disabled output is HIGH.

GROUP A SUBGROUP TESTING

DC CHARACTERISTICS

Parameter Symbol	Subgroups
V _{OH}	1, 2, 3
V _{OL}	1, 2, 3
V _{IH}	1, 2, 3
V _{IL}	1, 2, 3
I _{IL}	1, 2, 3
I _{IH}	1, 2, 3
I _{SC}	1, 2, 3
I _{CC}	1, 2, 3
V _{CL}	1, 2, 3
I _{CEX}	1, 2, 3

SWITCHING CHARACTERISTICS

No.	Parameter Symbol	Subgroups	No.	Parameter Symbol	Subgroups
1	t _{PLH} (A)	9, 10, 11	12	t _H (DI)	9, 10, 11
2	t _{PHL} (A)	9, 10, 11	13	t _S ($\overline{CS_1}$, CS ₂)	9, 10, 11
3	t _{PZH} ($\overline{CS_1}$, CS ₂)	9, 10, 11	14	t _H ($\overline{CS_1}$, CS ₂)	9, 10, 11
4	t _{PZL} ($\overline{CS_1}$, CS ₂)	9, 10, 11	15	t _{PW} (WE1)	9, 10, 11
5	t _{PZH} (WE)	9, 10, 11	16	t _{PHZ} ($\overline{CS_1}$, CS ₂)	9, 10, 11
6	t _{PZL} (WE)	9, 10, 11	17	t _{PLZ} ($\overline{CS_1}$, CS ₂)	9, 10, 11
7	t _{PZH} (OE)	9, 10, 11	18	t _{PHZ} (WE)	9, 10, 11
8	t _{PZL} (OE)	9, 10, 11	19	t _{PLZ} (WE)	9, 10, 11
9	t _S (A)	9, 10, 11	20	t _{PHZ} (OE)	9, 10, 11
10	t _H (A)	9, 10, 11	21	t _{PLZ} (OE)	9, 10, 11
11	t _S (DI)	9, 10, 11			

MILITARY BURN-IN

Military burn-in is in accordance with the current revisions of MIL-STD-883, Test Method 1015, Conditions A through E. Test conditions are selected at AMD's option.