

PTS635 Series 3,5 mm Tact Switches



Features/Benefits

- Compact size 6 x 3.5 mm
- Variety of switch heights
- Choice of actuation force
- RoHS compliant and compatible

Typical Applications

- Consumer products
- Instrumentation
- Computer products
- Industrial

B

Tactile Switches

Specification

FUNCTION: Momentary action
CONTACT ARRANGEMENT: SPST, N.O.
TERMINALS: PC pins

Mechanical

ACTUATION FORCE: PTS635L models: 130 grams.
PTS635H models: 200 grams.
LIFE EXPECTANCY: 20,000 operations.

Electrical

CONTACT RATING: 50 mA @ 12 V DC.
DIELECTRIC STRENGTH: 250 V AC min.
CONTACT RESISTANCE: 100 mΩ max. initial.
INSULATION RESISTANCE: 10¹¹ Ω min.

Environmental

OPERATING TEMPERATURE: -40°C to 60°C

NOTE: Specifications listed above are for switches with standard options.
For information on specific and custom switches, consult Customer Service Center.

Process

SOLDERING: Preheating to 100°C for 45 sec. max. Keep flux flush with top surface of PCB; do not apply to component side of PCB and area where terminals are located. Soldering to 255°C for 5 sec. max. Clean by brushing on solder surface. Do not clean switch with solvents.

Materials

BASE: 6/6 nylon or glass filled polyester (PBT) (UL 94V-0).
ACTUATOR: 6/6 nylon or polyacetal (UL 94HB).
COVER PLATE: PTS635S and PTS635V models: Tin plated stainless steel
DOME CONTACTS: Phosphor bronze, silver clad.
STATIONARY CONTACTS: Brass, silver plated.
TERMINALS: Brass, silver plated. Insert molded.

Packaging

Bulk packaging.

Tape & reel for:

PTS635Sx43SMTR, 1700 pcs per reel
PTS635Sx25SMTR, 3000 pcs per reel

How To Order

Our easy build-a-switch concept allows you to mix and match options to create the switch you need. To order, select desired option from each category and place it in the appropriate box.

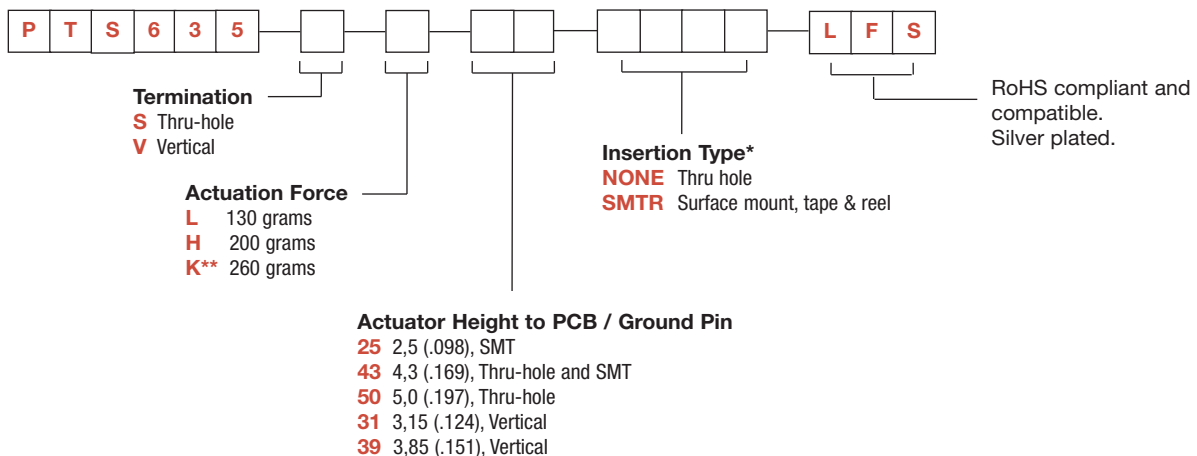

* SM and SMTR only available with PTS635 43 and 25 actuator options.

** Only for the PTS635Sx25SMTR.

PTS635 Series 3,5 mm Tact Switches

SERIES

PTS635

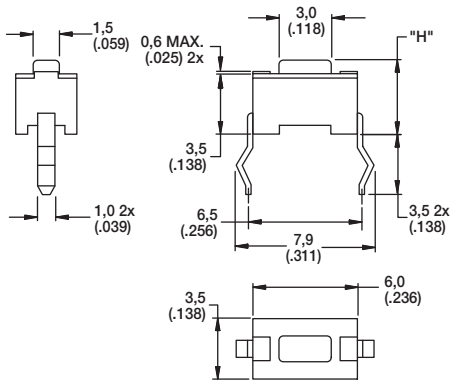

PTS635S Model

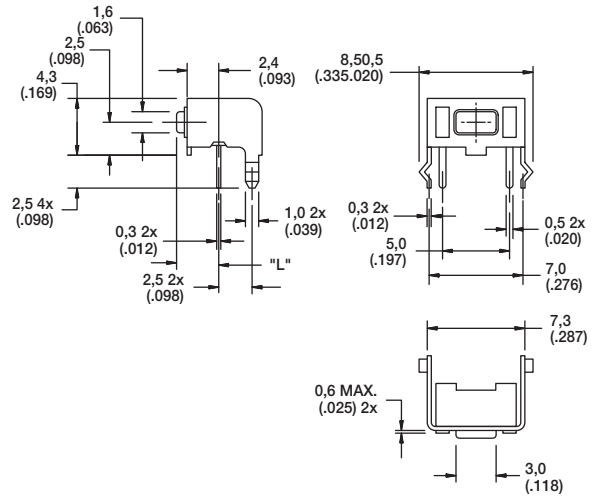

B

Tactile Switches

TERMINATION

S THRU-HOLE

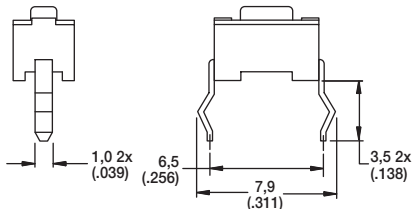

PCB LAYOUT

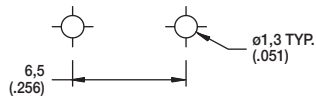

V VERTICAL

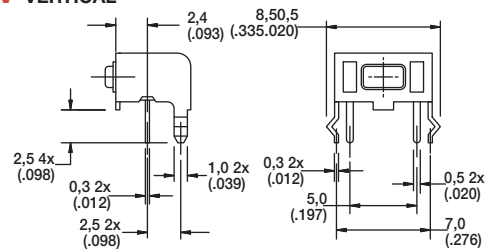

PCB LAYOUT

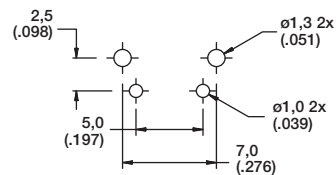

SMT 25

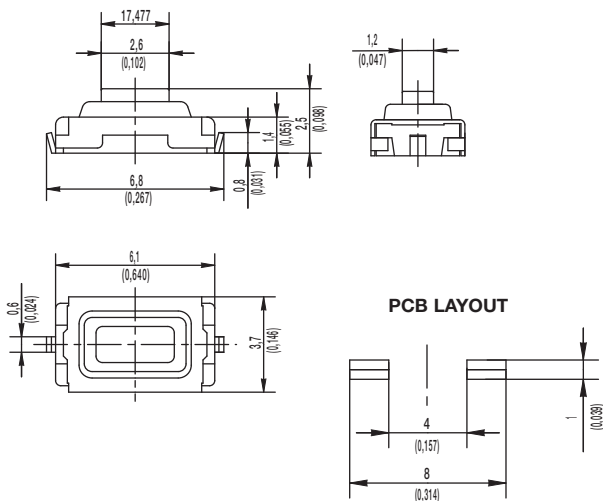

PCB LAYOUT

SMT 43

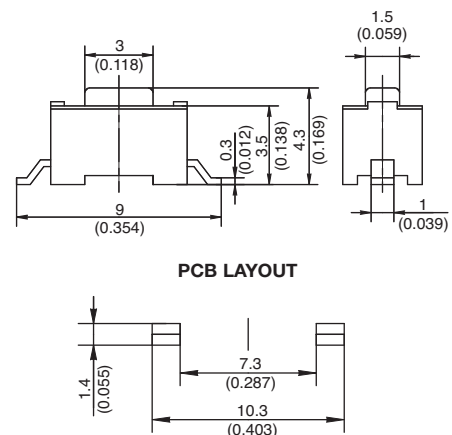

PCB LAYOUT



First Angle
Projection

Dimensions are shown: Inch (mm)
Specifications and dimensions subject to change







PTS635 Series 3,5 mm Tact Switches

ACTUATION FORCE

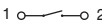
OPTION CODE	FORCE
L	130 grams
H	200 grams

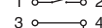
ACTUATOR HEIGHT

OPTION CODE	HEIGHT "H" or LENGTH "L"	TERMINATION	SCHEMATIC
43	4,3 (.169)	Thru-hole	1  2
50	5,0 (.197)	Thru-hole	1  2
31	3,15 (.124)	Vertical	1  2
39	3,85 (.151)	Vertical	3  4

INSERTION TYPE

SMT 25

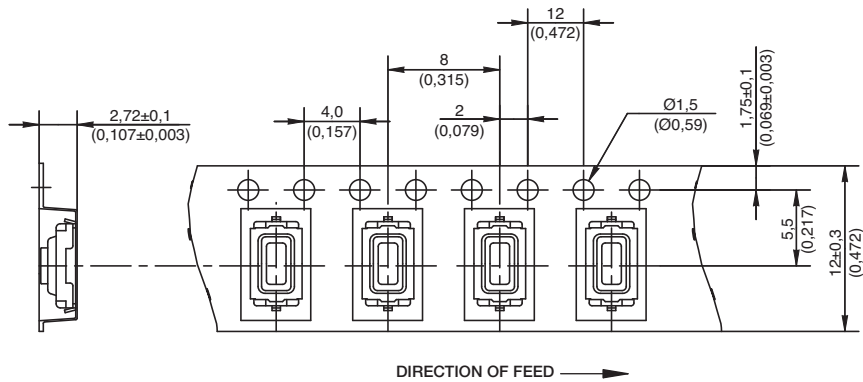

SMT 43

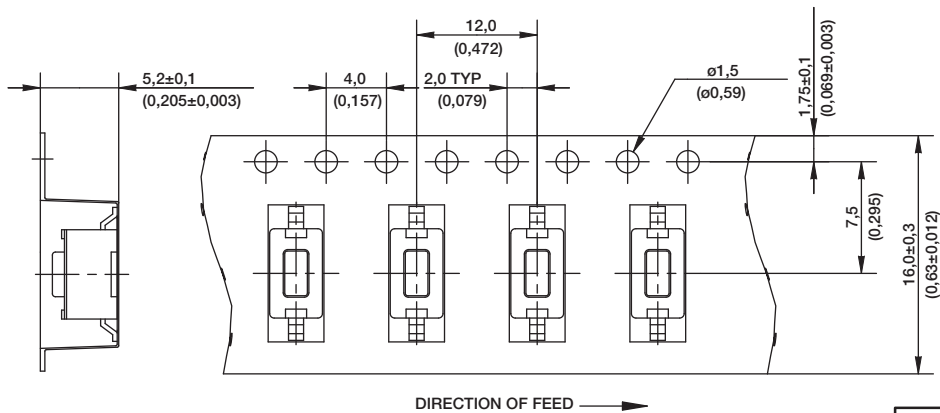

Dimensions are shown: Inch (mm)
Specifications and dimensions subject to change