



# LPC2109/2119/2129

Single-chip 16/32-bit microcontrollers; 64/128/256 kB ISP/IAP flash with 10-bit ADC and CAN

Rev. 06 — 10 December 2007

Product data sheet

## 1. General description

The LPC2109/2119/2129 are based on a 16/32-bit ARM7TDMI-S CPU with real-time emulation and embedded trace support, together with 64/128/256 kB of embedded high-speed flash memory. A 128-bit wide memory interface and a unique accelerator architecture enable 32-bit code execution at maximum clock rate. For critical code size applications, the alternative 16-bit Thumb mode reduces code by more than 30 % with minimal performance penalty.

With their compact 64-pin package, low power consumption, various 32-bit timers, 4-channel 10-bit ADC, two advanced CAN channels, PWM channels and 46 fast GPIO lines with up to nine external interrupt pins these microcontrollers are particularly suitable for automotive and industrial control applications, as well as medical systems and fault-tolerant maintenance buses. With a wide range of additional serial communications interfaces, they are also suited for communication gateways and protocol converters as well as many other general-purpose applications.

**Remark:** Throughout the data sheet, the term LPC2109/2119/2129 will apply to devices with and without the /00 or /01 suffixes. The /00 or the /01 suffix will be used to differentiate from other devices only when necessary.

## 2. Features

### 2.1 Key features brought by LPC2109/2119/2129/01 devices

- Fast GPIO ports enable port pin toggling up to 3.5 times faster than the original device. They also allow for a port pin to be read at any time regardless of its function.
- Dedicated result registers for ADC(s) reduce interrupt overhead. The ADC pads are 5 V tolerant when configured for digital I/O function(s).
- UART0/1 include fractional baud rate generator, auto-bauding capabilities and handshake flow-control fully implemented in hardware.
- Buffered SSP serial controller supporting SPI, 4-wire SSI, and Microwire formats.
- SPI programmable data length and master mode enhancement.
- Diversified Code Read Protection (CRP) enables different security levels to be implemented. This feature is available in LPC2109/2119/2129/00 devices as well.
- General purpose timers can operate as external event counters.

### 2.2 Key features common for all devices

- 16/32-bit ARM7TDMI-S microcontroller in a tiny LQFP64 package.
- 8/16 kB on-chip static RAM.



- 64/128/256 kB on-chip flash program memory. 128-bit wide interface/accelerator enables high speed 60 MHz operation.
- In-System Programming (ISP) and In-Application Programming (IAP) via on-chip bootloader software. Flash programming takes 1 ms per 512 B line. Single sector or full chip erase takes 400 ms.
- EmbeddedICE-RT interface enables breakpoints and watch points. Interrupt service routines can continue to execute while the foreground task is debugged with the on-chip RealMonitor software.
- Embedded Trace Macrocell (ETM) enables non-intrusive high speed real-time tracing of instruction execution.
- Two interconnected CAN interfaces (one for LPC2109) with advanced acceptance filters.
- Four-channel 10-bit A/D converter with conversion time as low as 2.44  $\mu$ s.
- Multiple serial interfaces including two UARTs (16C550), Fast I<sup>2</sup>C-bus (400 kbit/s) and two SPIs.
- 60 MHz maximum CPU clock available from programmable on-chip Phase-Locked Loop with settling time of 100  $\mu$ s.
- Vectored Interrupt Controller with configurable priorities and vector addresses.
- Two 32-bit timers (with four capture and four compare channels), PWM unit (six outputs), Real-Time Clock (RTC) and watchdog.
- Up to forty-six 5 V tolerant general purpose I/O pins. Up to nine edge or level sensitive external interrupt pins available.
- On-chip crystal oscillator with an operating range of 1 MHz to 30 MHz.
- Two low power modes, Idle and Power-down.
- Processor wake-up from Power-down mode via external interrupt.
- Individual enable/disable of peripheral functions for power optimization.
- Dual power supply:
  - ◆ CPU operating voltage range of 1.65 V to 1.95 V (1.8 V  $\pm$  0.15 V).
  - ◆ I/O power supply range of 3.0 V to 3.6 V (3.3 V  $\pm$  10 %) with 5 V tolerant I/O pads.

### 3. Ordering information

Table 1. Ordering information

Type number	Package		Version
	Name	Description	
LPC2109FBD64/00	LQFP64	plastic low profile quad flat package; 64 leads; body 10 $\times$ 10 $\times$ 1.4 mm	SOT314-2
LPC2109FBD64/01	LQFP64	plastic low profile quad flat package; 64 leads; body 10 $\times$ 10 $\times$ 1.4 mm	SOT314-2
LPC2119FBD64	LQFP64	plastic low profile quad flat package; 64 leads; body 10 $\times$ 10 $\times$ 1.4 mm	SOT314-2
LPC2119FBD64/00	LQFP64	plastic low profile quad flat package; 64 leads; body 10 $\times$ 10 $\times$ 1.4 mm	SOT314-2
LPC2119FBD64/01	LQFP64	plastic low profile quad flat package; 64 leads; body 10 $\times$ 10 $\times$ 1.4 mm	SOT314-2

Table 1. Ordering information ...continued

Type number	Package		
	Name	Description	Version
LPC2129FBD64	LQFP64	plastic low profile quad flat package; 64 leads; body 10 × 10 × 1.4 mm	SOT314-2
LPC2129FBD64/00	LQFP64	plastic low profile quad flat package; 64 leads; body 10 × 10 × 1.4 mm	SOT314-2
LPC2129FBD64/01	LQFP64	plastic low profile quad flat package; 64 leads; body 10 × 10 × 1.4 mm	SOT314-2

### 3.1 Ordering options

Table 2. Ordering options

Type number	Flash memory	RAM	CAN	Fast GPIO/ SSP/ Enhanced UART, ADC, Timer	Temperature range
LPC2109FBD64/00	64 kB	8 kB	1 channel	no	−40 °C to +85 °C
LPC2109FBD64/01	64 kB	8 kB	1 channel	yes	−40 °C to +85 °C
LPC2119FBD64	128 kB	16 kB	2 channels	no	−40 °C to +85 °C
LPC2119FBD64/00	128 kB	16 kB	2 channels	no	−40 °C to +85 °C
LPC2119FBD64/01	128 kB	16 kB	2 channels	yes	−40 °C to +85 °C
LPC2129FBD64	256 kB	16 kB	2 channels	no	−40 °C to +85 °C
LPC2129FBD64/00	256 kB	16 kB	2 channels	no	−40 °C to +85 °C
LPC2129FBD64/01	256 kB	16 kB	2 channels	yes	−40 °C to +85 °C

## 4. Block diagram

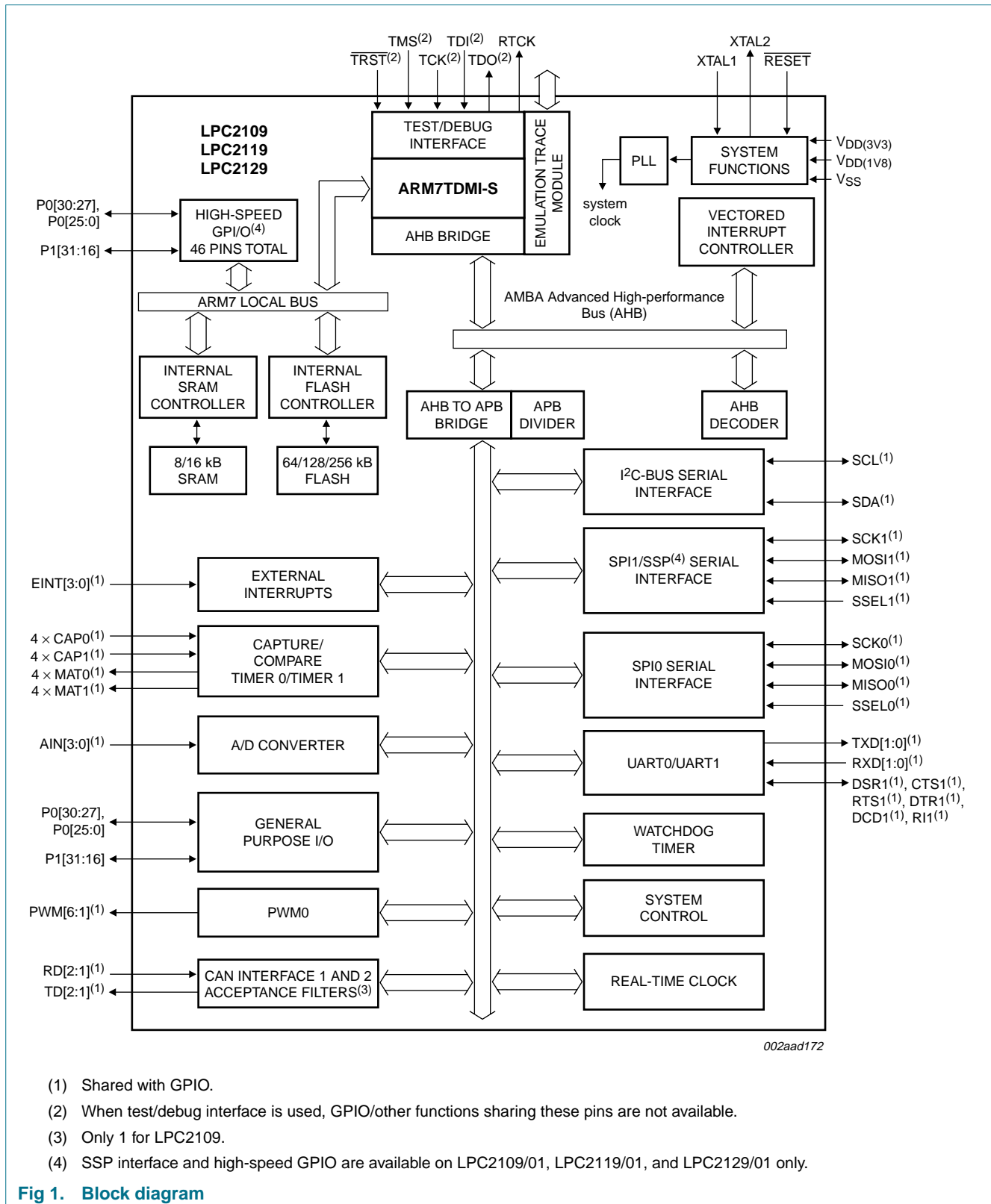

## 5. Pinning information

### 5.1 Pinning

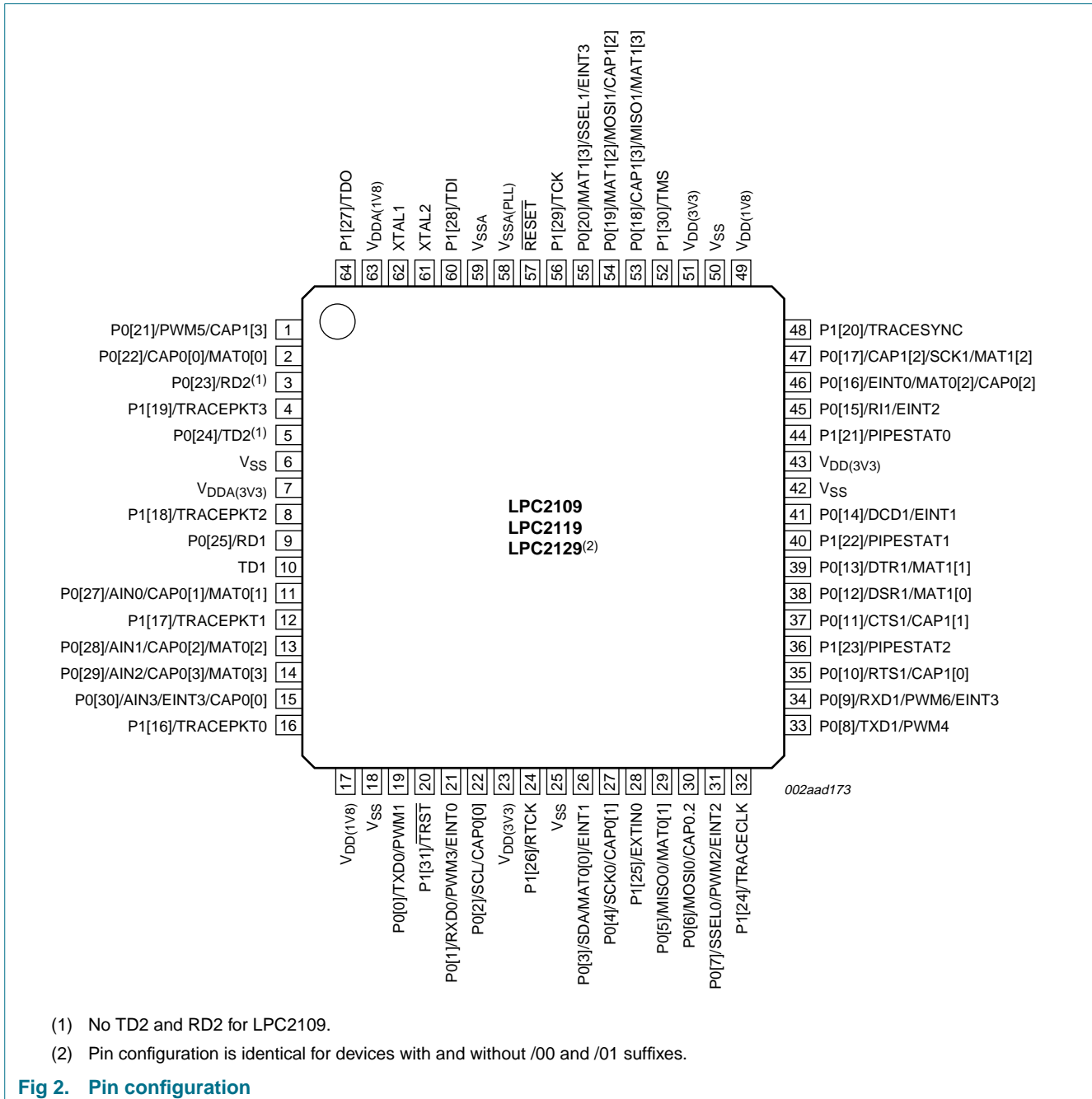

## 5.2 Pin description

**Table 3. Pin description**

Symbol	Pin	Type	Description
P0[0] to P0[31]		I/O	Port 0 is a 32-bit bidirectional I/O port with individual direction controls for each bit. The operation of port 0 pins depends upon the pin function selected via the Pin Connect Block. Pins 26 and 31 of port 0 are not available.
P0[0]/TXD0/ PWM1	19	O	<b>TXD0</b> — Transmitter output for UART0.
		O	<b>PWM1</b> — Pulse Width Modulator output 1.
P0[1]/RXD0/ PWM3/EINT0	21	I	<b>RXD0</b> — Receiver input for UART0.
		O	<b>PWM3</b> — Pulse Width Modulator output 3.
		I	<b>EINT0</b> — External interrupt 0 input
P0[2]/SCL/ CAP0[0]	22	I/O	<b>SCL</b> — I <sup>2</sup> C-bus clock input/output. Open-drain output (for I <sup>2</sup> C-bus compliance).
		I	<b>CAP0[0]</b> — Capture input for Timer 0, channel 0.
P0[3]/SDA/ MAT0[0]/EINT1	26	I/O	<b>SDA</b> — I <sup>2</sup> C-bus data input/output. Open-drain output (for I <sup>2</sup> C-bus compliance).
		O	<b>MAT0[0]</b> — Match output for Timer 0, channel 0.
		I	<b>EINT1</b> — External interrupt 1 input.
P0[4]/SCK0/ CAP0[1]	27	I/O	<b>SCK0</b> — Serial clock for SPI0. SPI clock output from master or input to slave.
		I	<b>CAP0[1]</b> — Capture input for Timer 0, channel 1.
P0[5]/MISO0/ MAT0[1]	29	I/O	<b>MISO0</b> — Master In Slave OUT for SPI0. Data input to SPI master or data output from SPI slave.
		O	<b>MAT0[1]</b> — Match output for Timer 0, channel 1.
P0[6]/MOSI0/ CAP0[2]	30	I/O	<b>MOSI0</b> — Master Out Slave In for SPI0. Data output from SPI master or data input to SPI slave.
		I	<b>CAP0[2]</b> — Capture input for Timer 0, channel 2.
P0[7]/SSEL0/ PWM2/EINT2	31	I	<b>SSEL0</b> — Slave Select for SPI0. Selects the SPI interface as a slave.
		O	<b>PWM2</b> — Pulse Width Modulator output 2.
		I	<b>EINT2</b> — External interrupt 2 input.
P0[8]/TXD1/ PWM4	33	O	<b>TXD1</b> — Transmitter output for UART1.
		O	<b>PWM4</b> — Pulse Width Modulator output 4.
P0[9]/RXD1/ PWM6/EINT3	34	I	<b>RXD1</b> — Receiver input for UART1.
		O	<b>PWM6</b> — Pulse Width Modulator output 6.
		I	<b>EINT3</b> — External interrupt 3 input.
P0[10]/RTS1/ CAP1[0]	35	O	<b>RTS1</b> — Request to Send output for UART1.
		I	<b>CAP1[0]</b> — Capture input for Timer 1, channel 0.
P0[11]/CTS1/ CAP1[1]	37	I	<b>CTS1</b> — Clear to Send input for UART1.
		I	<b>CAP1[1]</b> — Capture input for Timer 1, channel 1.
P0[12]/DSR1/ MAT1[0]	38	I	<b>DSR1</b> — Data Set Ready input for UART1.
		O	<b>MAT1[0]</b> — Match output for Timer 1, channel 0.
P0[13]/DTR1/ MAT1[1]	39	O	<b>DTR1</b> — Data Terminal Ready output for UART1.
		O	<b>MAT1[1]</b> — Match output for Timer 1, channel 1.
P0[14]/DCD1/ EINT1	41	I	<b>DCD1</b> — Data Carrier Detect input for UART1.
		I	<b>EINT1</b> — External interrupt 1 input. <b>Note:</b> LOW on this pin while $\overline{\text{RESET}}$ is LOW forces on-chip bootloader to take control of the part after reset.

Table 3. Pin description ...continued

Symbol	Pin	Type	Description
P0[15]/RI1/EINT2	45	I	<b>RI1</b> — Ring Indicator input for UART1.
		I	<b>EINT2</b> — External interrupt 2 input.
P0[16]/EINT0/ MAT0[2]/CAP0[2]	46	I	<b>EINT0</b> — External interrupt 0 input.
		O	<b>MAT0[2]</b> — Match output for Timer 0, channel 2.
		I	<b>CAP0[2]</b> — Capture input for Timer 0, channel 2.
P0[17]/CAP1[2]/ SCK1/MAT1[2]	47	I	<b>CAP1[2]</b> — Capture input for Timer 1, channel 2.
		I/O	<b>SCK1</b> — Serial Clock for SPI1/SSP[1]. SPI clock output from master or input to slave.
		O	<b>MAT1[2]</b> — Match output for Timer 1, channel 2.
P0[18]/CAP1[3]/ MISO1/MAT1[3]	53	I	<b>CAP1[3]</b> — Capture input for Timer 1, channel 3.
		I/O	<b>MISO1</b> — Master In Slave Out for SPI1/SSP[1]. Data input to SPI master or data output from SPI slave.
		O	<b>MAT1[3]</b> — Match output for Timer 1, channel 3.
P0[19]/MAT1[2]/ MOSI1/CAP1[2]	54	O	<b>MAT1[2]</b> — Match output for Timer 1, channel 2.
		I/O	<b>MOSI1</b> — Master Out Slave In for SPI1/SSP[1]. Data output from SPI master or data input to SPI slave.
		I	<b>CAP1[2]</b> — Capture input for Timer 1, channel 2.
P0[20]/MAT1[3]/ SSEL1/EINT3	55	O	<b>MAT1[3]</b> — Match output for Timer 1, channel 3.
		I	<b>SSEL1</b> — Slave Select for SPI1/SSP[1]. Selects the SPI interface as a slave.
		I	<b>EINT3</b> — External interrupt 3 input.
P0[21]/PWM5/ CAP1[3]	1	O	<b>PWM5</b> — Pulse Width Modulator output 5.
		I	<b>CAP1[3]</b> — Capture input for Timer 1, channel 3.
P0[22]/CAP0[0]/ MAT0[0]	2	I	<b>CAP0[0]</b> — Capture input for Timer 0, channel 0.
		O	<b>MAT0[0]</b> — Match output for Timer 0, channel 0.
P0[23]/RD2	3	I	CAN2 receiver input (not available on LPC2109).
P0[24]/TD2	5	O	CAN2 transmitter output (not available on LPC2109).
P0[25]/RD1	9	I	CAN1 receiver input.
P0[27]/AIN0/ CAP0[1]/MAT0[1]	11	I	<b>AIN0</b> — A/D converter, input 0. This analog input is always connected to its pin.
		I	<b>CAP0[1]</b> — Capture input for Timer 0, channel 1.
		O	<b>MAT0[1]</b> — Match output for Timer 0, channel 1.
P0[28]/AIN1/ CAP0[2]/MAT0[2]	13	I	<b>AIN1</b> — A/D converter, input 1. This analog input is always connected to its pin.
		I	<b>CAP0[2]</b> — Capture input for Timer 0, channel 2.
		O	<b>MAT0[2]</b> — Match output for Timer 0, channel 2.
P0[29]/AIN2/ CAP0[3]/MAT0[3]	14	I	<b>AIN2</b> — A/D converter, input 2. This analog input is always connected to its pin.
		I	<b>CAP0[3]</b> — Capture input for Timer 0, Channel 3.
		O	<b>MAT0[3]</b> — Match output for Timer 0, channel 3.
P0[30]/AIN3/ EINT3/CAP0[0]	15	I	<b>AIN3</b> — A/D converter, input 3. This analog input is always connected to its pin.
		I	<b>EINT3</b> — External interrupt 3 input.
		I	<b>CAP0[0]</b> — Capture input for Timer 0, channel 0.
P1[0] to P1[31]		I/O	Port 1 is a 32-bit bidirectional I/O port with individual direction controls for each bit. The operation of port 1 pins depends upon the pin function selected via the Pin Connect Block. Pins 0 through 15 of port 1 are not available.

Table 3. Pin description ...continued

Symbol	Pin	Type	Description
P1[16]/TRACEPKT0	16	O	Trace Packet, bit 0. Standard I/O port with internal pull-up.
P1[17]/TRACEPKT1	12	O	Trace Packet, bit 1. Standard I/O port with internal pull-up.
P1[18]/TRACEPKT2	8	O	Trace Packet, bit 2. Standard I/O port with internal pull-up.
P1[19]/TRACEPKT3	4	O	Trace Packet, bit 3. Standard I/O port with internal pull-up.
P1[20]/TRACESYNC	48	O	Trace Synchronization. Standard I/O port with internal pull-up. <b>Note:</b> LOW on this pin while $\overline{\text{RESET}}$ is LOW, enables pins P1[25:16] to operate as Trace port after reset.
P1[21]/PIPESTAT0	44	O	Pipeline Status, bit 0. Standard I/O port with internal pull-up.
P1[22]/PIPESTAT1	40	O	Pipeline Status, bit 1. Standard I/O port with internal pull-up.
P1[23]/PIPESTAT2	36	O	Pipeline Status, bit 2. Standard I/O port with internal pull-up.
P1[24]/TRACECLK	32	O	Trace Clock. Standard I/O port with internal pull-up.
P1[25]/EXTIN0	28	I	External Trigger Input. Standard I/O with internal pull-up.
P1[26]/RTCK	24	I/O	Returned Test Clock output. Extra signal added to the JTAG port. Assists debugger synchronization when processor frequency varies. Bidirectional pin with internal pull-up. <b>Note:</b> LOW on this pin while $\overline{\text{RESET}}$ is LOW, enables pins P1[31:26] to operate as Debug port after reset.
P1[27]/TDO	64	O	Test Data out for JTAG interface.
P1[28]/TDI	60	I	Test Data in for JTAG interface.
P1[29]/TCK	56	I	Test Clock for JTAG interface. This clock must be slower than $\frac{1}{6}$ of the CPU clock (CCLK) for the JTAG interface to operate.
P1[30]/TMS	52	I	Test Mode Select for JTAG interface.
P1[31]/ $\overline{\text{TRST}}$	20	I	Test Reset for JTAG interface.
TD1	10	O	CAN1 transmitter output.
$\overline{\text{RESET}}$	57	I	External reset input; a LOW on this pin resets the device, causing I/O ports and peripherals to take on their default states, and processor execution to begin at address 0. TTL with hysteresis, 5 V tolerant.
XTAL1	62	I	Input to the oscillator circuit and internal clock generator circuits.
XTAL2	61	O	Output from the oscillator amplifier.
$V_{\text{SS}}$	6, 18, 25, 42, 50	I	Ground: 0 V reference.
$V_{\text{SSA}}$	59	I	Analog ground; 0 V reference. This should nominally be the same voltage as $V_{\text{SS}}$ , but should be isolated to minimize noise and error.
$V_{\text{SSA(PLL)}}$	58	I	PLL analog ground; 0 V reference. This should nominally be the same voltage as $V_{\text{SS}}$ , but should be isolated to minimize noise and error.
$V_{\text{DD(1V8)}}$	17, 49	I	1.8 V core power supply; this is the power supply voltage for internal circuitry.



**Table 3.** Pin description ...continued

Symbol	Pin	Type	Description
$V_{DDA(1V8)}$	63	I	Analog 1.8 V core power supply; this is the power supply voltage for internal circuitry. This should be nominally the same voltage as $V_{DD(1V8)}$ but should be isolated to minimize noise and error.
$V_{DD(3V3)}$	23, 43, 51	I	3.3 V pad power supply; this is the power supply voltage for the I/O ports.
$V_{DDA(3V3)}$	7	I	Analog 3.3 V pad power supply; this should be nominally the same voltage as $V_{DD(3V3)}$ but should be isolated to minimize noise and error.

[1] SSP interface available on LPC2109/01, LPC2119/01, and LPC2129/01 only.

## 6. Functional description

Details of the LPC2109/2119/2129 systems and peripheral functions are described in the following sections.

### 6.1 Architectural overview

The ARM7TDMI-S is a general purpose 32-bit microprocessor, which offers high performance and very low power consumption. The ARM architecture is based on Reduced Instruction Set Computer (RISC) principles, and the instruction set and related decode mechanism are much simpler than those of microprogrammed Complex Instruction Set Computers. This simplicity results in a high instruction throughput and impressive real-time interrupt response from a small and cost-effective processor core.

Pipeline techniques are employed so that all parts of the processing and memory systems can operate continuously. Typically, while one instruction is being executed, its successor is being decoded, and a third instruction is being fetched from memory.

The ARM7TDMI-S processor also employs a unique architectural strategy known as Thumb, which makes it ideally suited to high-volume applications with memory restrictions, or applications where code density is an issue.

The key idea behind Thumb is that of a super-reduced instruction set. Essentially, the ARM7TDMI-S processor has two instruction sets:

- The standard 32-bit ARM set.
- A 16-bit Thumb set.

The Thumb set's 16-bit instruction length allows it to approach twice the density of standard ARM code while retaining most of the ARM's performance advantage over a traditional 16-bit processor using 16-bit registers. This is possible because Thumb code operates on the same 32-bit register set as ARM code.

Thumb code is able to provide up to 65 % of the code size of ARM, and 160 % of the performance of an equivalent ARM processor connected to a 16-bit memory system.

### 6.2 On-chip flash program memory

The LPC2109/2119/2129 incorporate a 64/128/256 kB flash memory system, respectively. This memory may be used for both code and data storage. Programming of the flash memory may be accomplished in several ways. It may be programmed In System via the serial port. The application program may also erase and/or program the flash while the application is running, allowing a great degree of flexibility for data storage field firmware upgrades, etc. When on-chip bootloader is used, 60/120/248 kB of flash memory is available for user code.

The LPC2109/2119/2129 flash memory provides a minimum of 100000 erase/write cycles and 20 years of data retention.

On-chip bootloader (as of revision 1.60) provides Code Read Protection (CRP) for the LPC2109/2119/2129 on-chip flash memory. When the CRP is enabled, the JTAG debug port and ISP commands accessing either the on-chip RAM or flash memory are disabled.

However, the ISP flash erase command can be executed at any time (no matter whether the CRP is on or off). Removal of CRP is achieved by erasure of full on-chip user flash. With the CRP off, full access to the chip via the JTAG and/or ISP is restored.

### 6.3 On-chip static RAM

On-chip static RAM may be used for code and/or data storage. The SRAM may be accessed as 8 bit, 16 bit, and 32 bit. The LPC2109/2119/2129 provide 8 kB of static RAM for the LPC2109 and 16 kB for the LPC2119 and LPC2129.

### 6.4 Memory map

The LPC2109/2119/2129 memory maps incorporate several distinct regions, as shown in [Figure 3](#).

In addition, the CPU interrupt vectors may be re-mapped to allow them to reside in either flash memory (the default) or on-chip static RAM. This is described in [Section 6.18](#) “[System control](#)”.

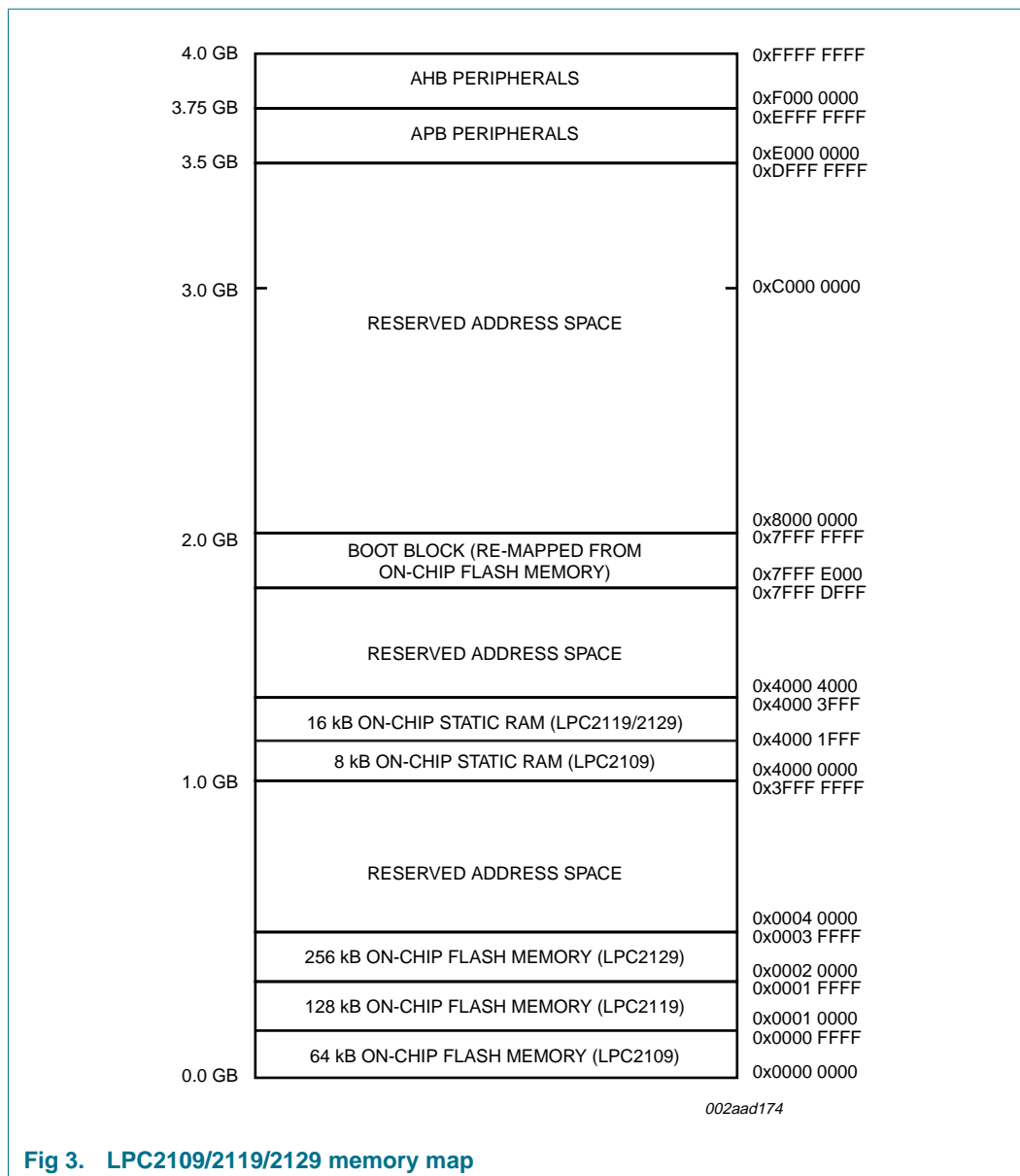

Fig 3. LPC2109/2119/2129 memory map

## 6.5 Interrupt controller

The Vectored Interrupt Controller (VIC) accepts all of the interrupt request inputs and categorizes them as Fast Interrupt reQuest (FIQ), vectored Interrupt Request (IRQ), and non-vectored IRQ as defined by programmable settings. The programmable assignment scheme means that priorities of interrupts from the various peripherals can be dynamically assigned and adjusted.

FIQ has the highest priority. If more than one request is assigned to FIQ, the VIC combines the requests to produce the FIQ signal to the ARM processor. The fastest possible FIQ latency is achieved when only one request is classified as FIQ because then the FIQ service routine can simply start dealing with that device. But if more than one request is assigned to the FIQ class, the FIQ service routine can read a word from the VIC that identifies which FIQ source(s) is (are) requesting an interrupt.

Vectored IRQs have the middle priority. Sixteen of the interrupt requests can be assigned to this category. Any of the interrupt requests can be assigned to any of the 16 vectored IRQ slots, among which slot 0 has the highest priority and slot 15 has the lowest.

Non-vectored IRQs have the lowest priority.

The VIC combines the requests from all the vectored and non-vectored IRQs to produce the IRQ signal to the ARM processor. The IRQ service routine can start by reading a register from the VIC and jumping there. If any of the vectored IRQs are requesting, the VIC provides the address of the highest-priority requesting IRQs service routine, otherwise it provides the address of a default routine that is shared by all the non-vectored IRQs. The default routine can read another VIC register to see what IRQs are active.

### 6.5.1 Interrupt sources

Table 4 lists the interrupt sources for each peripheral function. Each peripheral device has one interrupt line connected to the Vectored Interrupt Controller, but may have several internal interrupt flags. Individual interrupt flags may also represent more than one interrupt source.

**Table 4. Interrupt sources**

Block	Flag(s)	VIC channel #
WDT	Watchdog Interrupt (WDINT)	0
-	Reserved for software interrupts only	1
ARM Core	EmbeddedICE, DbgCommRx	2
ARM Core	EmbeddedICE, DbgCommTx	3
Timer 0	Match 0 to 3 (MR0, MR1, MR2, MR3) Capture 0 to 3 (CR0, CR1, CR2, CR3)	4
Timer 1	Match 0 to 3 (MR0, MR1, MR2, MR3) Capture 0 to 3 (CR0, CR1, CR2, CR3)	5
UART0	Rx Line Status (RLS) Transmit Holding Register empty (THRE) Rx Data Available (RDA) Character Time-out Indicator (CTI)	6
UART1	Rx Line Status (RLS) Transmit Holding Register empty (THRE) Rx Data Available (RDA) Character Time-out Indicator (CTI) Modem Status Interrupt (MSI)	7
PWM0	Match 0 to 6 (MR0, MR1, MR2, MR3, MR4, MR5, MR6)	8
I <sup>2</sup> C-bus	SI (state change)	9
SPI0	SPIF, MODF	10
SPI1 and SSP <sup>[1]</sup>	SPIF, MODF and TXRIS, RXRIS, RTRIS, RORRIS	11
PLL	PLL Lock (PLOCK)	12
RTC	RTCCIF (Counter Increment), RTCALF (Alarm)	13

Table 4. Interrupt sources ...continued

Block	Flag(s)	VIC channel #
System Control	External Interrupt 0 (EINT0)	14
	External Interrupt 1 (EINT1)	15
	External Interrupt 2 (EINT2)	16
	External Interrupt 3 (EINT3)	17
ADC	A/D Converter	18
CAN	CAN1, CAN2 and Acceptance Filter	19 to 23

[1] SSP interface available on LPC2109/01, LPC2119/01, and LPC2129/01 only.

## 6.6 Pin connect block

The pin connect block allows selected pins of the microcontroller to have more than one function. Configuration registers control the multiplexers to allow connection between the pin and the on-chip peripherals. Peripherals should be connected to the appropriate pins prior to being activated, and prior to any related interrupt(s) being enabled. Activity of any enabled peripheral function that is not mapped to a related pin should be considered undefined.

## 6.7 General purpose parallel I/O (GPIO) and Fast I/O

Device pins that are not connected to a specific peripheral function are controlled by the parallel I/O registers. Pins may be dynamically configured as inputs or outputs. Separate registers allow setting or clearing any number of outputs simultaneously. The value of the output register may be read back, as well as the current state of the port pins.

### 6.7.1 Features

- Bit-level set and clear registers allow a single instruction set or clear of any number of bits in one port.
- Direction control of individual bits.
- Separate control of output set and clear.
- All I/O default to inputs after reset.

### 6.7.2 Features added with the Fast GPIO set of registers available on LPC2109/2119/2129/01 only

- Fast GPIO registers are relocated to the ARM local bus for the fastest possible I/O timing, enabling port pin toggling up to 3.5 times faster than earlier LPC2000 devices.
- Mask registers allow treating sets of port bits as a group, leaving other bits unchanged.
- All Fast GPIO registers are byte addressable.
- Entire port value can be written in one instruction.
- Ports are accessible via either the legacy group of registers (GPIOs) or the group of registers providing accelerated port access (Fast GPIOs).

## 6.8 10-bit ADC

The LPC2109/2119/2129 each contain a single 10-bit successive approximation ADC with four multiplexed channels.

### 6.8.1 Features

- Measurement range of 0 V to 3 V.
- Capable of performing more than 400000 10-bit samples per second.
- Burst conversion mode for single or multiple inputs.
- Optional conversion on transition on input pin or Timer Match signal.

### 6.8.2 ADC features available in LPC2109/2119/2129/01 only

- Every analog input has a dedicated result register to reduce interrupt overhead.
- Every analog input can generate an interrupt once the conversion is completed.
- The ADC pads are 5 V tolerant when configured for digital I/O function(s).

## 6.9 CAN controllers and acceptance filter

The LPC2119 and LPC2129 each contain two CAN controllers, while the LPC2109 has one CAN controller. The CAN is a serial communications protocol which efficiently supports distributed real-time control with a very high level of security. Its domain of application ranges from high-speed networks to low-cost multiplex wiring.

### 6.9.1 Features

- Data rates up to 1 Mbit/s on each bus.
- 32-bit register and RAM access.
- Compatible with CAN specification 2.0B, ISO 11898-1.
- Global Acceptance Filter recognizes 11-bit and 29-bit Rx identifiers for all CAN buses.
- Acceptance Filter can provide FullCAN-style automatic reception for selected Standard identifiers.

## 6.10 UARTs

The LPC2109/2119/2129 each contain two UARTs. In addition to standard transmit and receive data lines, the UART1 also provides a full modem control handshake interface.

### 6.10.1 Features

- 16 B Receive and Transmit FIFOs.
- Register locations conform to 16C550 industry standard.
- Receiver FIFO trigger points at 1 B, 4 B, 8 B, and 14 B.
- Built-in fractional baud rate generator covering wide range of baud rates without a need for external crystals of particular values.
- Transmission FIFO control enables implementation of software (XON/XOFF) flow control on both UARTs.

- UART1 is equipped with standard modem interface signals. This module also provides full support for hardware flow control (auto-CTS/RTS).

### 6.10.2 UART features available in LPC2109/2119/2129/01 only

Compared to previous LPC2000 microcontrollers, UARTs in LPC2109/2119/2129/01 introduce a fractional baud rate generator for both UARTs, enabling these microcontrollers to achieve standard baud rates such as 115200 Bd with any crystal frequency above 2 MHz. In addition, auto-CTS/RTS flow-control functions are fully implemented in hardware.

- Fractional baud rate generator enables standard baud rates such as 115200 Bd to be achieved with any crystal frequency above 2 MHz.
- Auto-bauding.
- Auto-CTS/RTS flow-control fully implemented in hardware.

## 6.11 I<sup>2</sup>C-bus serial I/O controller

The I<sup>2</sup>C-bus is a bidirectional bus for inter-IC control using only two wires: a serial clock line (SCL), and a serial data line (SDA). Each device is recognized by a unique address and can operate as either a receiver-only device (e.g. an LCD driver or a transmitter with the capability to both receive and send information (such as memory). Transmitters and/or receivers can operate in either master or slave mode, depending on whether the chip has to initiate a data transfer or is only addressed. The I<sup>2</sup>C-bus is a multi-master bus; it can be controlled by more than one bus master connected to it.

The I<sup>2</sup>C-bus implemented in LPC2109/2119/2129 supports a bit rate up to 400 kbit/s (Fast I<sup>2</sup>C-bus).

### 6.11.1 Features

- Standard I<sup>2</sup>C-bus compliant interface.
- Easy to configure as Master, Slave, or Master/Slave.
- Programmable clocks allow versatile rate control.
- Bidirectional data transfer between masters and slaves.
- Multi-master bus (no central master).
- Arbitration between simultaneously transmitting masters without corruption of serial data on the bus.
- Serial clock synchronization allows devices with different bit rates to communicate via one serial bus.
- Serial clock synchronization can be used as a handshake mechanism to suspend and resume serial transfer.
- The I<sup>2</sup>C-bus may be used for test and diagnostic purposes.



## 6.12 SPI serial I/O controller

The LPC2109/2119/2129 each contain two SPIs. The SPI is a full duplex serial interface, designed to be able to handle multiple masters and slaves connected to a given bus. Only a single master and a single slave can communicate on the interface during a given data transfer. During a data transfer the master always sends a byte of data to the slave, and the slave always sends a byte of data to the master.

### 6.12.1 Features

- Compliant with Serial Peripheral Interface (SPI) specification.
- Synchronous, Serial, Full Duplex communication.
- Combined SPI master and slave.
- Maximum data bit rate of  $\frac{1}{8}$  of the input clock rate.

### 6.12.2 Features available in LPC2109/2119/2129/01 only

- Eight to 16 bits per frame.
- When the SPI interface is used in Master mode, the SSELn pin is not needed (can be used for a different function).

## 6.13 SSP controller (LPC2109/2119/2129/01 only)

**Remark:** This peripheral is available in LPC2109/2119/2129/01 only.

The SSP is a controller capable of operation on a SPI, 4-wire SSI, or Microwire bus. It can interact with multiple masters and slaves on the bus. Only a single master and a single slave can communicate on the bus during a given data transfer. Data transfers are in principle full duplex, with frames of four to 16 bits of data flowing from the master to the slave and from the slave to the master.

While the SSP and SPI1 peripherals share the same physical pins, it is not possible to have both of these two peripherals active at the same time. Application can switch on the fly from SPI1 to SSP and back.

### 6.13.1 Features

- Compatible with Motorola's SPI, Texas Instrument's 4-wire SSI, and National Semiconductor's Microwire buses.
- Synchronous serial communication.
- Master or slave operation.
- 8-frame FIFOs for both transmit and receive.
- Four to 16 bits per frame.

## 6.14 General purpose timers

The Timer/Counter is designed to count cycles of the peripheral clock (PCLK) or an externally supplied clock and optionally generate interrupts or perform other actions at specified timer values, based on four match registers. It also includes four capture inputs

to trap the timer value when an input signal transitions, optionally generating an interrupt. Multiple pins can be selected to perform a single capture or match function, providing an application with 'or' and 'and', as well as 'broadcast' functions among them.

### 6.14.1 Features

- A 32-bit Timer/Counter with a programmable 32-bit Prescaler.
- Timer or external event counter operation
- Four 32-bit capture channels per timer that can take a snapshot of the timer value when an input signal transitions. A capture event may also optionally generate an interrupt.
- Four 32-bit match registers that allow:
  - Continuous operation with optional interrupt generation on match.
  - Stop timer on match with optional interrupt generation.
  - Reset timer on match with optional interrupt generation.
- Four external outputs per timer corresponding to match registers, with the following capabilities:
  - Set LOW on match.
  - Set HIGH on match.
  - Toggle on match.
  - Do nothing on match.

### 6.14.2 Features available in LPC2109/2119/2129/01 only

The LPC2109/2119/2129/01 can count external events on one of the capture inputs if the external pulse lasts at least one half of the period of the PCLK. In this configuration, unused capture lines can be selected as regular timer capture inputs, or used as external interrupts.

- Timer can count cycles of either the peripheral clock (PCLK) or an externally supplied clock.
- When counting cycles of an externally supplied clock, only one of the timer's capture inputs can be selected as the timer's clock. The rate of such a clock is limited to  $PCLK / 4$ . Duration of HIGH/LOW levels on the selected CAP input cannot be shorter than  $1 / (2PCLK)$ .

## 6.15 Watchdog timer

The purpose of the watchdog is to reset the microcontroller within a reasonable amount of time if it enters an erroneous state. When enabled, the watchdog will generate a system reset if the user program fails to 'feed' (or reload) the watchdog within a predetermined amount of time.

### 6.15.1 Features

- Internally resets chip if not periodically reloaded.
- Debug mode.

- Enabled by software but requires a hardware reset or a watchdog reset/interrupt to be disabled.
- Incorrect/incomplete feed sequence causes reset/interrupt if enabled.
- Flag to indicate watchdog reset.
- Programmable 32-bit timer with internal pre-scaler.
- Selectable time period from  $(T_{cy(PCLK)} \times 256 \times 4)$  to  $(T_{cy(PCLK)} \times 2^{32} \times 4)$  in multiples of  $T_{cy(PCLK)} \times 4$ .

## 6.16 Real-time clock

The RTC is designed to provide a set of counters to measure time when normal or idle operating mode is selected. The RTC has been designed to use little power, making it suitable for battery powered systems where the CPU is not running continuously (Idle mode).

### 6.16.1 Features

- Measures the passage of time to maintain a calendar and clock.
- Ultra low power design to support battery powered systems.
- Provides Seconds, Minutes, Hours, Day of Month, Month, Year, Day of Week, and Day of Year.
- Programmable reference clock divider allows adjustment of the RTC to match various crystal frequencies.

## 6.17 Pulse width modulator

The PWM is based on the standard Timer block and inherits all of its features, although only the PWM function is pinned out on the LPC2109/2119/2129. The Timer is designed to count cycles of the peripheral clock (PCLK) and optionally generate interrupts or perform other actions when specified timer values occur, based on seven match registers. The PWM function is also based on match register events.

The ability to separately control rising and falling edge locations allows the PWM to be used for more applications. For instance, multi-phase motor control typically requires three non-overlapping PWM outputs with individual control of all three pulse widths and positions.

Two match registers can be used to provide a single edge controlled PWM output. One match register (MR0) controls the PWM cycle rate, by resetting the count upon match. The other match register controls the PWM edge position. Additional single edge controlled PWM outputs require only one match register each, since the repetition rate is the same for all PWM outputs. Multiple single edge controlled PWM outputs will all have a rising edge at the beginning of each PWM cycle, when an MR0 match occurs.

Three match registers can be used to provide a PWM output with both edges controlled. Again, the MR0 match register controls the PWM cycle rate. The other match registers control the two PWM edge positions. Additional double edge controlled PWM outputs require only two match registers each, since the repetition rate is the same for all PWM outputs.

With double edge controlled PWM outputs, specific match registers control the rising and falling edge of the output. This allows both positive going PWM pulses (when the rising edge occurs prior to the falling edge), and negative going PWM pulses (when the falling edge occurs prior to the rising edge).

### 6.17.1 Features

- Seven match registers allow up to six single edge controlled or three double edge controlled PWM outputs, or a mix of both types.
- The match registers also allow:
  - Continuous operation with optional interrupt generation on match.
  - Stop timer on match with optional interrupt generation.
  - Reset timer on match with optional interrupt generation.
- Supports single edge controlled and/or double edge controlled PWM outputs. Single edge controlled PWM outputs all go HIGH at the beginning of each cycle unless the output is a constant LOW. Double edge controlled PWM outputs can have either edge occur at any position within a cycle. This allows for both positive going and negative going pulses.
- Pulse period and width can be any number of timer counts. This allows complete flexibility in the trade-off between resolution and repetition rate. All PWM outputs will occur at the same repetition rate.
- Double edge controlled PWM outputs can be programmed to be either positive going or negative going pulses.
- Match register updates are synchronized with pulse outputs to prevent generation of erroneous pulses. Software must 'release' new match values before they can become effective.
- May be used as a standard timer if the PWM mode is not enabled.
- A 32-bit Timer/Counter with a programmable 32-bit Prescaler.

## 6.18 System control

### 6.18.1 Crystal oscillator

The oscillator supports crystals in the range of 1 MHz to 30 MHz. The oscillator output frequency is called  $f_{osc}$  and the ARM processor clock frequency is referred to as CCLK for purposes of rate equations, etc..  $f_{osc}$  and CCLK are the same value unless the PLL is running and connected. Refer to [Section 6.18.2 "PLL"](#) for additional information.

### 6.18.2 PLL

The PLL accepts an input clock frequency in the range of 10 MHz to 25 MHz. The input frequency is multiplied up into the range of 10 MHz to 60 MHz with a Current Controlled Oscillator (CCO). The multiplier can be an integer value from 1 to 32 (in practice, the multiplier value cannot be higher than 6 on this family of microcontrollers due to the upper frequency limit of the CPU). The CCO operates in the range of 156 MHz to 320 MHz, so there is an additional divider in the loop to keep the CCO within its frequency range while the PLL is providing the desired output frequency. The output divider may be set to divide by 2, 4, 8, or 16 to produce the output clock. Since the minimum output divider value is 2, it is insured that the PLL output has a 50 % duty cycle. The PLL is turned off and bypassed following a chip Reset and may be enabled by software. The program must configure and activate the PLL, wait for the PLL to Lock, then connect to the PLL as a clock source. The PLL settling time is 100  $\mu$ s.

### 6.18.3 Reset and wake-up timer

Reset has two sources on the LPC2109/2119/2129: the  $\overline{\text{RESET}}$  pin and Watchdog Reset. The  $\overline{\text{RESET}}$  pin is a Schmitt trigger input pin with an additional glitch filter. Assertion of chip Reset by any source starts the Wake-up Timer (see Wake-up Timer description below), causing the internal chip reset to remain asserted until the external Reset is de-asserted, the oscillator is running, a fixed number of clocks have passed, and the on-chip flash controller has completed its initialization.

When the internal Reset is removed, the processor begins executing at address 0, which is the Reset vector. At that point, all of the processor and peripheral registers have been initialized to predetermined values.

The wake-up timer ensures that the oscillator and other analog functions required for chip operation are fully functional before the processor is allowed to execute instructions. This is important at power on, all types of Reset, and whenever any of the aforementioned functions are turned off for any reason. Since the oscillator and other functions are turned off during Power-down mode, any wake-up of the processor from Power-down mode makes use of the Wake-up Timer.

The Wake-up Timer monitors the crystal oscillator as the means of checking whether it is safe to begin code execution. When power is applied to the chip, or some event caused the chip to exit Power-down mode, some time is required for the oscillator to produce a signal of sufficient amplitude to drive the clock logic. The amount of time depends on many factors, including the rate of  $V_{DD}$  ramp (in the case of power on), the type of crystal and its electrical characteristics (if a quartz crystal is used), as well as any other external circuitry (e.g. capacitors), and the characteristics of the oscillator itself under the existing ambient conditions.

### 6.18.4 Code security (Code Read Protection - CRP)

This feature of the LPC2109/2119/2129 allows the user to enable different levels of security in the system so that access to the on-chip flash and use of the JTAG and ISP can be restricted. When needed, CRP is invoked by programming a specific pattern into a dedicated flash location. IAP commands are not affected by the CRP.

There are three levels of the Code Read Protection.

CRP1 disables access to chip via the JTAG and allows partial flash update (excluding flash sector 0) using a limited set of the ISP commands. This mode is useful when CRP is required and flash field updates are needed but all sectors can not be erased.

CRP2 disables access to chip via the JTAG and only allows full flash erase and update using a reduced set of the ISP commands.

Running an application with level CRP3 selected fully disables any access to chip via the JTAG pins and the ISP. This mode effectively disables ISP override using P0[14] pin, too. It is up to the user's application to provide (if needed) flash update mechanism using IAP calls or call reinvoke ISP command to enable flash update via UART0.

**CAUTION**

If level three Code Read Protection (CRP3) is selected, no future factory testing can be performed on the device.

**Remark:** Devices without the suffix /00 or /01 have only a security level equivalent to CRP2 available.

### 6.18.5 External interrupt inputs

The LPC2109/2119/2129 include up to nine edge or level sensitive External Interrupt Inputs as selectable pin functions. When the pins are combined, external events can be processed as four independent interrupt signals. The External Interrupt Inputs can optionally be used to wake up the processor from Power-down mode.

### 6.18.6 Memory mapping control

The Memory Mapping Control alters the mapping of the interrupt vectors that appear beginning at address 0x0000 0000. Vectors may be mapped to the bottom of the on-chip flash memory, or to the on-chip static RAM. This allows code running in different memory spaces to have control of the interrupts.

### 6.18.7 Power control

The LPC2109/2119/2129 support two reduced power modes: Idle mode and Power-down mode. In Idle mode, execution of instructions is suspended until either a Reset or interrupt occurs. Peripheral functions continue operation during Idle mode and may generate interrupts to cause the processor to resume execution. Idle mode eliminates power used by the processor itself, memory systems and related controllers, and internal buses.

In Power-down mode, the oscillator is shut down and the chip receives no internal clocks. The processor state and registers, peripheral registers, and internal SRAM values are preserved throughout Power-down mode and the logic levels of chip output pins remain static. The Power-down mode can be terminated and normal operation resumed by either a Reset or certain specific interrupts that are able to function without clocks. Since all dynamic operation of the chip is suspended, Power-down mode reduces chip power consumption to nearly zero.

A Power Control for Peripherals feature allows individual peripherals to be turned off if they are not needed in the application, resulting in additional power savings.

### 6.18.8 APB

The APB divider determines the relationship between the processor clock (CCLK) and the clock used by peripheral devices (PCLK). The APB divider serves two purposes. The first is to provide peripherals with the desired PCLK via APB so that they can operate at the speed chosen for the ARM processor. In order to achieve this, the APB may be slowed down to  $\frac{1}{2}$  to  $\frac{1}{4}$  of the processor clock rate. Because the APB must work properly at power-up (and its timing cannot be altered if it does not work since the APB divider control registers reside on the APB), the default condition at reset is for the APB to run at  $\frac{1}{4}$  of the processor clock rate. The second purpose of the APB divider is to allow power savings when an application does not require any peripherals to run at the full processor rate. Because the APB divider is connected to the PLL output, the PLL remains active (if it was running) during Idle mode.

## 6.19 Emulation and debugging

The LPC2109/2119/2129 support emulation and debugging via a JTAG serial port. A trace port allows tracing program execution. Debugging and trace functions are multiplexed only with GPIOs on Port 1. This means that all communication, timer and interface peripherals residing on Port 0 are available during the development and debugging phase as they are when the application is run in the embedded system itself.

### 6.19.1 EmbeddedICE

Standard ARM EmbeddedICE logic provides on-chip debug support. The debugging of the target system requires a host computer running the debugger software and an EmbeddedICE protocol convertor. EmbeddedICE protocol convertor converts the Remote Debug Protocol commands to the JTAG data needed to access the ARM core.

The ARM core has a Debug Communication Channel function built-in. The debug communication channel allows a program running on the target to communicate with the host debugger or another separate host without stopping the program flow or even entering the debug state. The debug communication channel is accessed as a co-processor 14 by the program running on the ARM7TDMI-S core. The debug communication channel allows the JTAG port to be used for sending and receiving data without affecting the normal program flow. The debug communication channel data and control registers are mapped in to addresses in the EmbeddedICE logic.

The JTAG clock (TCK) must be slower than  $\frac{1}{6}$  of the CPU clock (CCLK) for the JTAG interface to operate.

### 6.19.2 Embedded trace macrocell

Since the LPC2109/2119/2129 have significant amounts of on-chip memory, it is not possible to determine how the processor core is operating simply by observing the external pins. The ETM provides real-time trace capability for deeply embedded processor cores. It outputs information about processor execution to the trace port.

The ETM is connected directly to the ARM core and not to the main AMBA system bus. It compresses the trace information and exports it through a narrow trace port. An external trace port analyzer must capture the trace information under software debugger control. Instruction trace (or PC trace) shows the flow of execution of the processor and provides a list of all the instructions that were executed. Instruction trace is significantly compressed by only broadcasting branch addresses as well as a set of status signals that indicate the

pipeline status on a cycle by cycle basis. Trace information generation can be controlled by selecting the trigger resource. Trigger resources include address comparators, counters and sequencers. Since trace information is compressed the software debugger requires a static image of the code being executed. Self-modifying code can not be traced because of this restriction.

### 6.19.3 RealMonitor

RealMonitor is a configurable software module, developed by ARM Inc., which enables real time debug. It is a lightweight debug monitor that runs in the background while users debug their foreground application. It communicates with the host using the DCC (Debug Communications Channel), which is present in the EmbeddedICE logic. The LPC2109/2119/2129 contain a specific configuration of RealMonitor software programmed into the on-chip flash memory.



## 7. Limiting values

**Table 5. Limiting values**

In accordance with the Absolute Maximum Rating System (IEC 60134).<sup>[1]</sup>

Symbol	Parameter	Conditions	Min	Max	Unit
$V_{DD(1V8)}$	supply voltage (1.8 V)		[2] -0.5	+2.5	V
$V_{DD(3V3)}$	supply voltage (3.3 V)		[3] -0.5	+3.6	V
$V_{DDA(3V3)}$	analog supply voltage (3.3 V)		-0.5	+4.6	V
$V_{IA}$	analog input voltage		-0.5	+5.1	V
$V_I$	input voltage	5 V tolerant I/O pins	[4][5] -0.5	+6.0	V
		other I/O pins	[4][6] -0.5	$V_{DD(3V3)} + 0.5$	V
$I_{DD}$	supply current		[7][8] -	100	mA
$I_{SS}$	ground current		[8][9] -	100	mA
$T_j$	junction temperature		-	150	°C
$T_{stg}$	storage temperature		[10] -65	+150	°C
$P_{tot(pack)}$	total power dissipation (per package)	based on package heat transfer, not device power consumption	-	1.5	W
$V_{esd}$	electrostatic discharge voltage	human body model; all pins	[11] -2000	+2000	V

[1] The following applies to [Table 5](#):

- a) This product includes circuitry specifically designed for the protection of its internal devices from the damaging effects of excessive static charge. Nonetheless, it is suggested that conventional precautions be taken to avoid applying greater than the rated maximum.
- b) Parameters are valid over operating temperature range unless otherwise specified. All voltages are with respect to  $V_{SS}$  unless otherwise noted.

[2] Internal rail.

[3] External rail.

[4] Including voltage on outputs in 3-state mode.

[5] Only valid when the  $V_{DD(3V3)}$  supply voltage is present.

[6] Not to exceed 4.6 V.

[7] Per supply pin.

[8] The peak current is limited to 25 times the corresponding maximum current.

[9] Per ground pin.

[10] Dependent on package type.

[11] Human body model: equivalent to discharging a 100 pF capacitor through a 1.5 kΩ series resistor.

## 8. Static characteristics

**Table 6. Static characteristics**

$T_{amb} = -40\text{ }^{\circ}\text{C}$  to  $+85\text{ }^{\circ}\text{C}$  for industrial applications, unless otherwise specified.

Symbol	Parameter	Conditions	Min	Typ <sup>[1]</sup>	Max	Unit
$V_{DD(1V8)}$	supply voltage (1.8 V)		[2] 1.65	1.8	1.95	V
$V_{DD(3V3)}$	supply voltage (3.3 V)		[3] 3.0	3.3	3.6	V
$V_{DDA(3V3)}$	analog supply voltage (3.3 V)		2.5	3.3	3.6	V

### Standard port pins, $\overline{\text{RESET}}$ , $\overline{\text{RTCK}}$

$I_{IL}$	LOW-level input current	$V_I = 0\text{ V}$ ; no pull-up	-	-	3	$\mu\text{A}$
$I_{IH}$	HIGH-level input current	$V_I = V_{DD(3V3)}$ ; no pull-down	-	-	3	$\mu\text{A}$
$I_{OZ}$	OFF-state output current	$V_O = 0\text{ V}$ ; $V_O = V_{DD(3V3)}$ ; no pull-up/down	-	-	3	$\mu\text{A}$
$I_{latch}$	I/O latch-up current	$-(0.5V_{DD(3V3)}) < V_I < (1.5V_{DD(3V3)})$ ; $T_j < 125\text{ }^{\circ}\text{C}$	100	-	-	mA
$V_I$	input voltage		[4][5][6] 0	-	5.5	V
$V_O$	output voltage	output active	0	-	$V_{DD(3V3)}$	V
$V_{IH}$	HIGH-level input voltage		2.0	-	-	V
$V_{IL}$	LOW-level input voltage		-	-	0.8	V
$V_{hys}$	hysteresis voltage		-	0.4	-	V
$V_{OH}$	HIGH-level output voltage	$I_{OH} = -4\text{ mA}$	[7] $V_{DD(3V3)} - 0.4$	-	-	V
$V_{OL}$	LOW-level output voltage	$I_{OL} = 4\text{ mA}$	[7] -	-	0.4	V
$I_{OH}$	HIGH-level output current	$V_{OH} = V_{DD(3V3)} - 0.4\text{ V}$	[7] -4	-	-	mA
$I_{OL}$	LOW-level output current	$V_{OL} = 0.4\text{ V}$	[7] 4	-	-	mA
$I_{OHS}$	HIGH-level short-circuit output current	$V_{OH} = 0\text{ V}$	[8] -	-	-45	mA
$I_{OLS}$	LOW-level short-circuit output current	$V_{OL} = V_{DD(3V3)}$	[8] -	-	50	mA
$I_{pd}$	pull-down current	$V_I = 5\text{ V}$	[9] 10	50	150	$\mu\text{A}$
$I_{pu}$	pull-up current	$V_I = 0\text{ V}$	[10] -15	-50	-85	$\mu\text{A}$
		$V_{DD(3V3)} < V_I < 5\text{ V}$	[9] 0	0	0	$\mu\text{A}$

### Power consumption LPC2109/00, LPC2119, LPC2119/00, LPC2129, LPC2129/00

$I_{DD(act)}$	active mode supply current	$V_{DD(1V8)} = 1.8\text{ V}$ ; CCLK = 60 MHz; $T_{amb} = 25\text{ }^{\circ}\text{C}$ ; code while(1){} executed from flash; all peripherals enabled via PCONP <sup>[11]</sup> register but not configured to run	-	60	-	mA
$I_{DD(pd)}$	Power-down mode supply current	$V_{DD(1V8)} = 1.8\text{ V}$ ; $T_{amb} = 25\text{ }^{\circ}\text{C}$	-	10	-	$\mu\text{A}$
		$V_{DD(1V8)} = 1.8\text{ V}$ ; $T_{amb} = 85\text{ }^{\circ}\text{C}$	-	110	500	$\mu\text{A}$

**Table 6. Static characteristics ...continued** $T_{amb} = -40\text{ }^{\circ}\text{C}$  to  $+85\text{ }^{\circ}\text{C}$  for industrial applications, unless otherwise specified.

Symbol	Parameter	Conditions	Min	Typ <sup>[1]</sup>	Max	Unit
<b>Power consumption LPC2109/01, LPC2119/01, LPC2129/01</b>						
$I_{DD(act)}$	active mode supply current	$V_{DD(1V8)} = 1.8\text{ V}$ ; CCLK = 60 MHz; $T_{amb} = 25\text{ }^{\circ}\text{C}$ ; code while(1){} executed from flash; all peripherals enabled via PCONP <sup>[11]</sup> register but not configured to run	-	41.5	-	mA
$I_{DD(idle)}$	Idle mode supply current	$V_{DD(1V8)} = 1.8\text{ V}$ ; CCLK = 60 MHz; $T_{amb} = 25\text{ }^{\circ}\text{C}$ ; executed from flash; all peripherals enabled via PCONP <sup>[11]</sup> register but not configured to run	-	9	-	mA
$I_{DD(pd)}$	Power-down mode supply current	$V_{DD(1V8)} = 1.8\text{ V}$ ; $T_{amb} = 25\text{ }^{\circ}\text{C}$	-	10	-	$\mu\text{A}$
		$V_{DD(1V8)} = 1.8\text{ V}$ ; $T_{amb} = 85\text{ }^{\circ}\text{C}$	-	-	180	$\mu\text{A}$
<b>I<sup>2</sup>C-bus pins</b>						
$V_{IH}$	HIGH-level input voltage		$0.7V_{DD(3V3)}$	-	-	V
$V_{IL}$	LOW-level input voltage		-	-	$0.3V_{DD(3V3)}$	V
$V_{hys}$	hysteresis voltage		-	$0.5V_{DD(3V3)}$	-	V
$V_{OL}$	LOW-level output voltage	$I_{OLS} = 3\text{ mA}$	<sup>[7]</sup> -	-	0.4	V
$I_{LI}$	input leakage current	$V_I = V_{DD(3V3)}$	<sup>[12]</sup> -	2	4	$\mu\text{A}$
		$V_I = 5\text{ V}$	-	10	22	$\mu\text{A}$
<b>Oscillator pins</b>						
$V_{i(XTAL1)}$	input voltage on pin XTAL1		0	-	1.8	V
$V_{o(XTAL2)}$	output voltage on pin XTAL2		0	-	1.8	V

[1] Typical ratings are not guaranteed. The values listed are at room temperature (25 °C), nominal supply voltages.

[2] Internal rail.

[3] External rail.

[4] Including voltage on outputs in 3-state mode.

[5]  $V_{DD(3V3)}$  supply voltages must be present.[6] 3-state outputs go into 3-state mode when  $V_{DD(3V3)}$  is grounded.

[7] Accounts for 100 mV voltage drop in all supply lines.

[8] Only allowed for a short time period.

[9] Minimum condition for  $V_I = 4.5\text{ V}$ , maximum condition for  $V_I = 5.5\text{ V}$ .[10] Applies to P1<sup>[25:16]</sup>.

[11] See LPC2119/2129/2194/2292/2294 User Manual.

[12] To  $V_{SS}$ .

**Table 7. ADC static characteristics**

$V_{DDA} = 2.5\text{ V}$  to  $3.6\text{ V}$  unless otherwise specified;  $T_{amb} = -40\text{ }^{\circ}\text{C}$  to  $+85\text{ }^{\circ}\text{C}$  unless otherwise specified. ADC frequency  $4.5\text{ MHz}$ .

Symbol	Parameter	Conditions	Min	Typ	Max	Unit
$V_{IA}$	analog input voltage		0	-	$V_{DDA}$	V
$C_{ia}$	analog input capacitance		-	-	1	pF
$E_D$	differential linearity error	[1][2][3]	-	-	$\pm 1$	LSB
$E_{L(adj)}$	integral non-linearity	[1][4]	-	-	$\pm 2$	LSB
$E_O$	offset error	[1][5]	-	-	$\pm 3$	LSB
$E_G$	gain error	[1][6]	-	-	$\pm 0.5$	%
$E_T$	absolute error	[1][7]	-	-	$\pm 4$	LSB

[1] Conditions:  $V_{SSA} = 0\text{ V}$ ,  $V_{DDA} = 3.3\text{ V}$ .

[2] The ADC is monotonic, there are no missing codes.

[3] The differential linearity error ( $E_D$ ) is the difference between the actual step width and the ideal step width. See [Figure 4](#).

[4] The integral non-linearity ( $E_{L(adj)}$ ) is the peak difference between the center of the steps of the actual and the ideal transfer curve after appropriate adjustment of gain and offset errors. See [Figure 4](#).

[5] The offset error ( $E_O$ ) is the absolute difference between the straight line which fits the actual curve and the straight line which fits the ideal curve. See [Figure 4](#).

[6] The gain error ( $E_G$ ) is the relative difference in percent between the straight line fitting the actual transfer curve after removing offset error, and the straight line which fits the ideal transfer curve. See [Figure 4](#).

[7] The absolute voltage error ( $E_T$ ) is the maximum difference between the center of the steps of the actual transfer curve of the non-calibrated ADC and the ideal transfer curve. See [Figure 4](#).

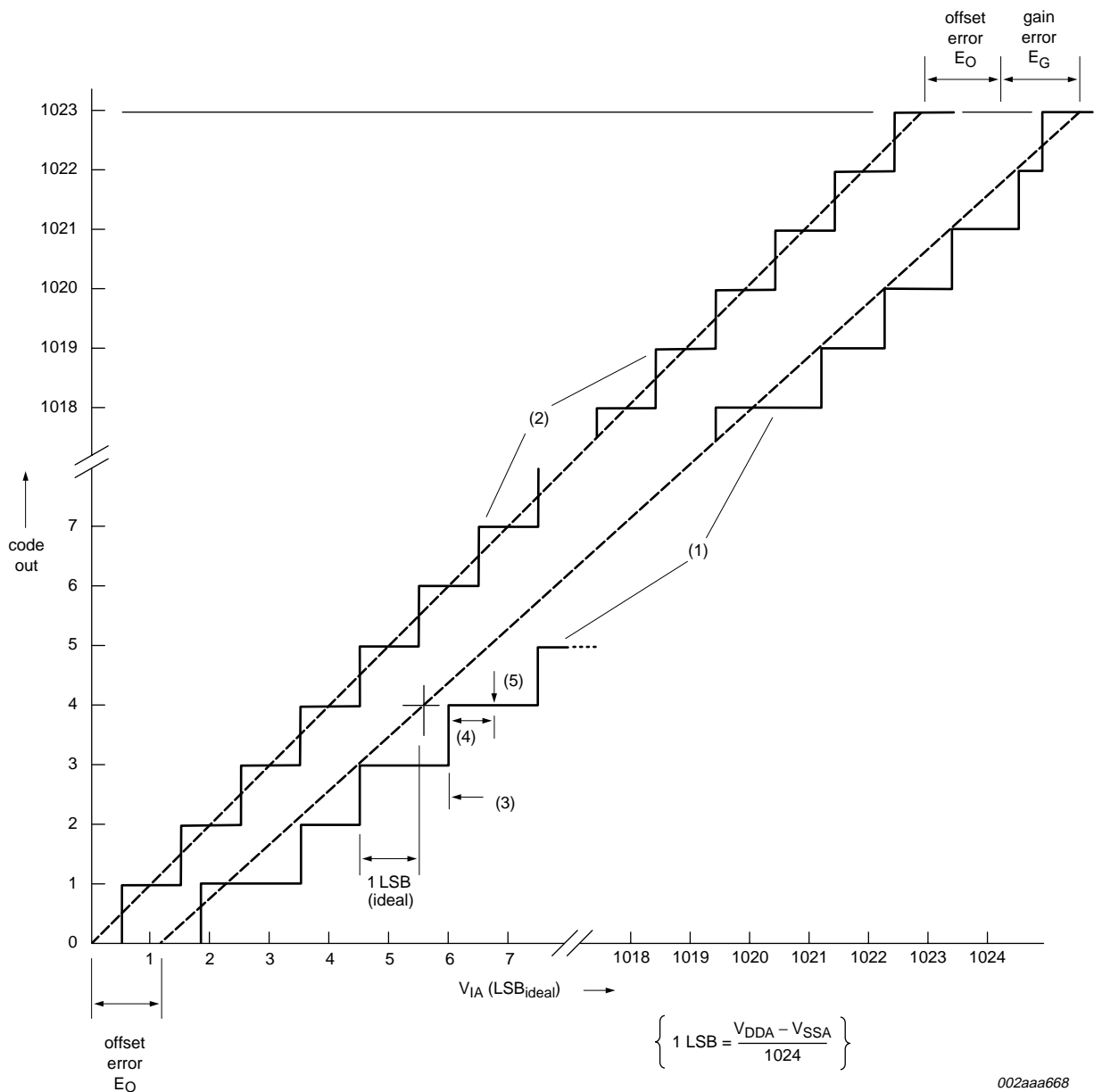

- (1) Example of an actual transfer curve.
- (2) The ideal transfer curve.
- (3) Differential linearity error ( $E_D$ ).
- (4) Integral non-linearity ( $E_{L(\text{adj})}$ ).
- (5) Center of a step of the actual transfer curve.

**Fig 4. ADC characteristics**

### 8.1 Power consumption measurements for LPC2109/01, LPC2119/01, LPC2129/01 devices

The power consumption measurements represent typical values for the given conditions. The peripherals were enabled through the PCONP register, but for these measurements, the peripherals were not configured to run. Peripherals were disabled through the PCONP register. Refer to the *LPC2119/2129/2194/2292/2294 User Manual* for a description of the PCONP register.

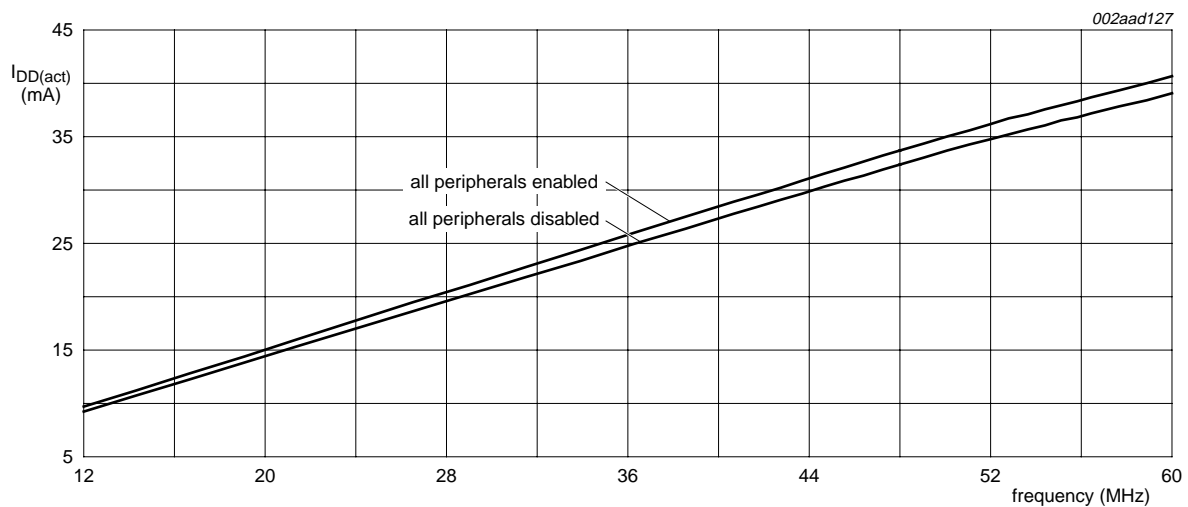

Test conditions: Active mode entered executing code from on-chip flash; PCLK =  $CCLK/4$ ;  
 $T_{amb} = 25\text{ }^{\circ}\text{C}$ ; core voltage 1.8 V.

**Fig 5. Typical LPC2109/01  $I_{DD(act)}$  measured at different frequencies**

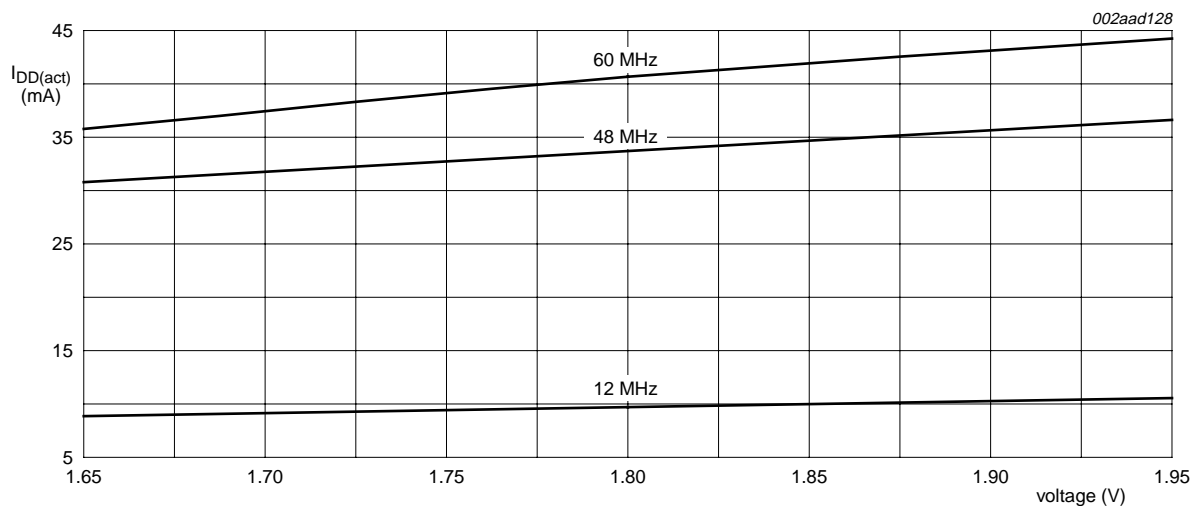

Test conditions: Active mode entered executing code from on-chip flash; PCLK =  $CCLK/4$ ;  
 $T_{amb} = 25\text{ }^{\circ}\text{C}$ ; core voltage 1.8 V; all peripherals enabled.

**Fig 6. Typical LPC2109/01  $I_{DD(act)}$  measured at different voltages**

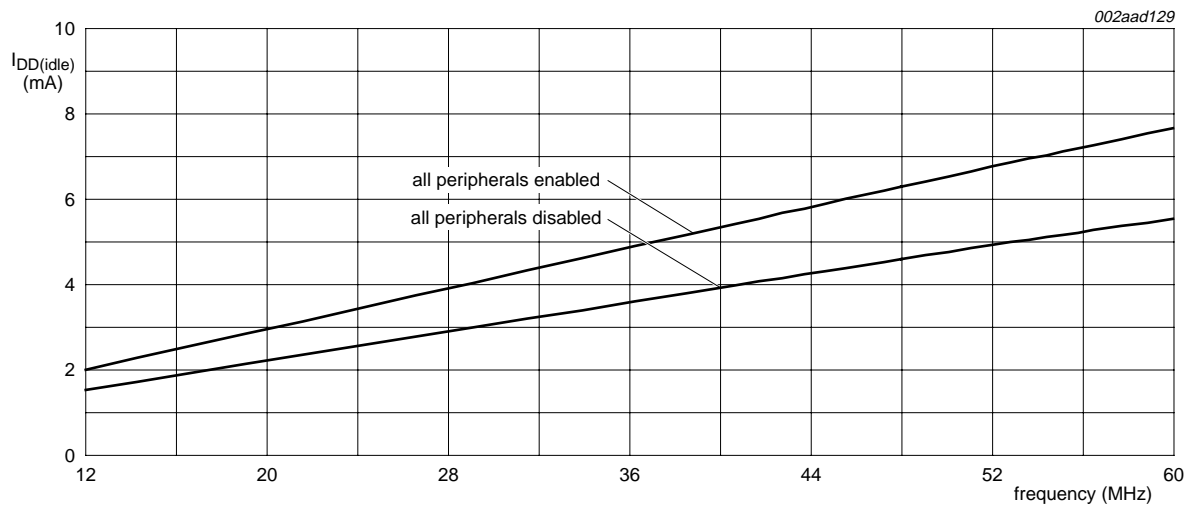

Test conditions: Idle mode entered executing code from on-chip flash; PCLK =  $CCLK/4$ ;  
 $T_{amb} = 25\text{ }^{\circ}\text{C}$ ; core voltage 1.8 V.

Fig 7. Typical LPC2109/01  $I_{DD(idle)}$  measured at different frequencies

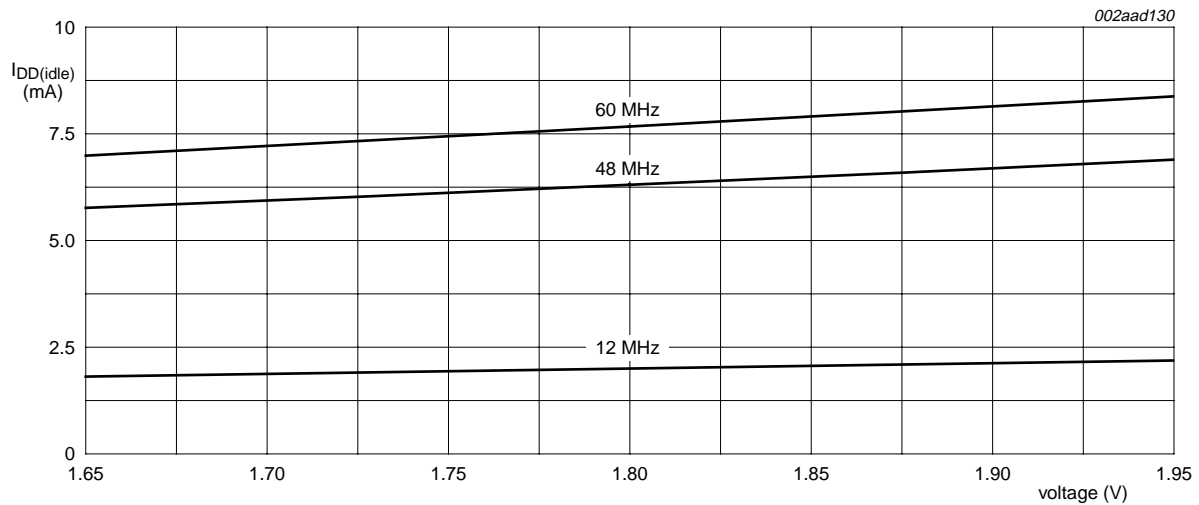

Test conditions: Idle mode entered executing code from on-chip flash; PCLK =  $CCLK/4$ ;  
 $T_{amb} = 25\text{ }^{\circ}\text{C}$ ; core voltage 1.8 V; all peripherals enabled.

Fig 8. Typical LPC2109/01  $I_{DD(idle)}$  measured at different voltages

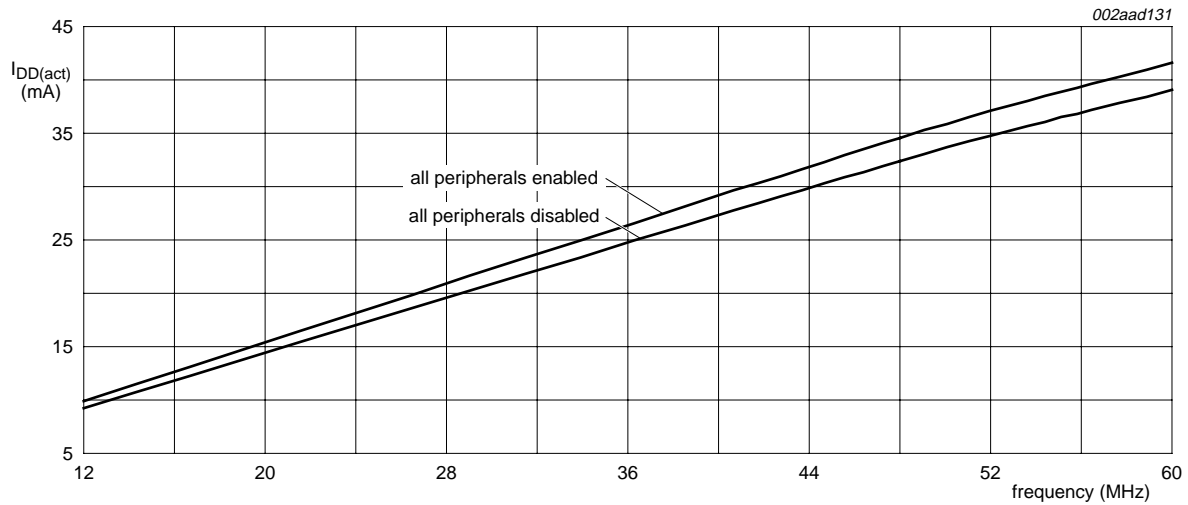

Test conditions: Active mode entered executing code from on-chip flash; PCLK =  $CCLK/4$ ;  
 $T_{amb} = 25\text{ }^{\circ}\text{C}$ ; core voltage 1.8 V.

Fig 9. Typical LPC2119/01 and LPC2129/01  $I_{DD(act)}$  measured at different frequencies

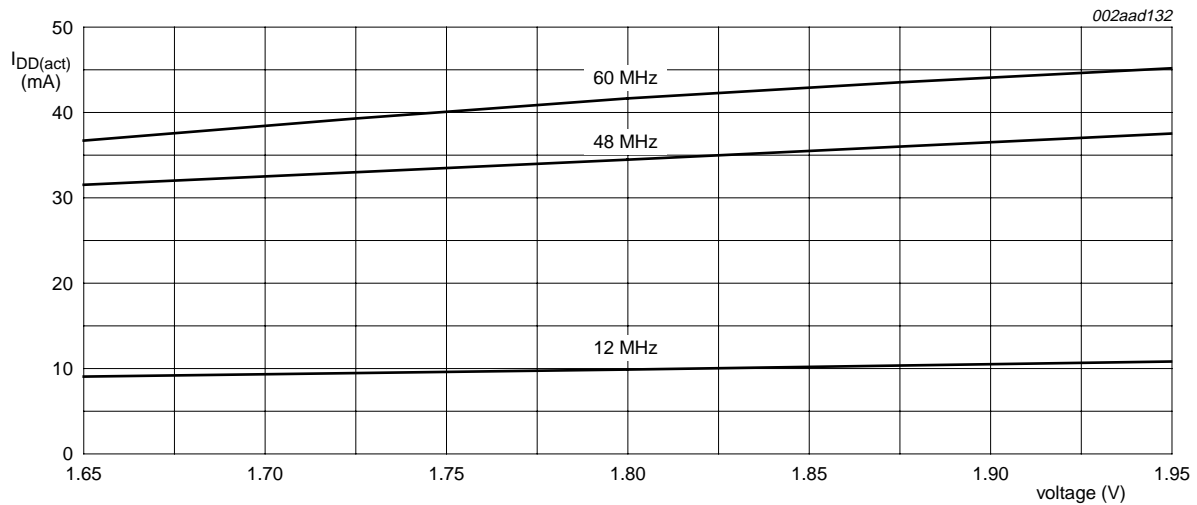

Test conditions: Active mode entered executing code from on-chip flash; PCLK =  $CCLK/4$ ;  
 $T_{amb} = 25\text{ }^{\circ}\text{C}$ ; core voltage 1.8 V; all peripherals enabled.

Fig 10. Typical LPC2119/01 and LPC2129/01  $I_{DD(act)}$  measured at different voltages



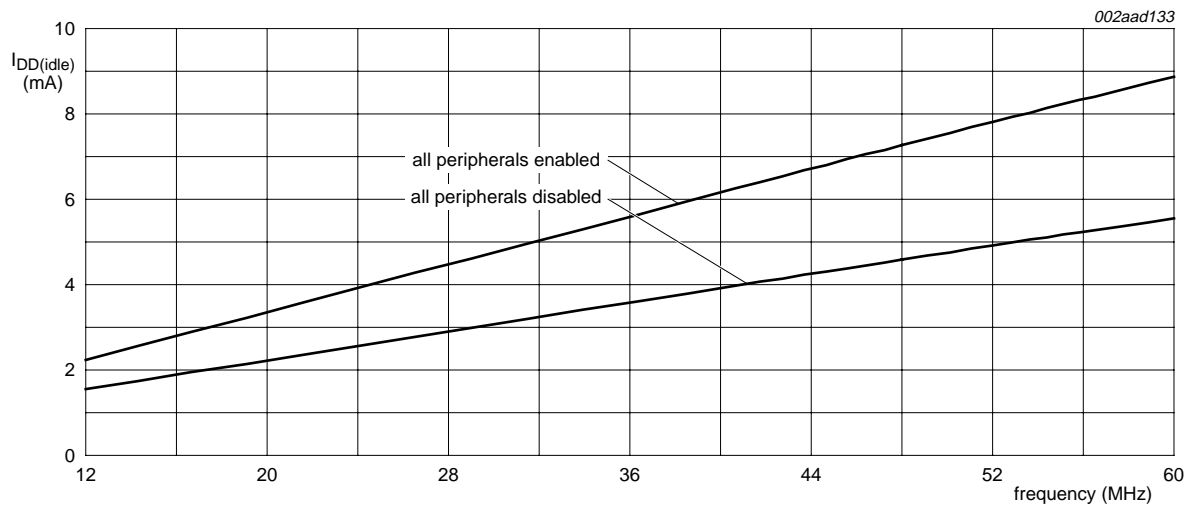

Test conditions: Idle mode entered executing code from on-chip flash;  $PCLK = CCLK/4$ ;  
 $T_{amb} = 25\text{ }^{\circ}\text{C}$ ; core voltage 1.8 V.

Fig 11. Typical LPC2119/01 and LPC2129/01  $I_{DD(idle)}$  measured at different frequencies

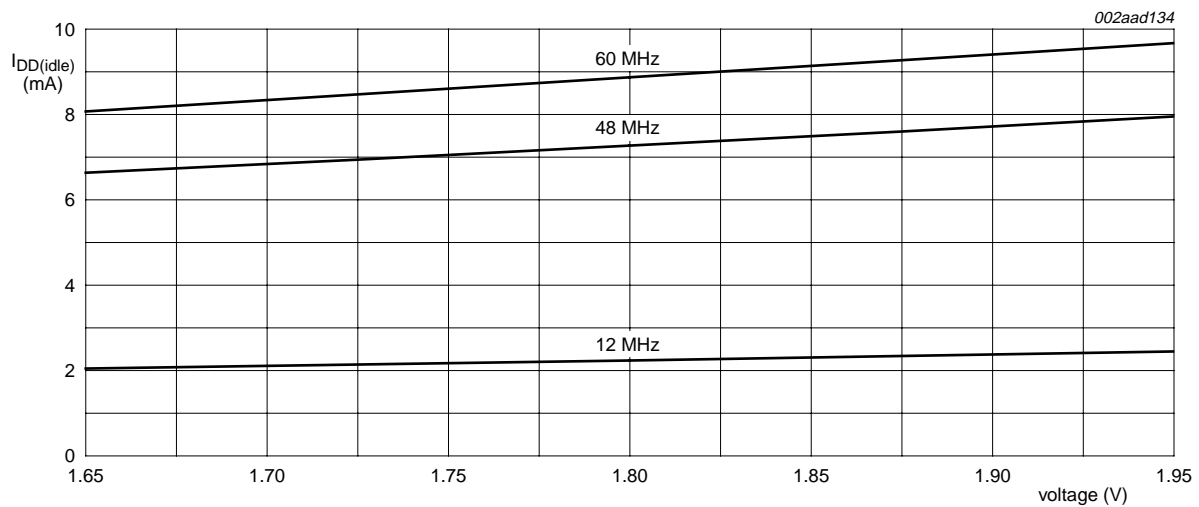

Test conditions: Idle mode entered executing code from on-chip flash;  $PCLK = CCLK/4$ ;  
 $T_{amb} = 25\text{ }^{\circ}\text{C}$ ; core voltage 1.8 V; all peripherals enabled.

Fig 12. Typical LPC2119/01 and LPC2129/01  $I_{DD(idle)}$  measured at different voltages

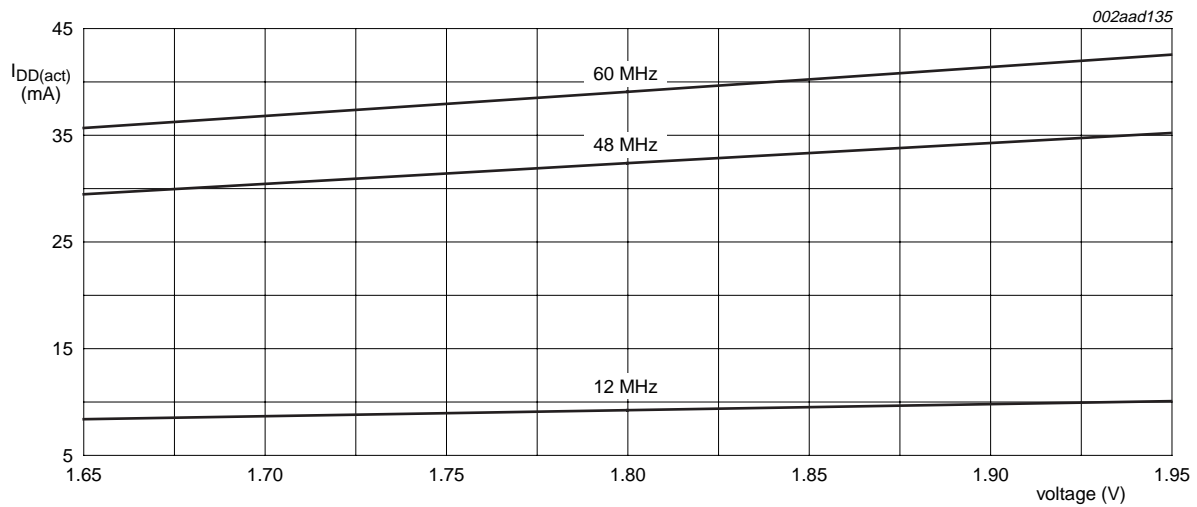

Test conditions: Active mode entered executing code from on-chip flash; PCLK =  $CCLK/4$ ;  
Temp = 25 °C; core voltage 1.8 V; all peripherals disabled.

Fig 13. Typical LPC2109/01, LPC2119/01, and LPC2129/01  $I_{DD(act)}$  measured at different voltages

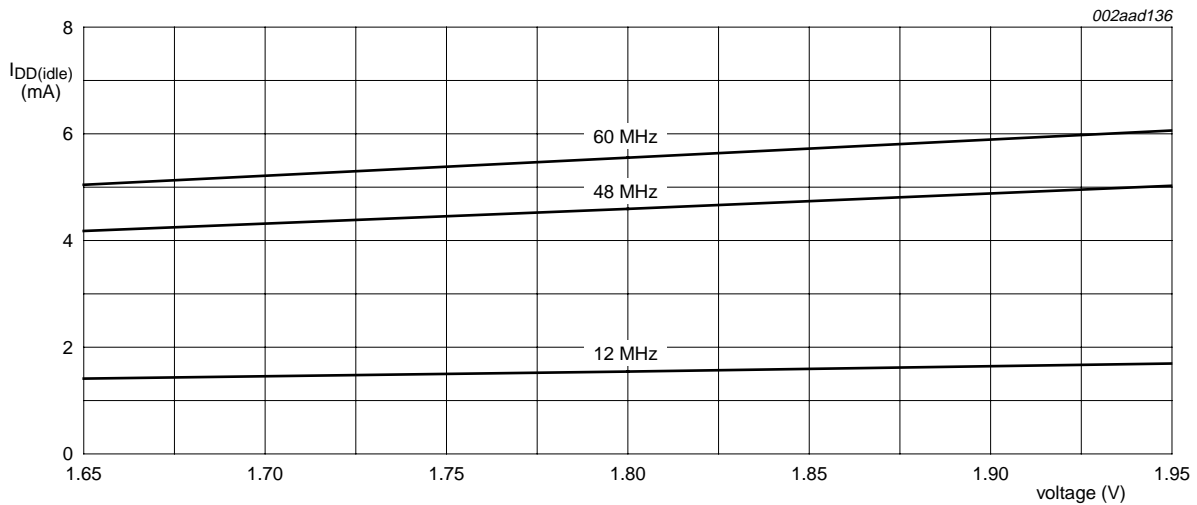

Test conditions: Idle mode entered executing code from on-chip flash; PCLK =  $CCLK/4$ ;  
Temp = 25 °C; core voltage 1.8 V; all peripherals disabled.

Fig 14. Typical LPC2109/01, LPC2119/01, and LPC2129/01  $I_{DD(idle)}$  measured at different voltages

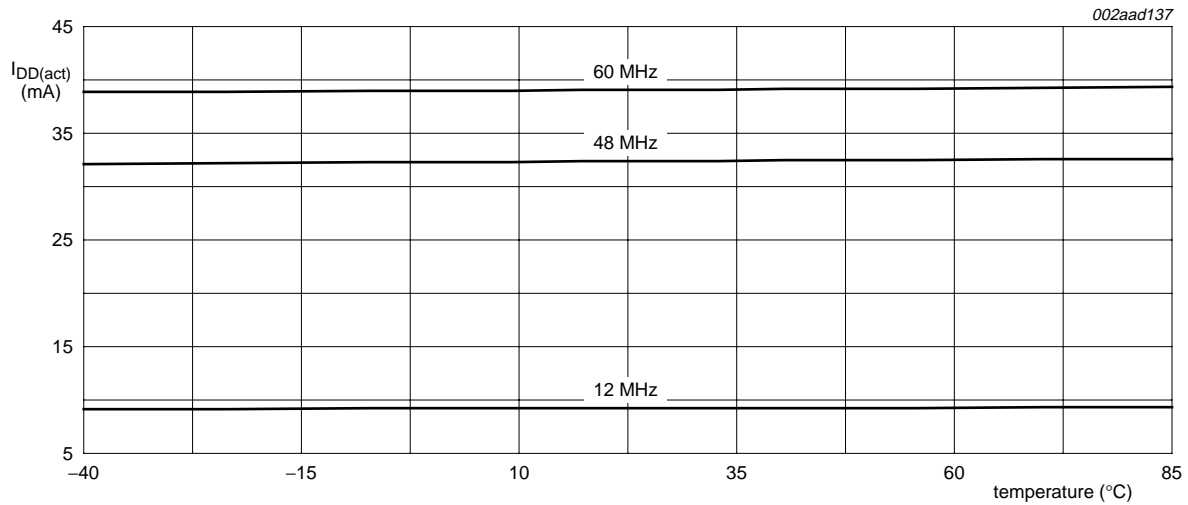

Test conditions: Active mode entered executing code from on-chip flash; PCLK =  $CCLK/4$ ;  
core voltage 1.8 V; all peripherals disabled.

**Fig 15. Typical LPC2109/01, LPC2119/01, and LPC2129/01  $I_{DD(Act)}$  measured at different temperatures**

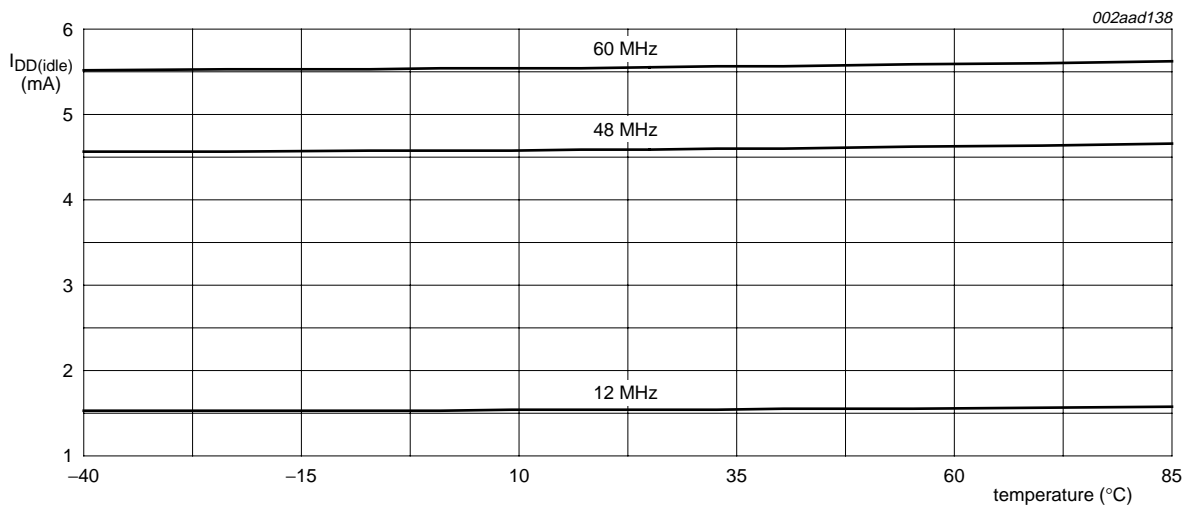

Test conditions: Idle mode entered executing code from on-chip flash; PCLK =  $CCLK/4$ ;  
core voltage 1.8 V; all peripherals disabled.

**Fig 16. Typical LPC2109/01, LPC2119/01, and LPC2129/01  $I_{DD(Idle)}$  measured at different temperatures**

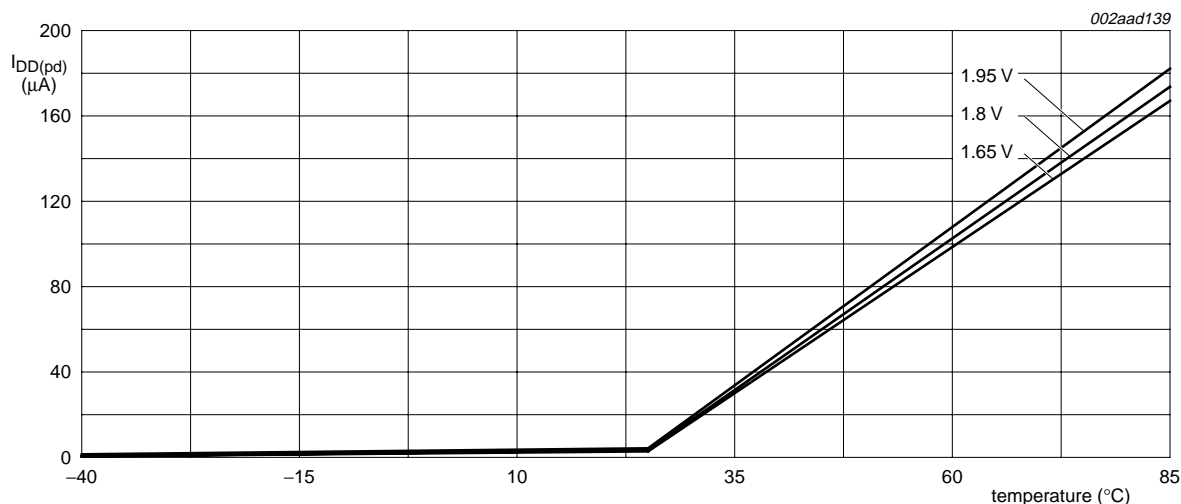

Test conditions: Power-down mode entered executing code from on-chip flash.

**Fig 17. Typical LPC2109/01, LPC2119/01, and LPC2129/01 core power-down current  $I_{DD(pd)}$  measured at different temperatures**

**Table 8. Typical LPC2109/01 peripheral power consumption in active mode**

Core voltage 1.8 V;  $T_{amb} = 25\text{ }^{\circ}\text{C}$ ; all measurements in  $\mu\text{A}$ ;  $PCLK = CCLK/4$ .

Peripheral	CCLK = 12 MHz	CCLK = 48 MHz	CCLK = 60 MHz
Timer0	43	141	184
Timer1	46	150	180
UART0	98	320	398
UART1	103	351	421
PWM0	103	341	407
I <sup>2</sup> C-bus	9	37	53
SPI0/1	6	27	29
RTC	16	55	78
ADC	33	128	167
CAN1	230	764	914

**Table 9. Typical LPC2119/01 and LPC2129/01 peripheral power consumption in active mode**

Core voltage 1.8 V;  $T_{amb} = 25\text{ }^{\circ}\text{C}$ ; all measurements in  $\mu\text{A}$ ;  $PCLK = CCLK/4$ .

Peripheral	CCLK = 12 MHz	CCLK = 48 MHz	CCLK = 60 MHz
Timer0	43	141	184
Timer1	46	150	180
UART0	98	320	398
UART1	103	351	421
PWM0	103	341	407
I <sup>2</sup> C-bus	9	37	53
SPI0/1	6	27	29

**Table 9. Typical LPC2119/01 and LPC2129/01 peripheral power consumption in active mode ...continued**

Core voltage 1.8 V;  $T_{amb} = 25\text{ }^{\circ}\text{C}$ ; all measurements in  $\mu\text{A}$ ;  $PCLK = CCLK/4$ .

Peripheral	CCLK = 12 MHz	CCLK = 48 MHz	CCLK = 60 MHz
RTC	16	55	78
ADC	33	128	167
CAN1/2	229	771	914

## 9. Dynamic characteristics

**Table 10. Dynamic characteristics**

$T_{amb} = -40\text{ }^{\circ}\text{C}$  to  $+85\text{ }^{\circ}\text{C}$  for industrial applications;  $V_{DD(1V8)}$ ,  $V_{DD(3V3)}$  over specified ranges.<sup>[1]</sup>

Symbol	Parameter	Conditions	Min	Typ	Max	Unit
<b>External clock</b>						
$f_{osc}$	oscillator frequency	supplied by an external oscillator (signal generator)	1	-	50	MHz
		external clock frequency supplied by an external crystal oscillator	1	-	30	MHz
		external clock frequency if on-chip PLL is used	10	-	25	MHz
		external clock frequency if on-chip bootloader is used for initial code download	10	-	25	MHz
$T_{cy(clk)}$	clock cycle time		20	-	1000	ns
$t_{CHCX}$	clock HIGH time		$T_{cy(clk)} \times 0.4$	-	-	ns
$t_{CLCX}$	clock LOW time		$T_{cy(clk)} \times 0.4$	-	-	ns
$t_{CLCH}$	clock rise time		-	-	5	ns
$t_{CHCL}$	clock fall time		-	-	5	ns
<b>Port pins (except P0[2] and P0[3])</b>						
$t_r$	rise time		-	10	-	ns
$t_f$	fall time		-	10	-	ns
<b>I<sup>2</sup>C-bus pins (P0[2] and P0[3])</b>						
$t_f$	fall time	$V_{IH}$ to $V_{IL}$	<sup>[2]</sup> $20 + 0.1 \times C_b$	-	-	ns

[1] Parameters are valid over operating temperature range unless otherwise specified.

[2] Bus capacitance  $C_b$  in pF, from 10 pF to 400 pF.

## 9.1 Timing

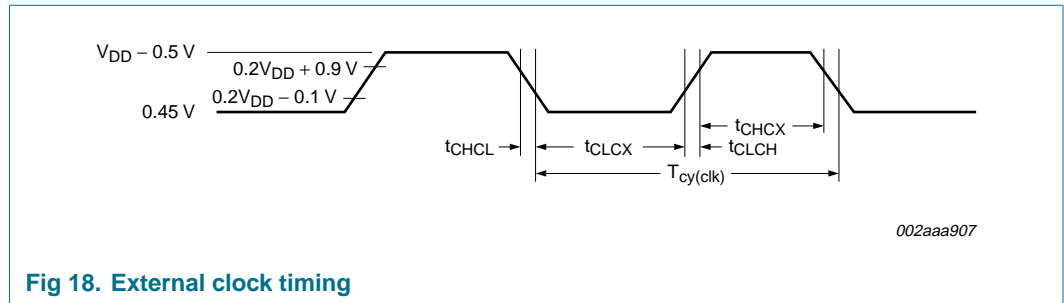

10. Package outline

LQFP64: plastic low profile quad flat package; 64 leads; body 10 x 10 x 1.4 mm

SOT314-2

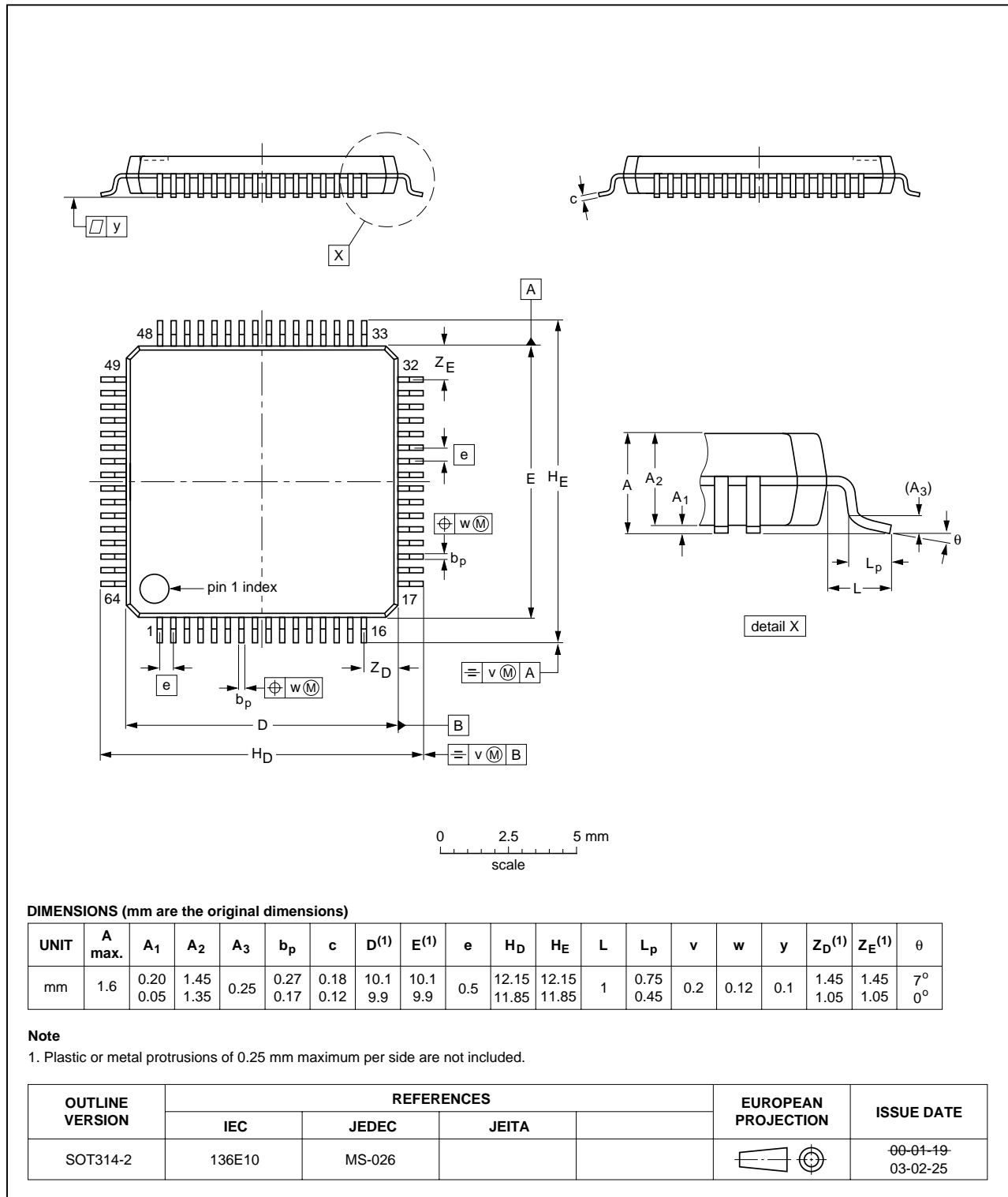

Fig 19. Package outline SOT314-2 (LQFP64)



## 11. Abbreviations

**Table 11. Abbreviations**

Acronym	Description
ADC	Analog-to-Digital Converter
AMBA	Advanced Microcontroller Bus Architecture
APB	Advanced Peripheral Bus
CAN	Controller Area Network
CPU	Central Processing Unit
DCC	Debug Communications Channel
FIFO	First In, First Out
GPIO	General Purpose Input/Output
I/O	Input/Output
PLL	Phase-Locked Loop
PWM	Pulse Width Modulator
RAM	Random Access Memory
SPI	Serial Peripheral Interface
SRAM	Static Random Access Memory
SSI	Synchronous Serial Interface
SSP	Synchronous Serial Port
TTL	Transistor-Transistor Logic
UART	Universal Asynchronous Receiver/Transmitter

## 12. Revision history

**Table 12. Revision history**

Document ID	Release date	Data sheet status	Change notice	Supersedes
LPC2109_2119_2129_6	20071210	Product data sheet	-	LPC2109_2119_2129_5
Modifications:		<ul style="list-style-type: none"> <li>• Type number LPC2109FBD64/01 has been added.</li> <li>• Type number LPC2119FBD64/01 has been added.</li> <li>• Type number LPC2129FBD64/01 has been added.</li> <li>• Details introduced with /01 devices on new peripherals/features (Fast I/O Ports, SSP, CRP) and enhancements to existing ones (UART0/1, Timers, ADC, and SPI) have been added.</li> <li>• Power measurements for LPC2109/2119/2129/01 devices have been added.</li> <li>• Description of JTAG pin TCK has been updated.</li> </ul>		
LPC2109_2119_2129_5	20070627	Product data sheet	-	LPC2119_2129_4
LPC2119_2129_4	20060714	Product data sheet	-	LPC2119_2129-03
LPC2119_2129-03	20041222	Product data	-	LPC2119_2129-02
LPC2119_2129-02	20040202	Preliminary data	-	LPC2119_2129-01
LPC2119_2129-01	20031118	Preliminary data	-	-

## 13. Legal information

### 13.1 Data sheet status

Document status <sup>[1][2]</sup>	Product status <sup>[3]</sup>	Definition
Objective [short] data sheet	Development	This document contains data from the objective specification for product development.
Preliminary [short] data sheet	Qualification	This document contains data from the preliminary specification.
Product [short] data sheet	Production	This document contains the product specification.

[1] Please consult the most recently issued document before initiating or completing a design.

[2] The term 'short data sheet' is explained in section "Definitions".

[3] The product status of device(s) described in this document may have changed since this document was published and may differ in case of multiple devices. The latest product status information is available on the Internet at URL <http://www.nxp.com>.

### 13.2 Definitions

**Draft** — The document is a draft version only. The content is still under internal review and subject to formal approval, which may result in modifications or additions. NXP Semiconductors does not give any representations or warranties as to the accuracy or completeness of information included herein and shall have no liability for the consequences of use of such information.

**Short data sheet** — A short data sheet is an extract from a full data sheet with the same product type number(s) and title. A short data sheet is intended for quick reference only and should not be relied upon to contain detailed and full information. For detailed and full information see the relevant full data sheet, which is available on request via the local NXP Semiconductors sales office. In case of any inconsistency or conflict with the short data sheet, the full data sheet shall prevail.

### 13.3 Disclaimers

**General** — Information in this document is believed to be accurate and reliable. However, NXP Semiconductors does not give any representations or warranties, expressed or implied, as to the accuracy or completeness of such information and shall have no liability for the consequences of use of such information.

**Right to make changes** — NXP Semiconductors reserves the right to make changes to information published in this document, including without limitation specifications and product descriptions, at any time and without notice. This document supersedes and replaces all information supplied prior to the publication hereof.

**Suitability for use** — NXP Semiconductors products are not designed, authorized or warranted to be suitable for use in medical, military, aircraft, space or life support equipment, nor in applications where failure or malfunction of an NXP Semiconductors product can reasonably be expected

to result in personal injury, death or severe property or environmental damage. NXP Semiconductors accepts no liability for inclusion and/or use of NXP Semiconductors products in such equipment or applications and therefore such inclusion and/or use is at the customer's own risk.

**Applications** — Applications that are described herein for any of these products are for illustrative purposes only. NXP Semiconductors makes no representation or warranty that such applications will be suitable for the specified use without further testing or modification.

**Limiting values** — Stress above one or more limiting values (as defined in the Absolute Maximum Ratings System of IEC 60134) may cause permanent damage to the device. Limiting values are stress ratings only and operation of the device at these or any other conditions above those given in the Characteristics sections of this document is not implied. Exposure to limiting values for extended periods may affect device reliability.

**Terms and conditions of sale** — NXP Semiconductors products are sold subject to the general terms and conditions of commercial sale, as published at <http://www.nxp.com/profile/terms>, including those pertaining to warranty, intellectual property rights infringement and limitation of liability, unless explicitly otherwise agreed to in writing by NXP Semiconductors. In case of any inconsistency or conflict between information in this document and such terms and conditions, the latter will prevail.

**No offer to sell or license** — Nothing in this document may be interpreted or construed as an offer to sell products that is open for acceptance or the grant, conveyance or implication of any license under any copyrights, patents or other industrial or intellectual property rights.

### 13.4 Trademarks

Notice: All referenced brands, product names, service names and trademarks are the property of their respective owners.

**I<sup>2</sup>C-bus** — logo is a trademark of NXP B.V.

## 14. Contact information

For additional information, please visit: <http://www.nxp.com>

For sales office addresses, send an email to: [salesaddresses@nxp.com](mailto:salesaddresses@nxp.com)

## 15. Contents

<b>1</b>	<b>General description</b> . . . . .	<b>1</b>	6.15	Watchdog timer	18
<b>2</b>	<b>Features</b> . . . . .	<b>1</b>	6.15.1	Features	18
2.1	Key features brought by LPC2109/2119/2129/01 devices	1	6.16	Real-time clock	19
2.2	Key features common for all devices	1	6.16.1	Features	19
<b>3</b>	<b>Ordering information</b> . . . . .	<b>2</b>	6.17	Pulse width modulator	19
3.1	Ordering options	3	6.17.1	Features	20
<b>4</b>	<b>Block diagram</b> . . . . .	<b>4</b>	6.18	System control	20
<b>5</b>	<b>Pinning information</b> . . . . .	<b>5</b>	6.18.1	Crystal oscillator	20
5.1	Pinning	5	6.18.2	PLL	21
5.2	Pin description	6	6.18.3	Reset and wake-up timer	21
<b>6</b>	<b>Functional description</b> . . . . .	<b>10</b>	6.18.4	Code security (Code Read Protection - CRP)	21
6.1	Architectural overview	10	6.18.5	External interrupt inputs	22
6.2	On-chip flash program memory	10	6.18.6	Memory mapping control	22
6.3	On-chip static RAM	11	6.18.7	Power control	22
6.4	Memory map	11	6.18.8	APB	23
6.5	Interrupt controller	12	6.19	Emulation and debugging	23
6.5.1	Interrupt sources	13	6.19.1	EmbeddedICE	23
6.6	Pin connect block	14	6.19.2	Embedded trace macrocell	23
6.7	General purpose parallel I/O (GPIO) and Fast I/O	14	6.19.3	RealMonitor	24
6.7.1	Features	14	<b>7</b>	<b>Limiting values</b>	<b>25</b>
6.7.2	Features added with the Fast GPIO set of registers available on LPC2109/2119/2129/01 only	14	<b>8</b>	<b>Static characteristics</b>	<b>26</b>
6.8	10-bit ADC	15	8.1	Power consumption measurements for LPC2109/01, LPC2119/01, LPC2129/01 devices	30
6.8.1	Features	15	<b>9</b>	<b>Dynamic characteristics</b>	<b>38</b>
6.8.2	ADC features available in LPC2109/2119/2129/01 only	15	9.1	Timing	39
6.9	CAN controllers and acceptance filter	15	<b>10</b>	<b>Package outline</b>	<b>40</b>
6.9.1	Features	15	<b>11</b>	<b>Abbreviations</b>	<b>41</b>
6.10	UARTs	15	<b>12</b>	<b>Revision history</b>	<b>42</b>
6.10.1	Features	15	<b>13</b>	<b>Legal information</b>	<b>43</b>
6.10.2	UART features available in LPC2109/2119/2129/01 only	16	13.1	Data sheet status	43
6.11	I <sup>2</sup> C-bus serial I/O controller	16	13.2	Definitions	43
6.11.1	Features	16	13.3	Disclaimers	43
6.12	SPI serial I/O controller	17	13.4	Trademarks	43
6.12.1	Features	17	<b>14</b>	<b>Contact information</b>	<b>43</b>
6.12.2	Features available in LPC2109/2119/2129/01 only	17	<b>15</b>	<b>Contents</b>	<b>44</b>
6.13	SSP controller (LPC2109/2119/2129/01 only)	17			
6.13.1	Features	17			
6.14	General purpose timers	17			
6.14.1	Features	18			
6.14.2	Features available in LPC2109/2119/2129/01 only	18			

Please be aware that important notices concerning this document and the product(s) described herein, have been included in section 'Legal information'.

founded by



© NXP B.V. 2007.

All rights reserved.

For more information, please visit: <http://www.nxp.com>For sales office addresses, please send an email to: [salesaddresses@nxp.com](mailto:salesaddresses@nxp.com)

Date of release: 10 December 2007

Document identifier: LPC2109\_2119\_2129\_6