

### FAST RECOVERY DIODES

### Hockey Puk Version

#### Features

- High power FAST recovery diode series
- 2.0 to 3.0  $\mu$ s recovery time
- High voltage ratings up to 3000V
- High current capability
- Optimized turn on and turn off characteristics
- Low forward recovery
- Fast and soft reverse recovery
- Press-puk encapsulation
- Case style conform to JEDEC DO-200AB (B-PUK)
- Maximum junction temperature 150°C

#### Typical Applications

- Snubber diode for GTO
- High voltage free-wheeling diode
- Fast recovery rectifier applications

920A  
1050A

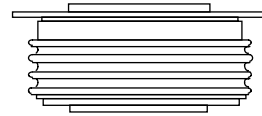

case style DO-200AB (B-PUK)

#### Major Ratings and Characteristics

Parameters	SD1053C..L		Units
	S20	S30	
$I_{F(AV)}$	1050	920	A
@ $T_{hs}$	55	55	°C
$I_{F(RMS)}$	1940	1700	A
$I_{FSM}$ @ 50Hz	15000	13000	A
@ 60Hz	15700	13610	A
$V_{RRM}$ range	1800 to 2500	1800 to 3000	V
$t_{rr}$	2.0	3.0	$\mu$ s
@ $T_J$	25	25	°C
$T_J$	- 40 to 150		°C

## SD1053C..L Series

Bulletin I2079 rev. B 04/00

International  
 Rectifier

### ELECTRICAL SPECIFICATIONS

#### Voltage Ratings

Type number	Voltage Code	$V_{RRM}$ , maximum repetitive peak reverse voltage V	$V_{RSM}$ , maximum non-repetitive peak rev. voltage V	$I_{RRM}$ max. @ $T_J = T_J$ max. mA
SD1053C..S20L	18	1800	1900	50
	22	2200	2300	
	25	2500	2600	
SD1053C..S30L	18	1800	1900	
	22	2200	2300	
	25	2500	2600	
	28	2800	2900	
	30	3000	3100	

#### Forward Conduction

Parameter	SD1053C..L		Units	Conditions		
	S20	S30				
$I_{F(AV)}$ Max. average forward current @ heatsink temperature	1050(450)	920(390)	A	180° conduction, half sine wave		
	55 (85)	55 (85)	°C	Double side (single side) cooled		
$I_{F(RMS)}$ Max. RMS forward current	1940	1700	A	@ 25°C heatsink temperature double side cooled		
$I_{FSM}$ Max. peak, one-cycle forward, non-repetitive surge current	15000	13000	A	t = 10ms	No voltage	Sinusoidal half wave, Initial $T_J = T_J$ max.
	15700	13610		t = 8.3ms	reapplied	
	12620	10930		t = 10ms	100% $V_{RRM}$	
	13210	11450		t = 8.3ms	reapplied	
$I^2t$ Maximum $I^2t$ for fusing	1125	845	KA <sup>2</sup> s	t = 10ms	No voltage	
	1027	772		t = 8.3ms	reapplied	
	796	598		t = 10ms	100% $V_{RRM}$	
	727	546		t = 8.3ms	reapplied	
$I^2\sqrt{t}$ Maximum $I^2\sqrt{t}$ for fusing	11250	8450	KA <sup>2</sup> /s	t = 0.1 to 10ms, no voltage reapplied		
$V_{F(TO)1}$ Low level value of threshold voltage	1.34	1.51	V	(16.7% x $\pi$ x $I_{F(AV)}$ ) < I < $\pi$ x $I_{F(AV)}$ , $T_J = T_J$ max.		
$V_{F(TO)2}$ High level value of threshold voltage	1.48	1.67		(I > $\pi$ x $I_{F(AV)}$ ), $T_J = T_J$ max.		
$r_{f1}$ Low level value of forward slope resistance	0.37	0.50	mΩ	(16.7% x $\pi$ x $I_{F(AV)}$ ) < I < $\pi$ x $I_{F(AV)}$ , $T_J = T_J$ max.		
$r_{f2}$ High level value of forward slope resistance	0.33	0.45		(I > $\pi$ x $I_{F(AV)}$ ), $T_J = T_J$ max.		
$V_{FM}$ Max. forward voltage drop	1.90	2.26	V	$I_{pk} = 1500A$ , $T_J = T_J$ max, $t_p = 10ms$ sinusoidal wave		

**Recovery Characteristics**

Code	$T_J = 25^\circ\text{C}$ Typical $t_{rr}$ @ 25% $I_{RRM}$ ( $\mu\text{s}$ )	Test conditions			Max. values @ $T_J = 150^\circ\text{C}$		
		$I_{pk}$ Square Pulse (A)	$di/dt$ (A/ $\mu\text{s}$ )	$V_r$ (V)	$t_{rr}$ @ 25% $I_{RRM}$ ( $\mu\text{s}$ )	$Q_{rr}$ ( $\mu\text{C}$ )	$I_{rr}$ (A)
S20	2.0	1000	100	-50	4.0	400	180
S30	3.0	1000	100	-50	4.5	550	230

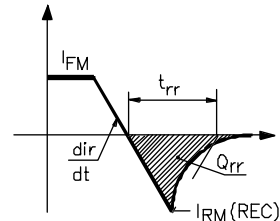

**Thermal and Mechanical Specifications**

Parameter	SD1053C..L		Units	Conditions
	S20	S30		
$T_J$ Max. junction operating temperature range	-40 to 150		°C	
$T_{stg}$ Max. storage temperature range	-40 to 150			
$R_{thJ-hs}$ Max. thermal resistance, case junction to heatsink	0.073	0.031	K/W	DCoperation single side cooled DCoperation double side cooled
F Mounting force, $\pm 10\%$	14700 (1500)		N (Kg)	
wt Approximate weight	255		g	
Case style	DO-200AB(B-PUK)			See Outline Table

**$\Delta R_{thJ-hs}$  Conduction**

(The following table shows the increment of thermal resistance  $R_{thJ-hs}$  when devices operate at different conduction angles than DC)

Conduction angle	Sinusoidal conduction		Rectangular conduction		Units	Conditions
	Single Side	Double Side	Single Side	Double Side		
180°	0.009	0.008	0.006	0.006	K/W	$T_J = T_J \text{ max.}$
120°	0.011	0.011	0.011	0.011		
90°	0.014	0.014	0.015	0.015		
60°	0.020	0.021	0.021	0.022		
30°	0.036	0.036	0.036	0.036		

**Ordering Information Table**

Device Code							
SD	105	3	C	30	S30	L	
①	②	③	④	⑤	⑥	⑦	
<b>1</b>	- Diode	<b>2</b>	- Essential part number	<b>3</b>	- 3 = Fast recovery	<b>4</b>	- C = Ceramic Puk
<b>5</b>	- Voltage code: Code x 100 = $V_{RRM}$ (See Voltage Ratings table)	<b>6</b>	- $t_{rr}$ code	<b>7</b>	- L = Puk Case DO-200AB(B-PUK)		

**SD1053C..L Series**

Bulletin I2079 rev. B 04/00

Outline Table

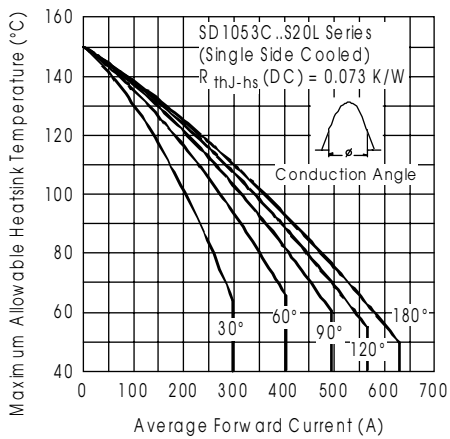
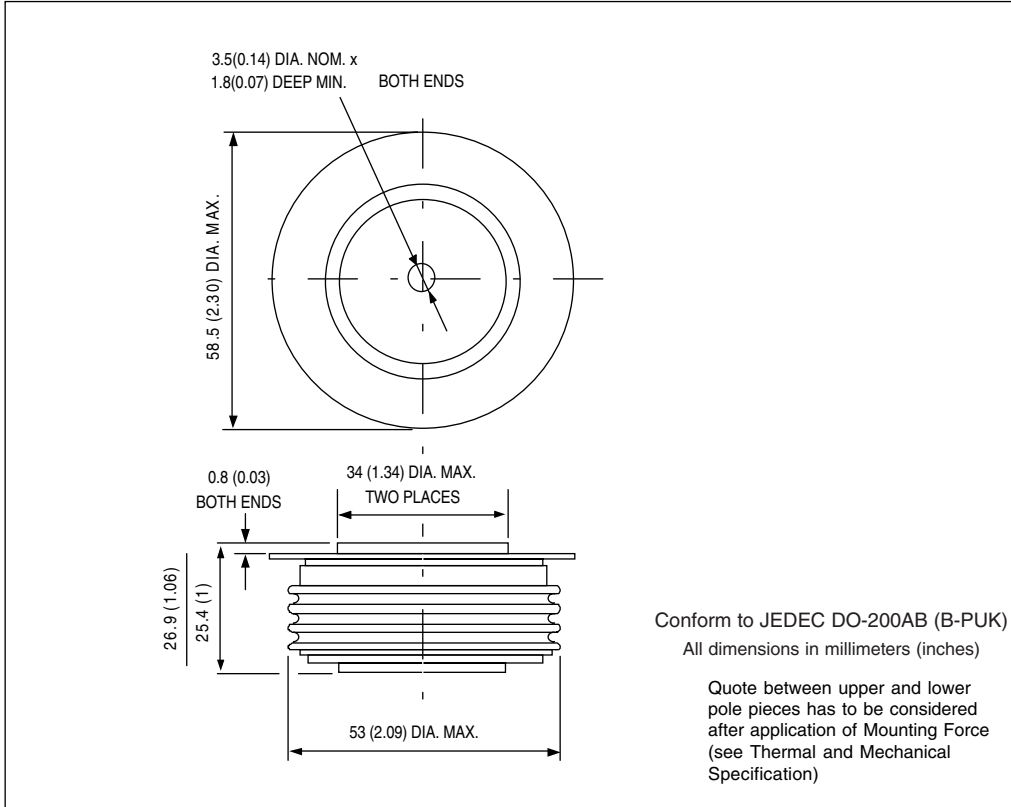

Fig. 1 - Current Ratings Characteristics

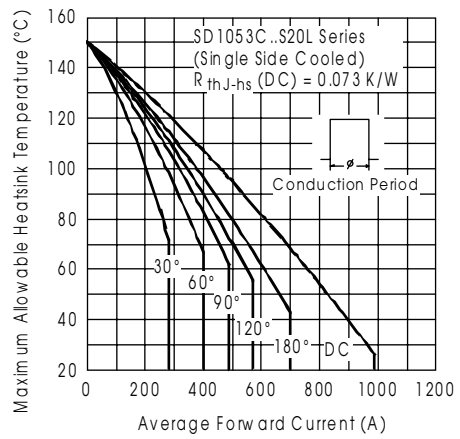

Fig. 2 - Current Ratings Characteristics

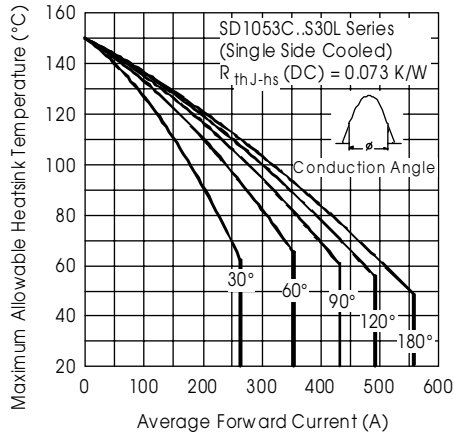

Fig. 3 - Current Ratings Characteristics

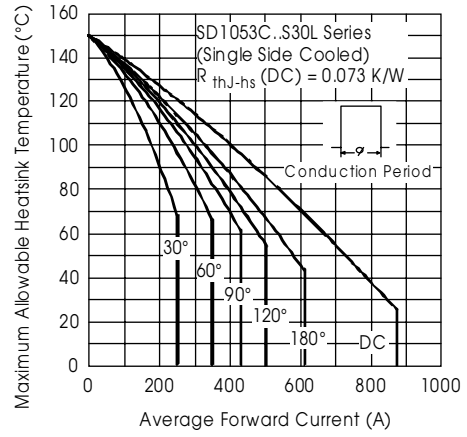

Fig. 4 - Current Ratings Characteristics

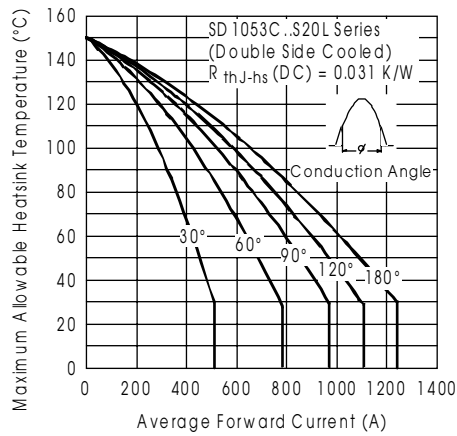

Fig. 5 - Current Ratings Characteristics

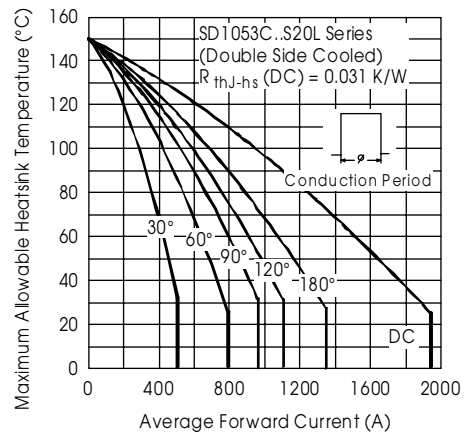

Fig. 6 - Current Ratings Characteristics

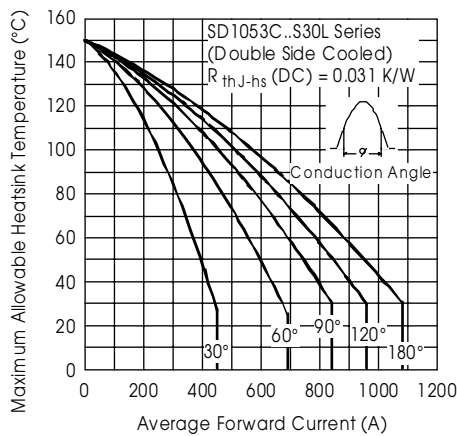

Fig. 7 - Current Ratings Characteristics

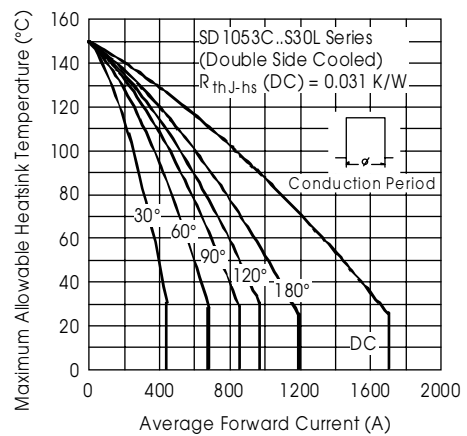

Fig. 8 - Current Ratings Characteristics

**SD1053C..L Series**

Bulletin I2079 rev. B 04/00

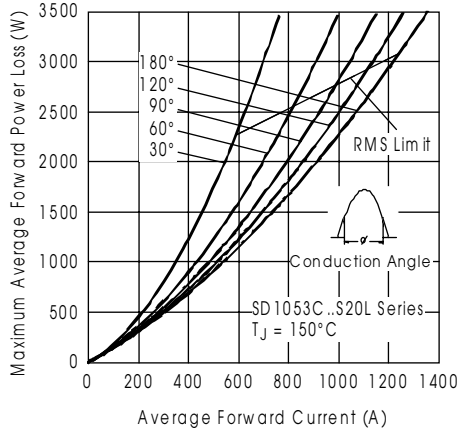

Fig. 9 - Forward Power Loss Characteristics

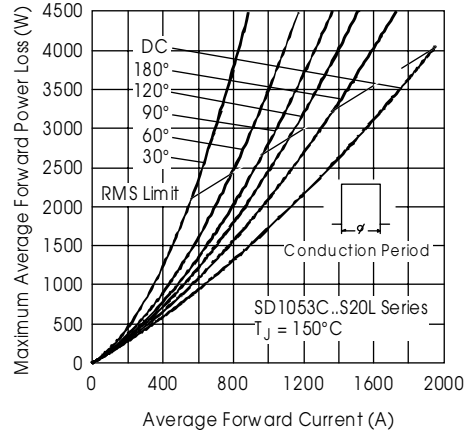

Fig. 10 - Forward Power Loss Characteristics

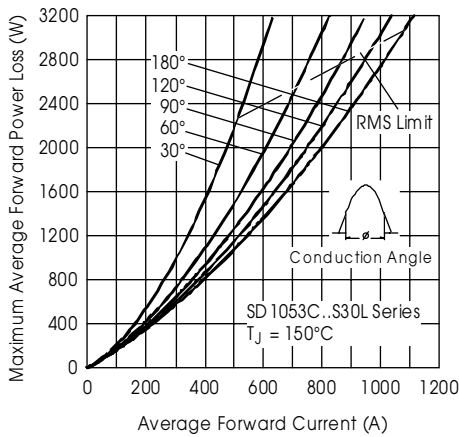

Fig. 11 - Forward Power Loss Characteristics

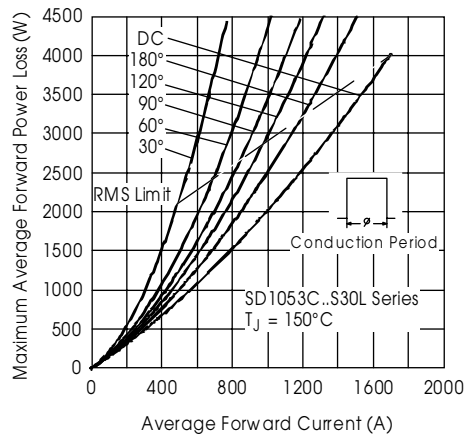

Fig. 12 - Forward Power Loss Characteristics

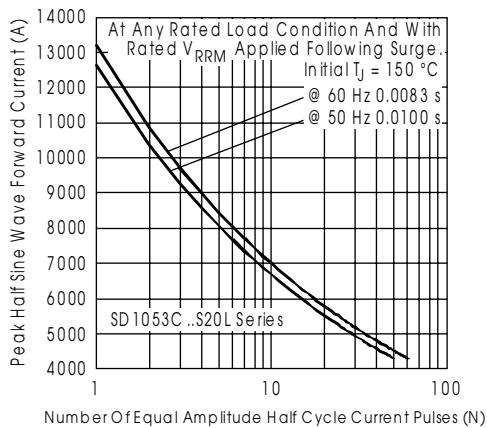

Fig. 13 - Maximum Non-repetitive Surge Current Single and Double Side Cooled

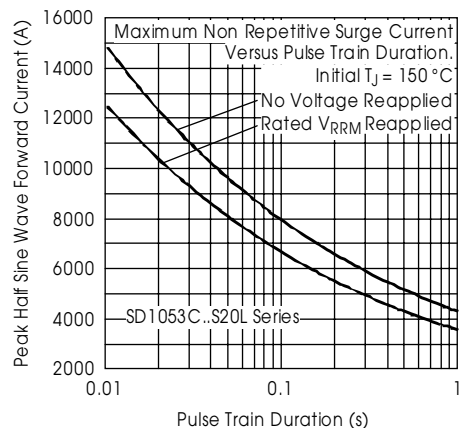

Fig. 14 - Maximum Non-repetitive Surge Current Single and Double Side Cooled

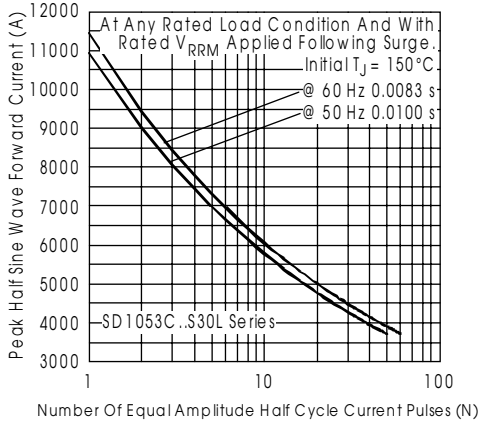

Fig. 15 - Maximum Non-repetitive Surge Current Single and Double Side Cooled

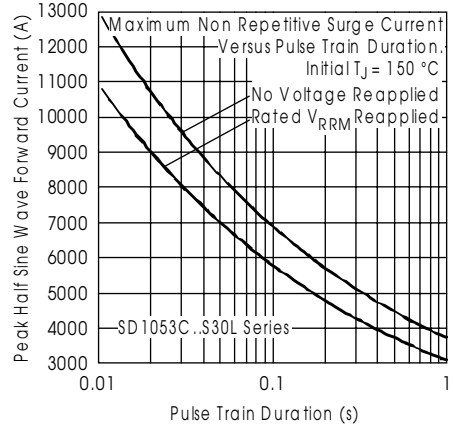

Fig. 16 - Maximum Non-repetitive Surge Current Single and Double Side Cooled

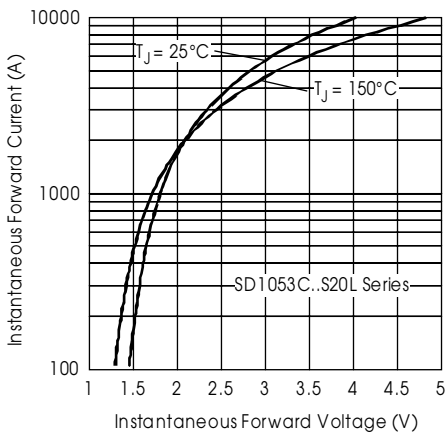

Fig. 17 - Forward Voltage Drop Characteristics

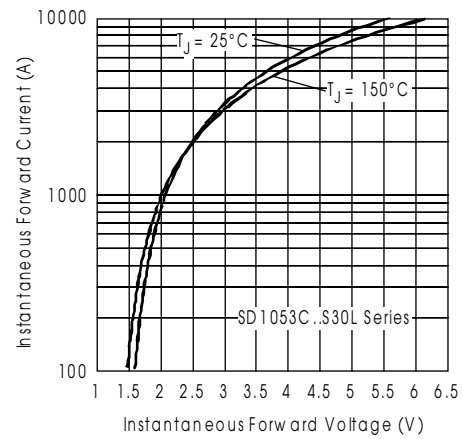

Fig. 18 - Forward Voltage Drop Characteristics

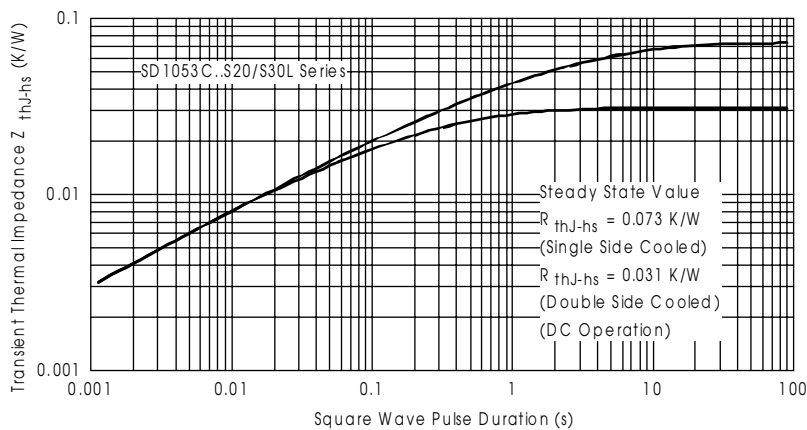

Fig. 19 - Thermal Impedance  $Z_{thJ-hs}$  Characteristic

# SD1053C..L Series

Bulletin I2079 rev. B 04/00

International  
**IR** Rectifier

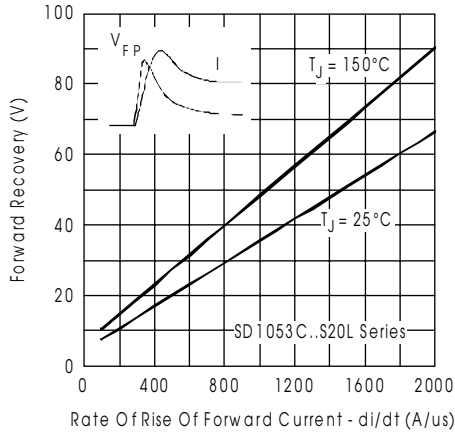

Fig. 20 - Typical Forward Recovery Characteristics

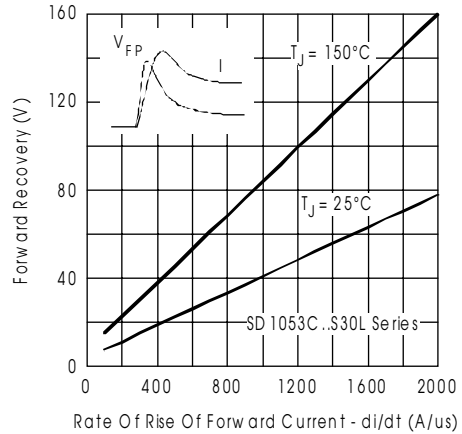

Fig. 21 - Typical Forward Recovery Characteristics

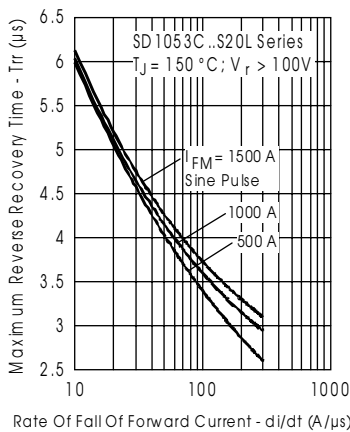

Fig. 22 - Recovery Time Characteristics

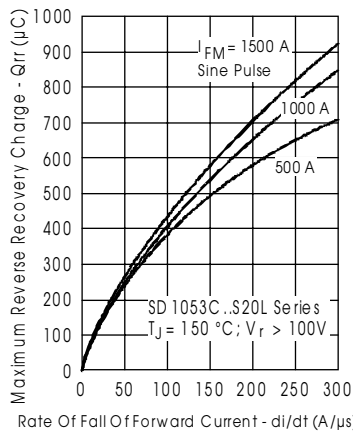

Fig. 23 - Recovery Charge Characteristics

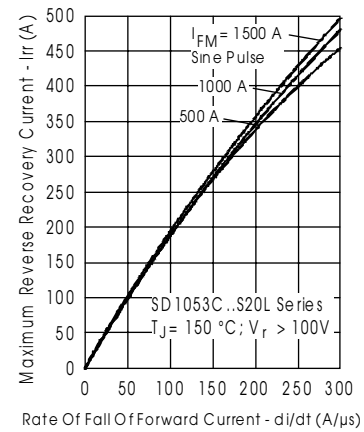

Fig. 24 - Recovery Current Characteristics

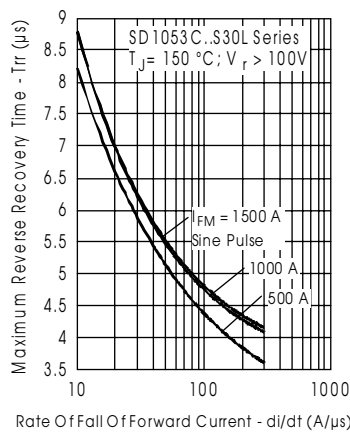

Fig. 25 - Recovery Time Characteristics

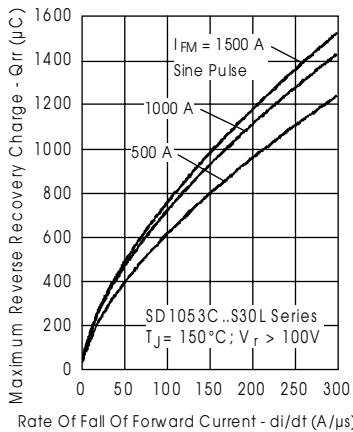

Fig. 26 - Recovery Charge Characteristics

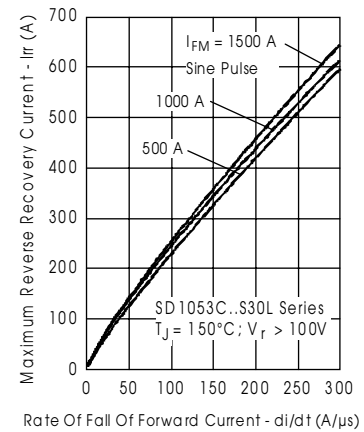

Fig. 27 - Recovery Current Characteristics



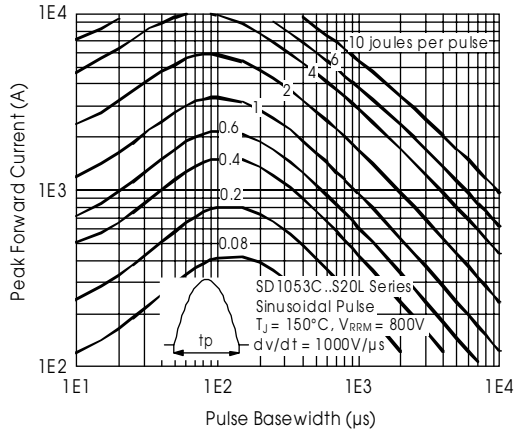

Fig. 28 - Maximum Total Energy Loss Per Pulse Characteristics

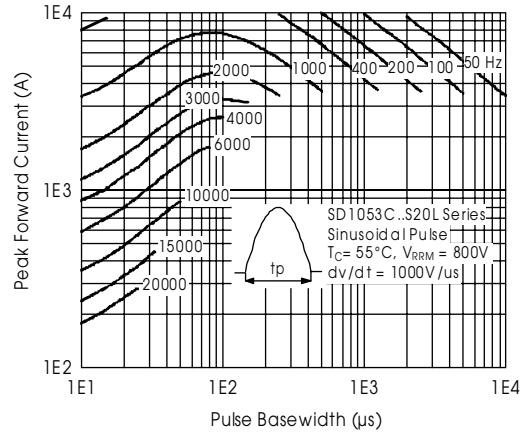

Fig. 29 - Frequency Characteristics

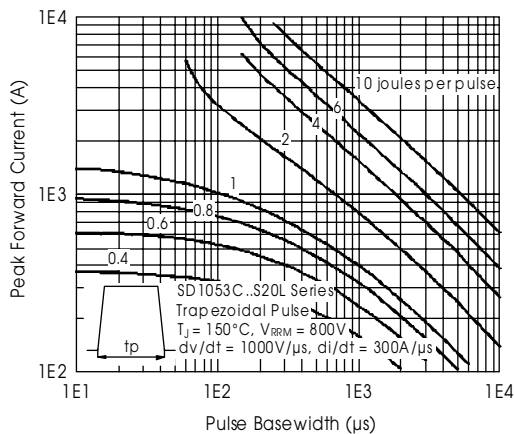

Fig. 30 - Maximum Total Energy Loss Per Pulse Characteristics

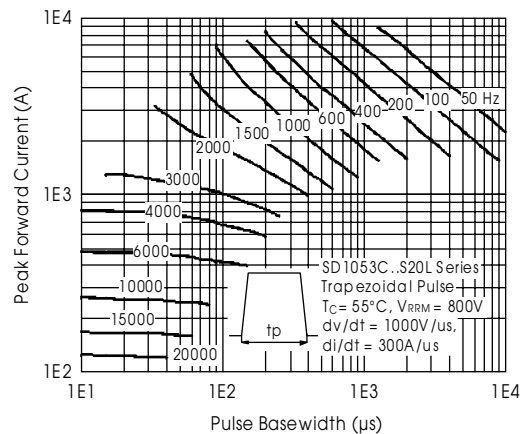

Fig. 31 - Frequency Characteristics

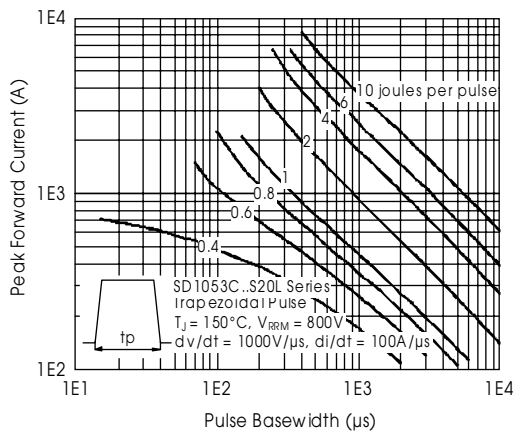

Fig. 32 - Maximum Total Energy Loss Per Pulse Characteristics

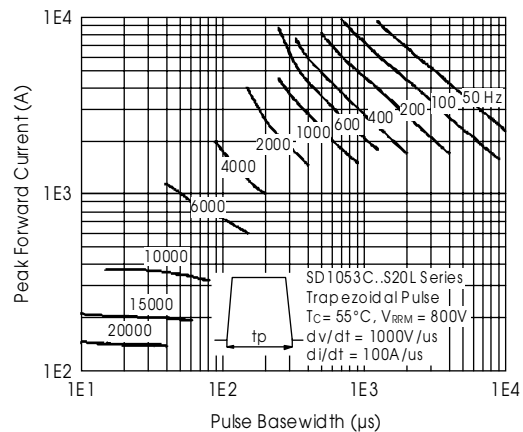

Fig. 33 - Frequency Characteristics

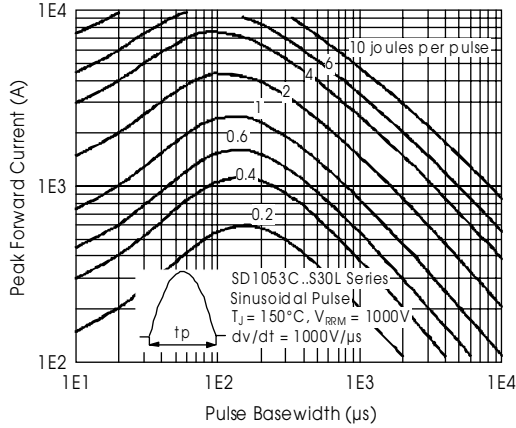

Fig. 34 - Maximum Total Energy Loss Per Pulse Characteristics

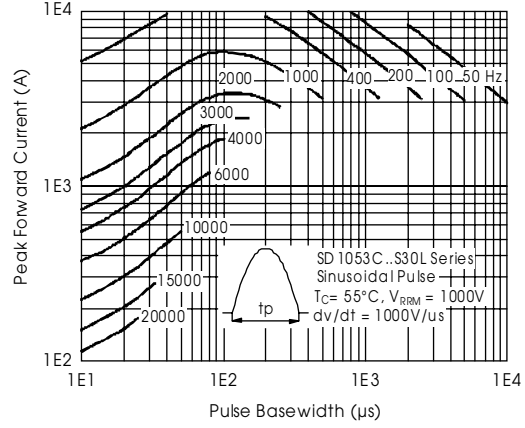

Fig. 35 - Frequency Characteristics

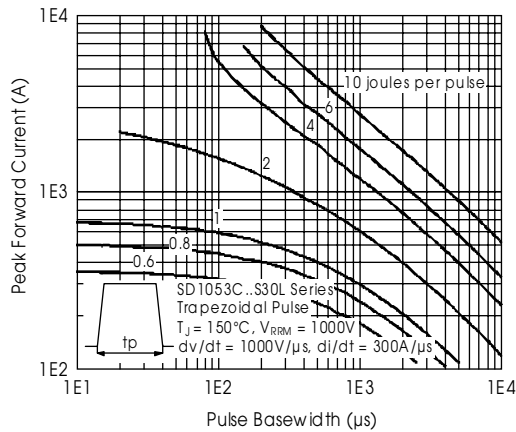

Fig. 36 - Maximum Total Energy Loss Per Pulse Characteristics

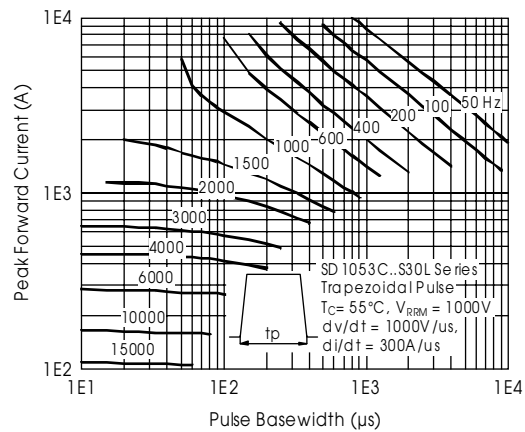

Fig. 37 - Frequency Characteristics

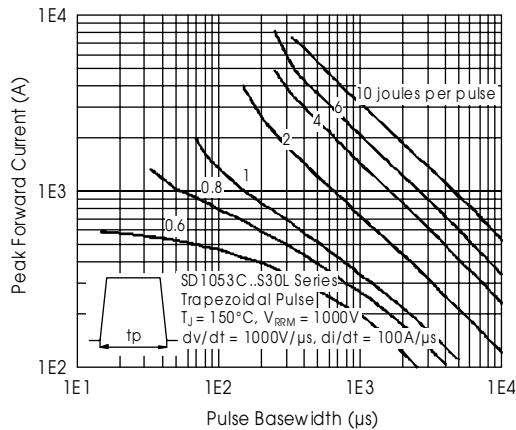

Fig. 38 - Maximum Total Energy Loss Per Pulse Characteristics

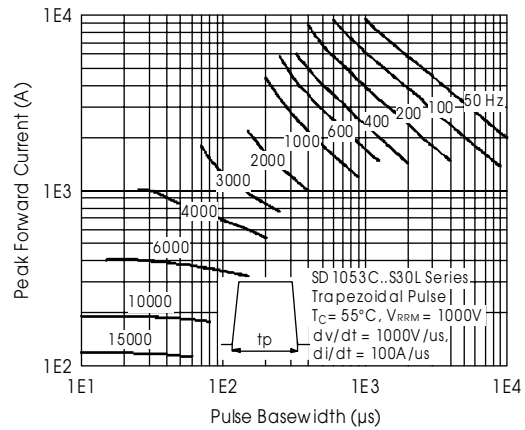

Fig. 39 - Frequency Characteristics