

ELECTROSTATIC SENSITIVE DEVICE
OBSERVE HANDLING PRECAUTIONS

RD04HMS2

RoHS Compliance, Silicon MOSFET Power Transistor, 175MHz, 950MHz, 4W

DESCRIPTION

RD04HMS2 is MOS FET type transistor specifically designed for VHF/UHF/890-950MHz RF power amplifiers applications.

FEATURES

- High Power gain and High Efficiency
Pout=5.0Wtyp., Gp=14dBtyp.
Drain Effi.=53%typ.
@Vds=12.5V, Pin=0.2W, f=950MHz
- Integrated gate protection diode

APPLICATION

For output stage of high power amplifiers in VHF/UHF/890-950MHz band mobile radio sets.

RoHS COMPLIANT

RD04HMS2 is a RoHS compliant product. RoHS compliance is indicating by the letter "G" after the Lot Marking. This product includes the lead in high melting temperature type solders. However, it is applicable to the following exceptions of RoHS Directions.

- Lead in high melting temperature type solders (i.e. tin-lead solder alloys containing more than 85% lead.)

ABSOLUTE MAXIMUM RATINGS (Tc=25°C UNLESS OTHERWISE NOTED)

SYMBOL	PARAMETER	CONDITIONS	RATINGS	UNIT
VDSS	Drain to Source Voltage	Vgs=0V	40	V
VGSS	Gate to Source Voltage	Vds=0V	-5/+10	V
Pch	Channel Dissipation	Tc=25°C	50	W
Pin	Input Power	Zg=Zl=50Ω	0.7	W
ID	Drain Current	-	3	A
Tch	Junction Temperature	-	150	°C
Tstg	Storage Temperature	-	-40 to +125	°C
Rth j-c	Thermal Resistance	Junction to Case	2.5	°C/W

Note: Above parameters are guaranteed independently.

ELECTRICAL CHARACTERISTICS (Tc=25°C, UNLESS OTHERWISE NOTED)

SYMBOL	PARAMETER	CONDITIONS	LIMITS			UNIT
			MIN	TYP	MAX.	
IDSS	Zero Gate Voltage Drain Current	VDS=37V, VGS=0V	-	-	5	μA
IGSS	Gate to Source Leak Current	VGS=10V, VDS=0V	-	-	2.5	μA
VTH	Gate Threshold Voltage	VDS=12V, IDS=1mA	1.6	-	2.6	V
Pout1	Output power	f=950MHz*, VDS=12.5V,	-	5.0	-	W
ηD1	Drain Efficiency	Pin=0.2W, Idq=0.1A	-	58	-	%
Pout2	Output Power	f=175MHz**, VDS=12.5V,	-	5.5	-	W
ηD2	Drain Efficiency	Pin=0.2W, Idq=0.1A	-	73	-	%
VSWR	Load VSWR Tolerance	VDS=15.2V, Po=4W (Pin:Control) f=135MHz, Idq=0.1A, Zg=50Ω Zl=All phase	20:1	-	-	VSWR

Note: Above parameters, ratings, limits and conditions are subject to change.

* In Mitsubishi 890-950MHz Evaluation Board ** In Mitsubishi VHF Evaluation Board

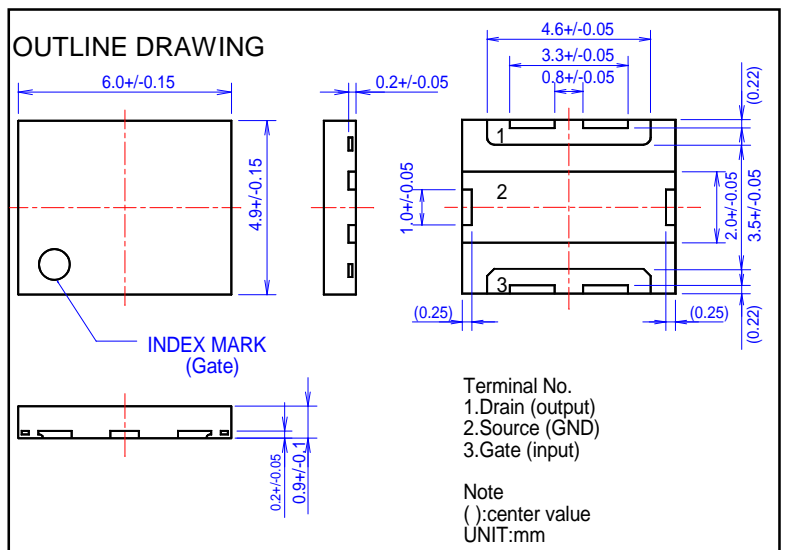

ELECTROSTATIC SENSITIVE DEVICE
OBSERVE HANDLING PRECAUTIONS

RD04HMS2

RoHS Compliance, Silicon MOSFET Power Transistor, 175MHz, 950MHz, 4W

TYPICAL CHARACTERISTICS

(These are only typical curves and devices are not necessarily guaranteed at these curves.)

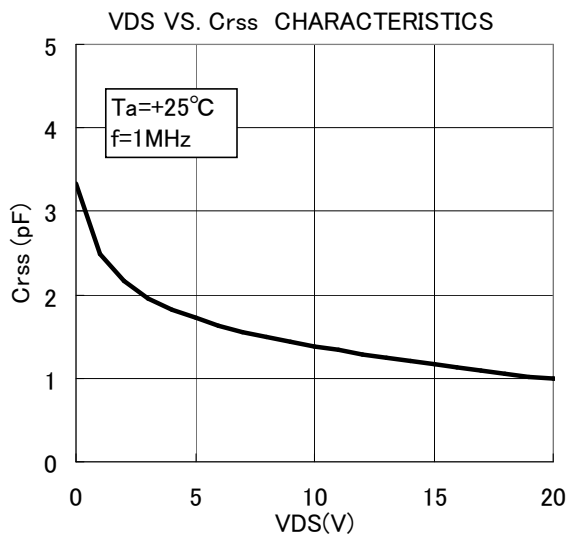
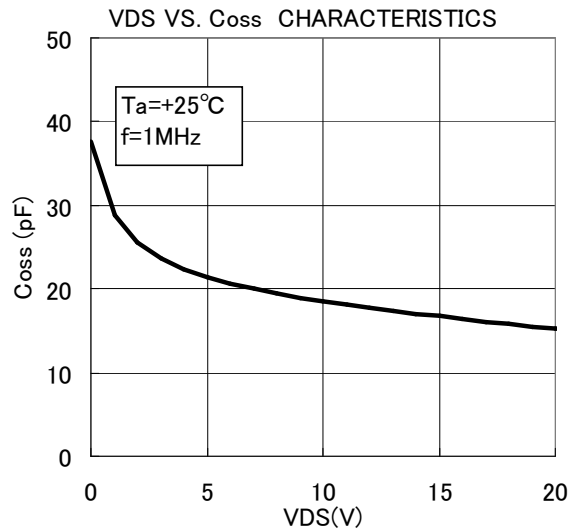
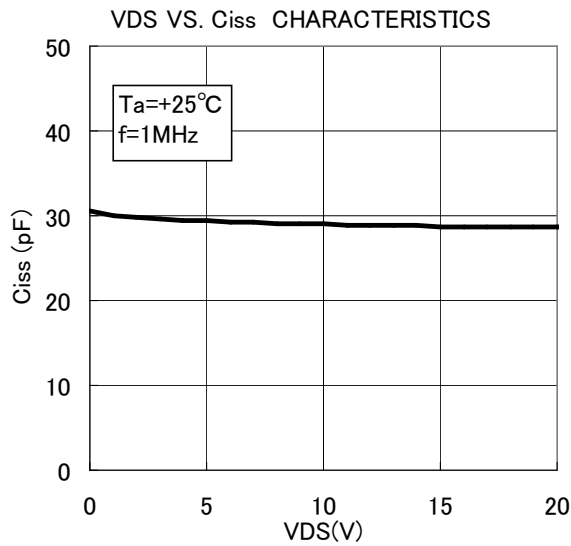
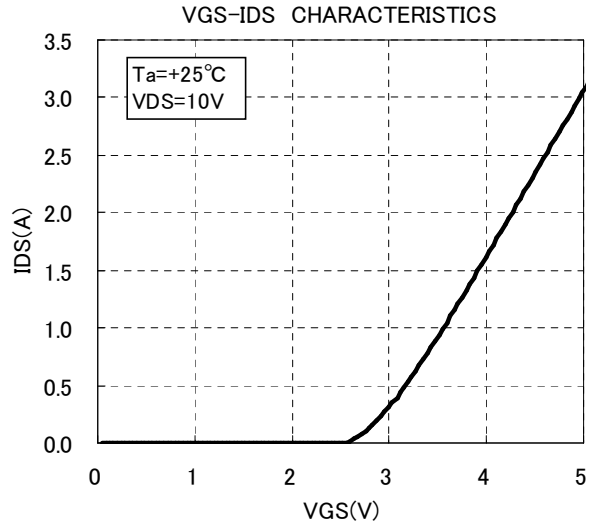
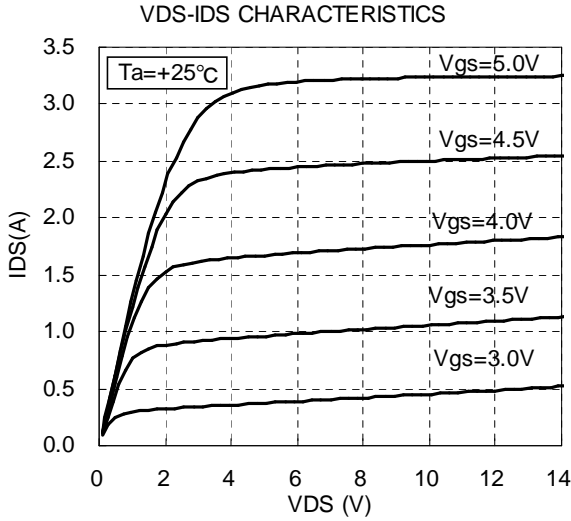

ELECTROSTATIC SENSITIVE DEVICE
OBSERVE HANDLING PRECAUTIONS

RD04HMS2

RoHS Compliance, Silicon MOSFET Power Transistor, 175MHz, 950MHz, 4W

VHF-band TYPICAL CHARACTERISTICS

(These are only typical curves and devices are not necessarily guaranteed at these curves.)

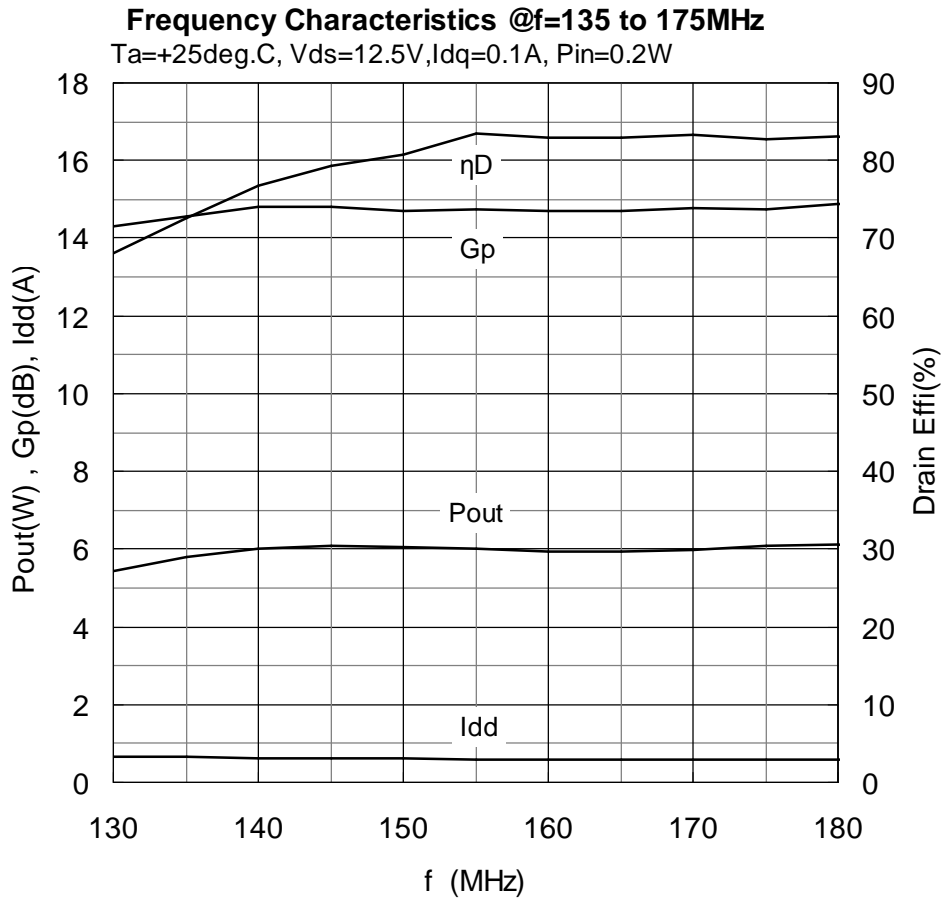

ELECTROSTATIC SENSITIVE DEVICE
OBSERVE HANDLING PRECAUTIONS

RD04HMS2

RoHS Compliance, Silicon MOSFET Power Transistor, 175MHz, 950MHz, 4W

VHF-band TYPICAL CHARACTERISTICS

(These are only typical curves and devices are not necessarily guaranteed at these curves.)

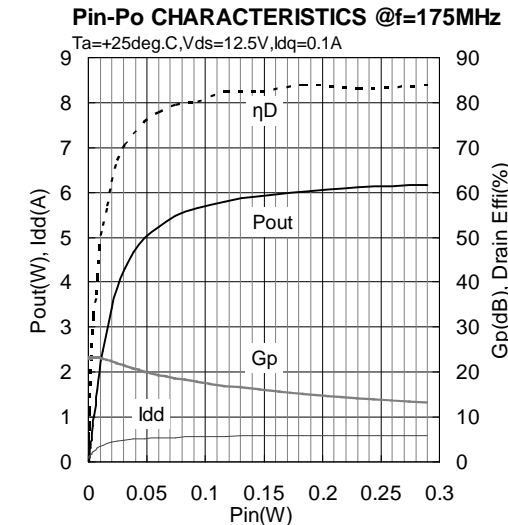
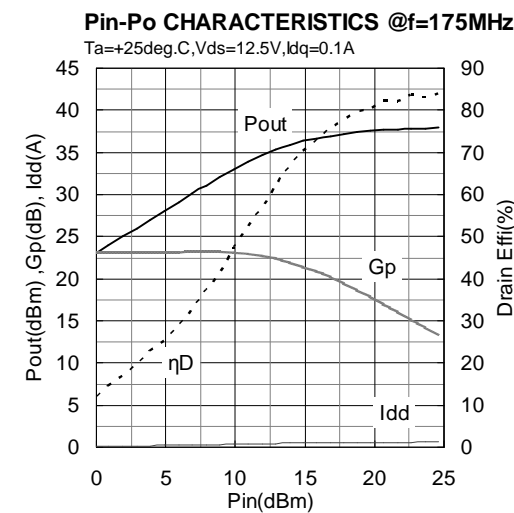
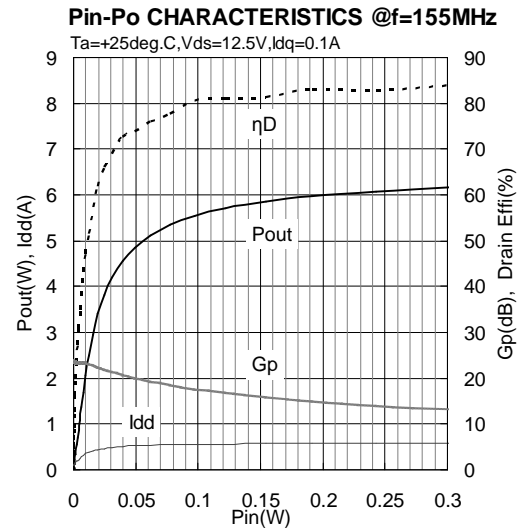
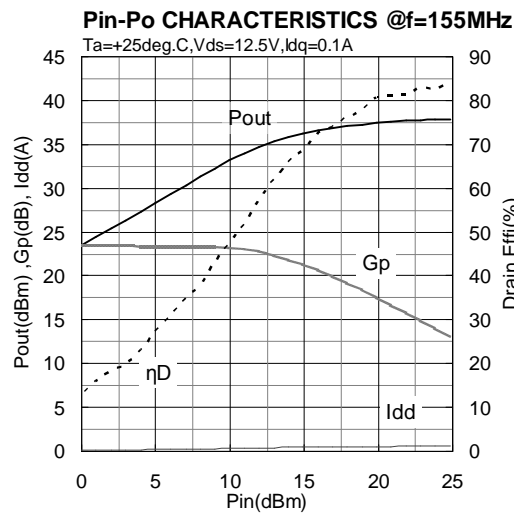
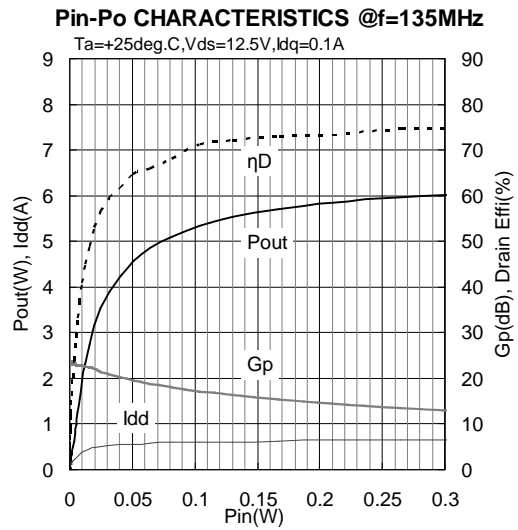
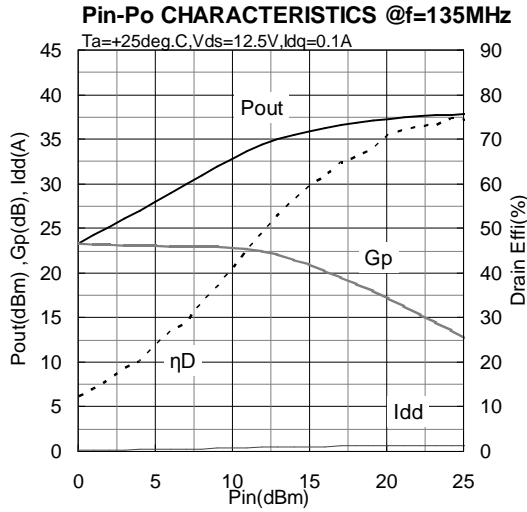

ELECTROSTATIC SENSITIVE DEVICE
OBSERVE HANDLING PRECAUTIONS

RD04HMS2

RoHS Compliance, Silicon MOSFET Power Transistor, 175MHz, 950MHz, 4W

VHF-band TYPICAL CHARACTERISTICS

(These are only typical curves and devices are not necessarily guaranteed at these curves.)

$T_a=25\text{deg.C}$, $I_{dQ}=0.1\text{A}$, $P_{in}=0.2\text{W}$

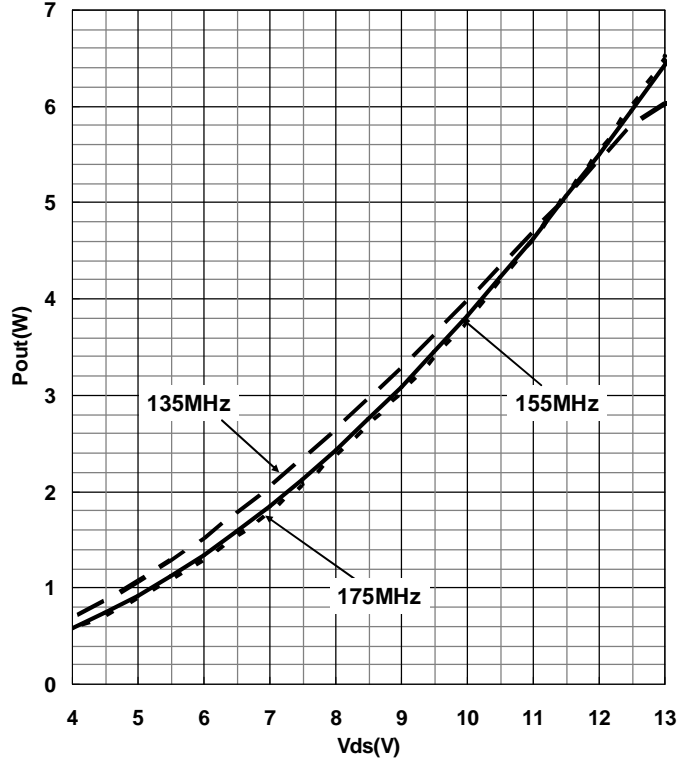

$T_a=25\text{deg.C}$, $I_{dQ}=0.1\text{A}$, $P_{in}=0.2\text{W}$

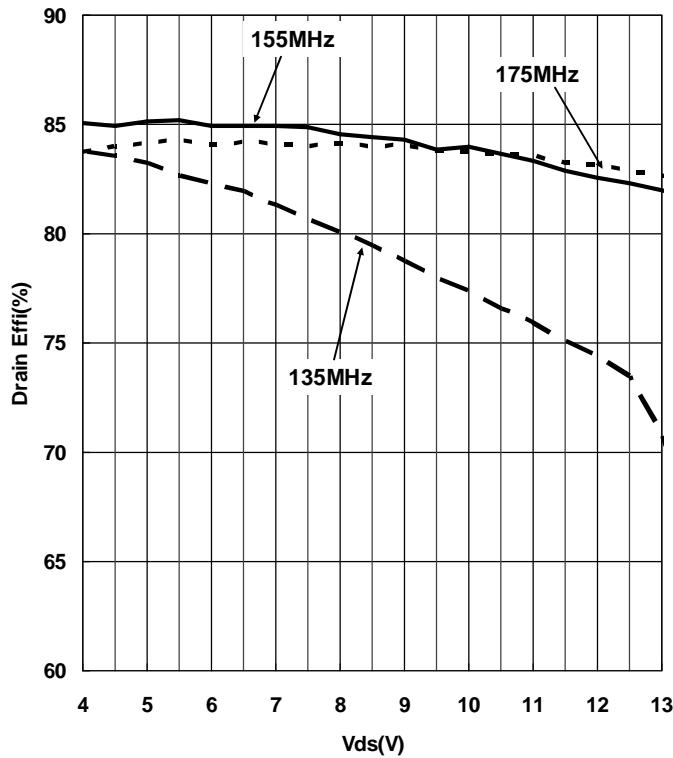

ELECTROSTATIC SENSITIVE DEVICE
OBSERVE HANDLING PRECAUTIONS

RD04HMS2

RoHS Compliance, Silicon MOSFET Power Transistor, 175MHz, 950MHz, 4W

UHF-band TYPICAL CHARACTERISTICS

(These are only typical curves and devices are not necessarily guaranteed at these curves.)

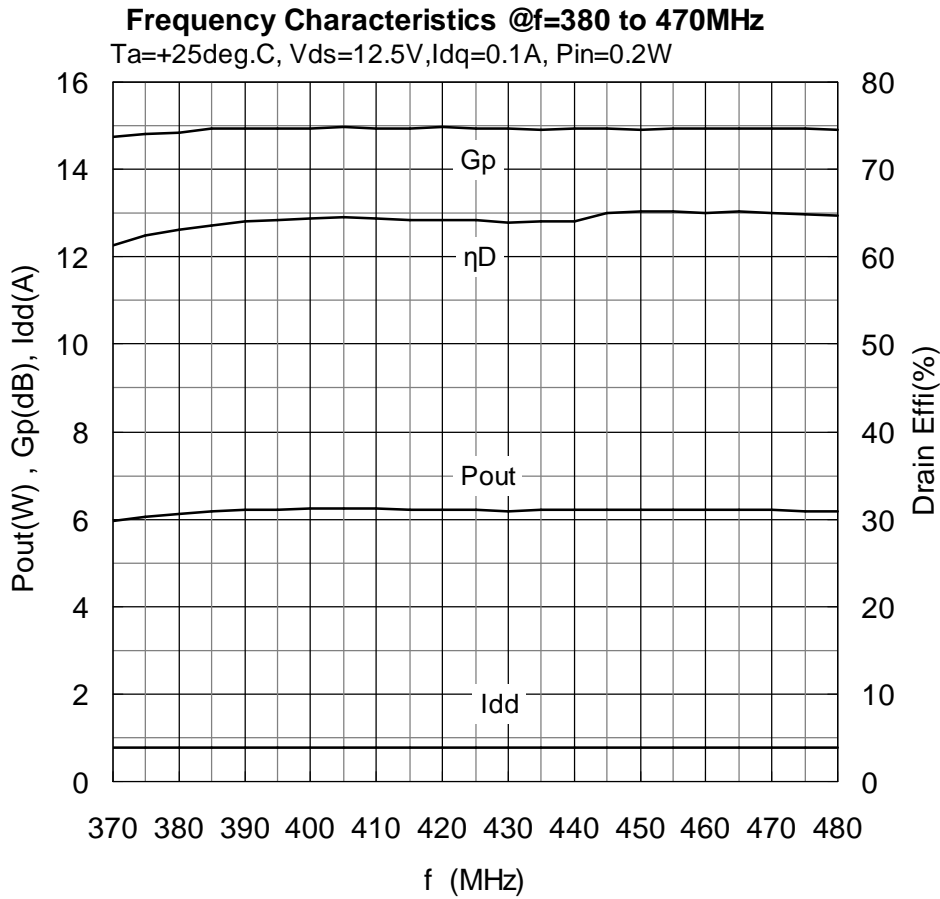

ELECTROSTATIC SENSITIVE DEVICE
OBSERVE HANDLING PRECAUTIONS

RD04HMS2

RoHS Compliance, Silicon MOSFET Power Transistor, 175MHz, 950MHz, 4W

UHF-band TYPICAL CHARACTERISTICS

(These are only typical curves and devices are not necessarily guaranteed at these curves.)

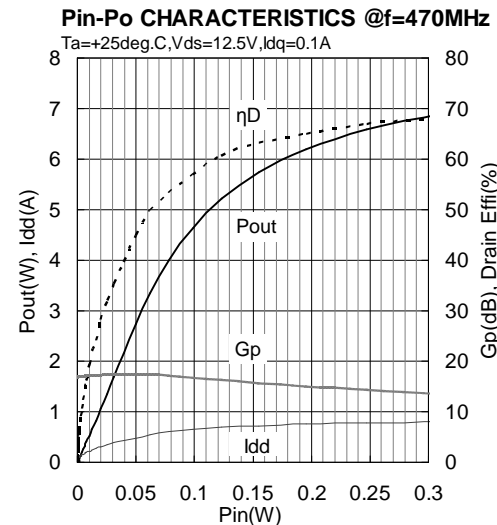
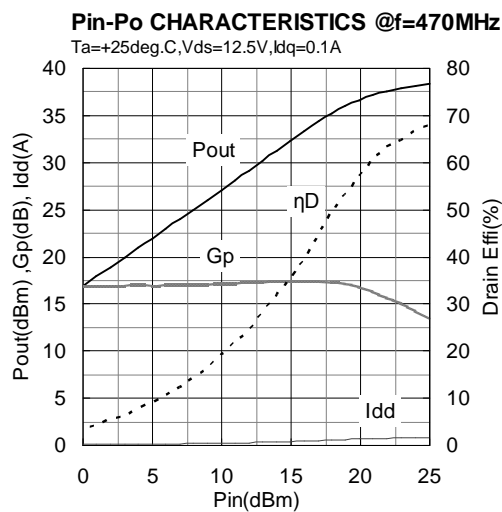
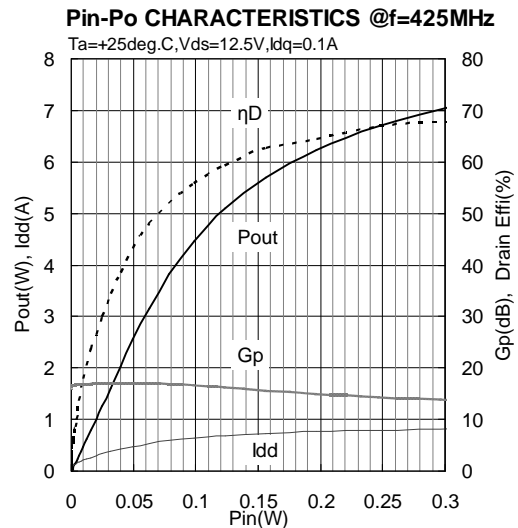
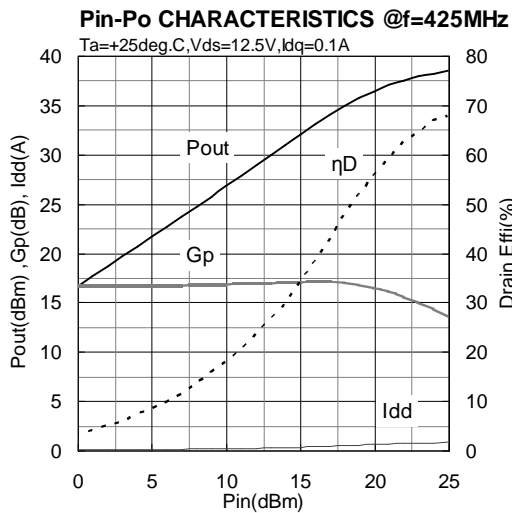
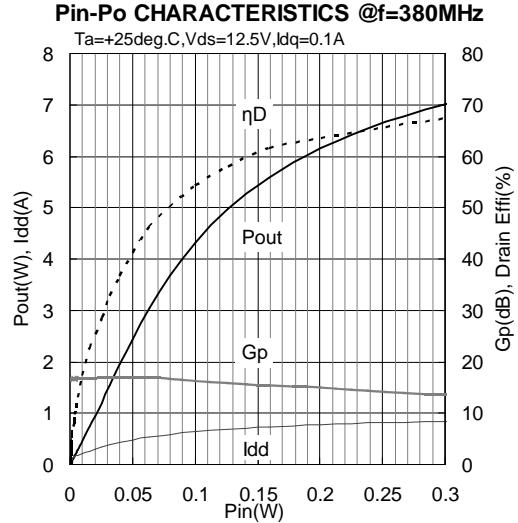
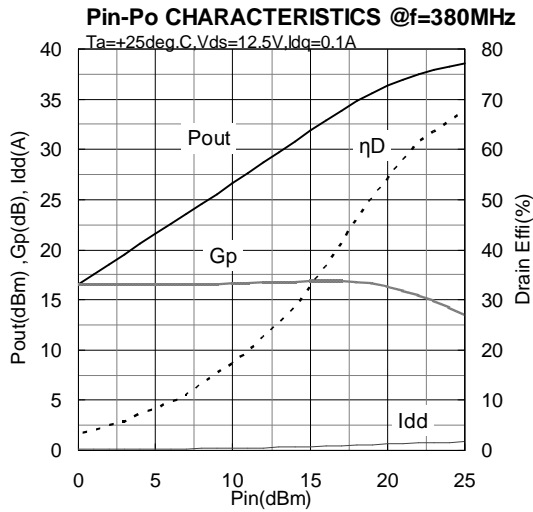

ELECTROSTATIC SENSITIVE DEVICE
OBSERVE HANDLING PRECAUTIONS

RD04HMS2

RoHS Compliance, Silicon MOSFET Power Transistor, 175MHz, 950MHz, 4W

UHF-band TYPICAL CHARACTERISTICS

(These are only typical curves and devices are not necessarily guaranteed at these curves.)

Ta=25deg.C , Idq=0.1A, Pin=0.2W

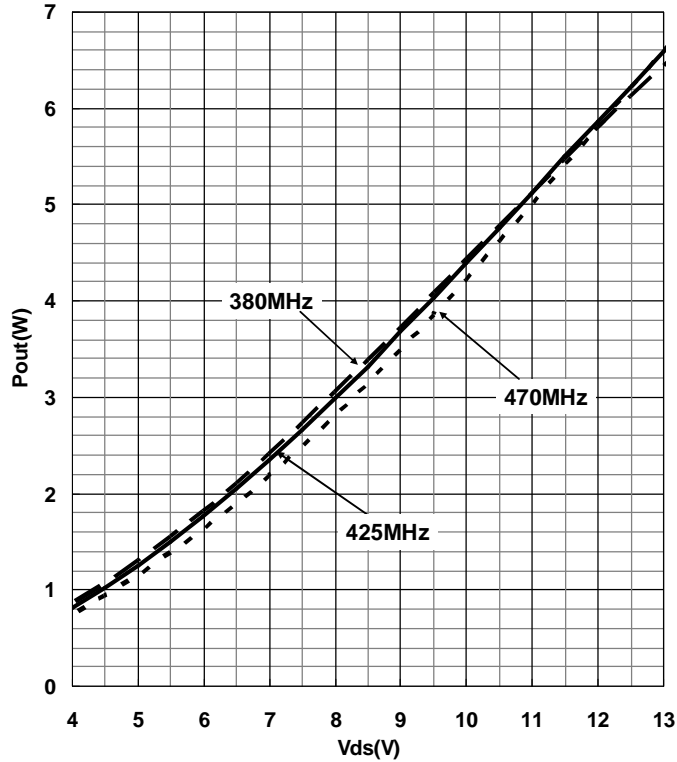

Ta=25deg.C , Idq=0.1A , Pin=0.2W

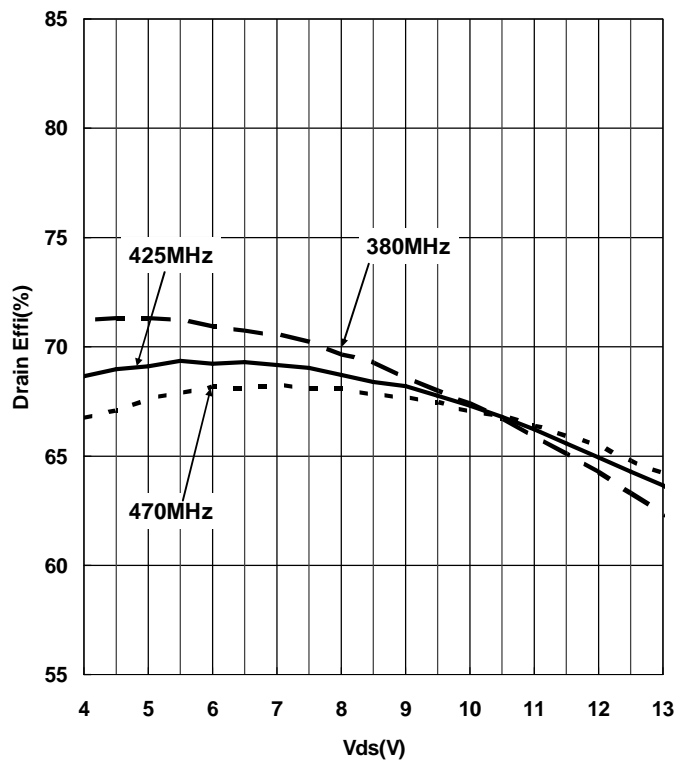

ELECTROSTATIC SENSITIVE DEVICE
OBSERVE HANDLING PRECAUTIONS

RD04HMS2

RoHS Compliance, Silicon MOSFET Power Transistor, 175MHz, 950MHz, 4W

890-950MHz-band TYPICAL CHARACTERISTICS

(These are only typical curves and devices are not necessarily guaranteed at these curves.)

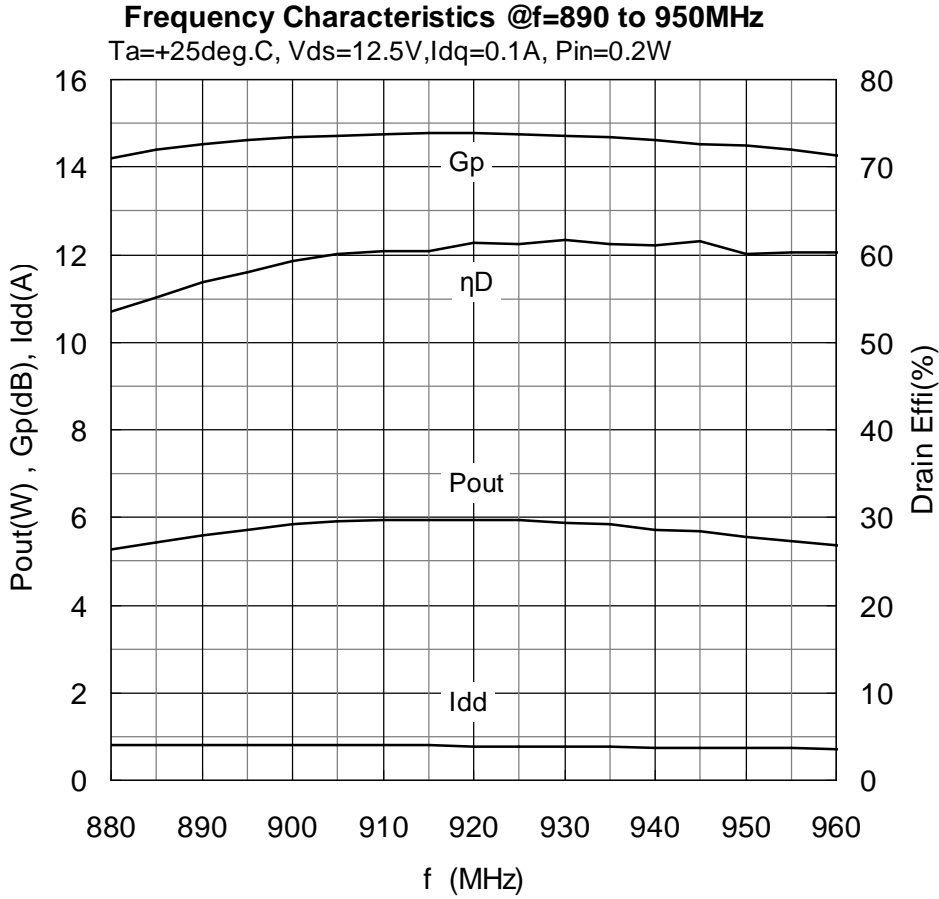

ELECTROSTATIC SENSITIVE DEVICE
OBSERVE HANDLING PRECAUTIONS

RD04HMS2

RoHS Compliance, Silicon MOSFET Power Transistor, 175MHz, 950MHz, 4W

890-950MHz-band TYPICAL CHARACTERISTICS

(These are only typical curves and devices are not necessarily guaranteed at these curves.)

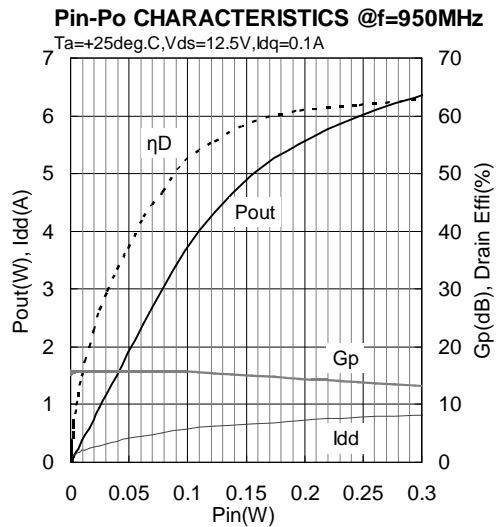
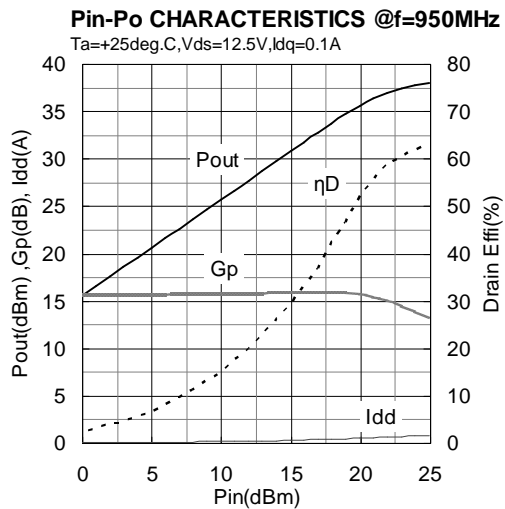
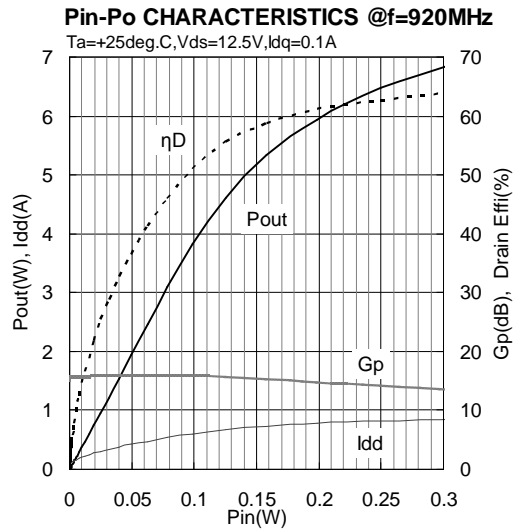
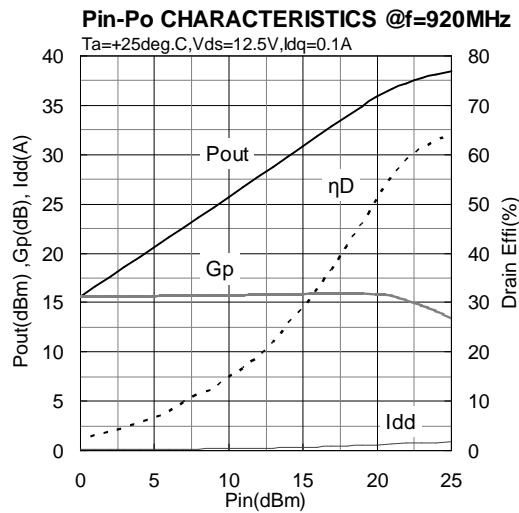
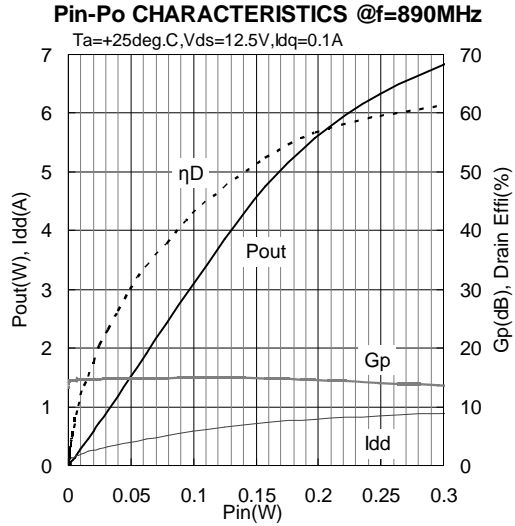
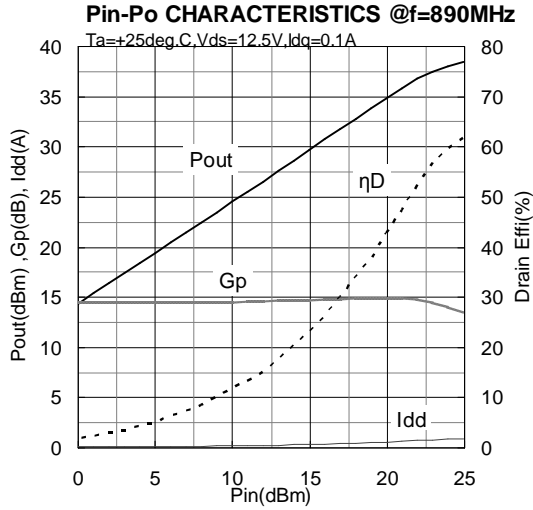

ELECTROSTATIC SENSITIVE DEVICE
OBSERVE HANDLING PRECAUTIONS

RD04HMS2

RoHS Compliance, Silicon MOSFET Power Transistor, 175MHz, 950MHz, 4W

890-950MHz-band TYPICAL CHARACTERISTICS

(These are only typical curves and devices are not necessarily guaranteed at these curves.)

$T_a=25\text{deg.C}$, $I_{dq}=0.1\text{A}$, $P_{in}=0.2\text{W}$

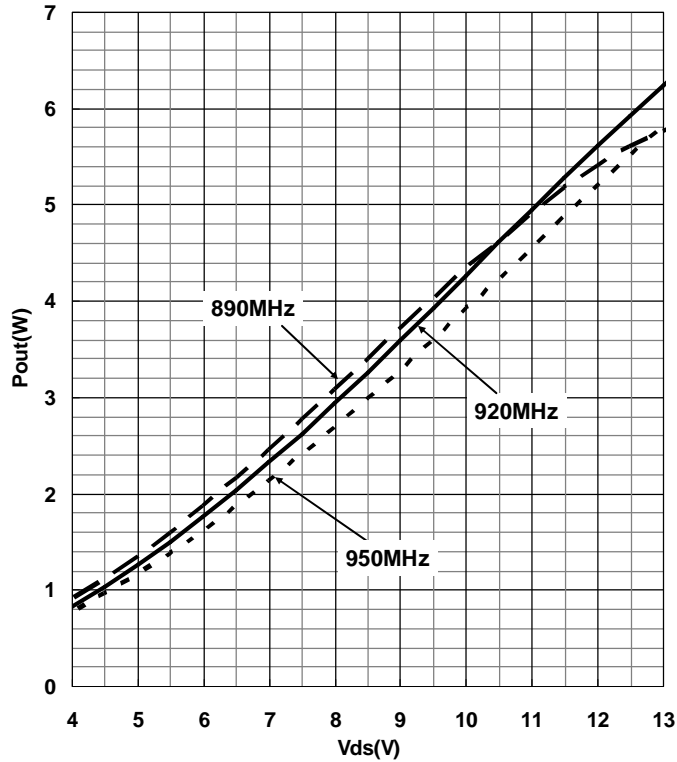

$T_a=25\text{deg.C}$, $I_{dq}=0.1\text{A}$, $P_{in}=0.2\text{W}$

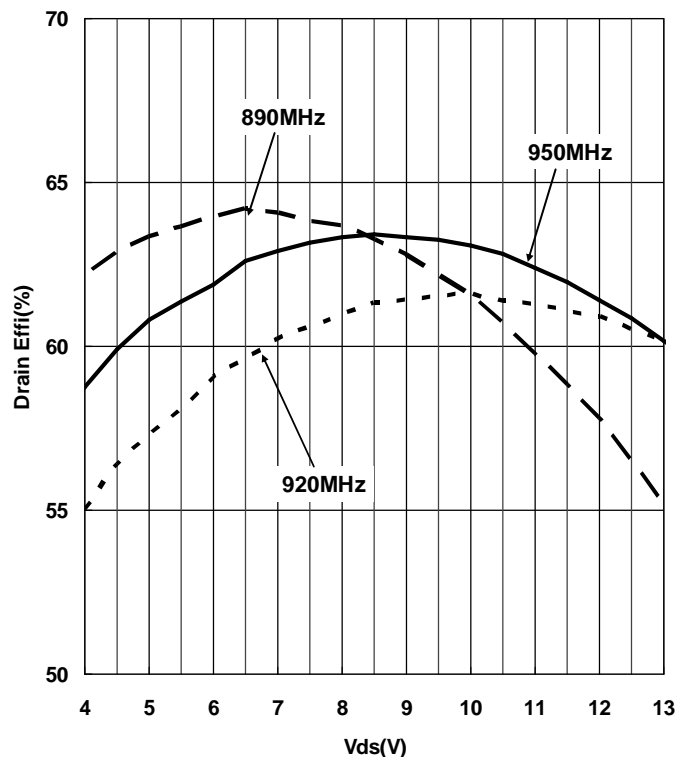

ELECTROSTATIC SENSITIVE DEVICE
OBSERVE HANDLING PRECAUTIONS

RD04HMS2

RoHS Compliance, Silicon MOSFET Power Transistor, 175MHz, 950MHz, 4W

EQUIVALENT CIRCUITRY for VHF EVALUATION BOARD (f=135 – 175MHz)

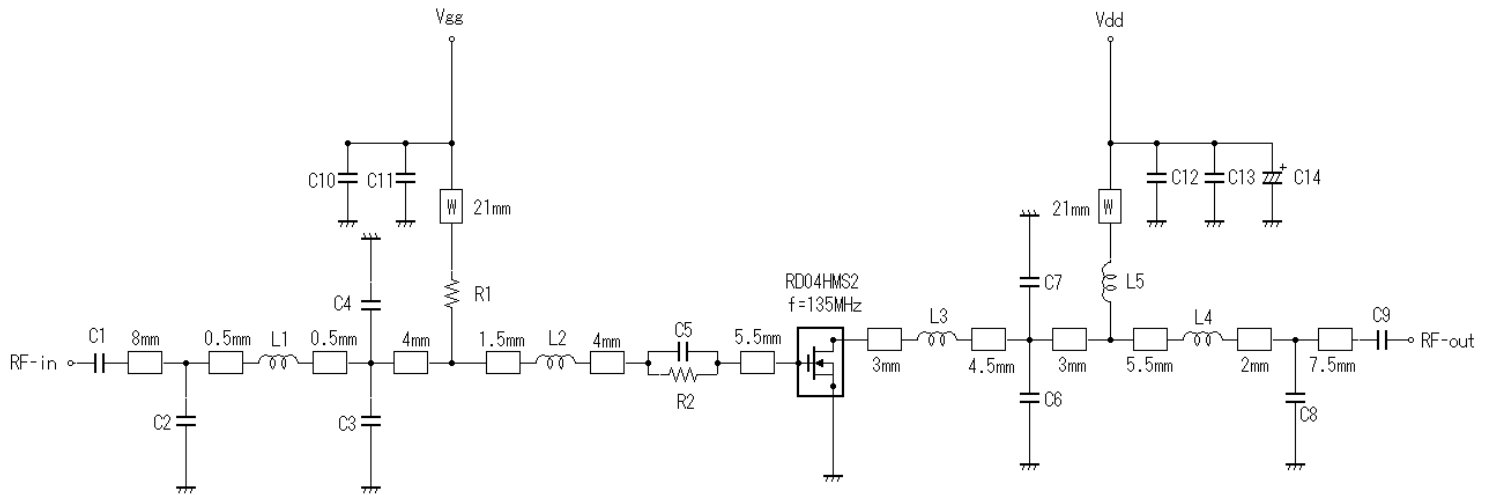

Note: Board material- Glass-Epoxy Substrate
Micro strip line width=1.3mm/500HM, er:4.8, t=0.8mm
W: Line width=1.0mm

C1	100pF	Chip Ceramic Capacitors
C2	27pF	Chip Ceramic Capacitors
C3	30pF	Chip Ceramic Capacitors
C4	30pF	Chip Ceramic Capacitors
C5	36pF	Chip Ceramic Capacitors
C6	39pF	Chip Ceramic Capacitors
C7	39pF	Chip Ceramic Capacitors
C8	24pF	Chip Ceramic Capacitors
C9	100pF	Chip Ceramic Capacitors
C10	1000pF	Chip Ceramic Capacitors
C11	1000pF	Chip Ceramic Capacitors
C12	1000pF	Chip Ceramic Capacitors
C13	1000pF	Chip Ceramic Capacitors
C14	22µF	Electrolytic Capacitor
R1	4.7K OHM	Chip Resistors
R2	47 OHM	Chip Resistors
L1	37nH *	Enameled wire 7Turns, D:0.43mm, 2.46mmO.D
L2	56nH *	Enameled wire 12Turns, D:0.23mm, 1.66mmO.D
L3	22nH *	Enameled wire 5Turns, D:0.43mm, 2.46mmO.D
L4	29nH *	Enameled wire 6Turns, D:0.43mm, 2.46mmO.D
L5	37nH *	Enameled wire 7Turns, D:0.43mm, 2.46mmO.D

* Inductor of Rolling Coil measurement condition : f=100MHz

For more information regarding this evaluation board, refer to APPLICATION NOTE "AN-VHF-051"

ELECTROSTATIC SENSITIVE DEVICE
OBSERVE HANDLING PRECAUTIONS

RD04HMS2

RoHS Compliance, Silicon MOSFET Power Transistor, 175MHz, 950MHz, 4W

EQUIVALENT CIRCUITRY for UHF EVALUATION BOARD (f=380 – 470MHz)

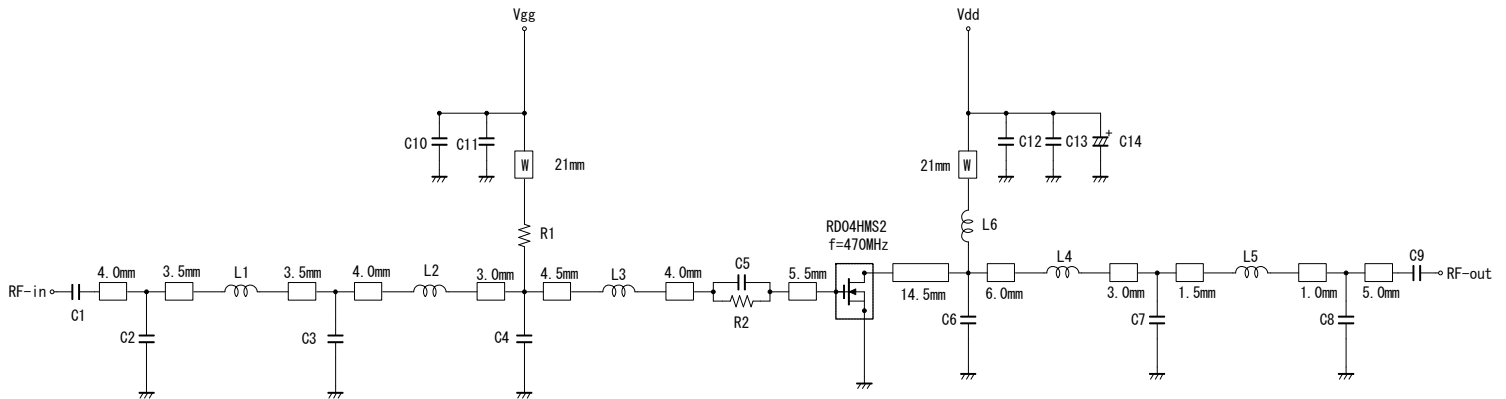

Note: Board material- Glass-Epoxy Substrate
Micro strip line width=1.3mm/50OHM, er:4.8, t=0.8mm
W: Line width=1.0mm

C1	100pF	Chip Ceramic Capacitors
C2	6pF	Chip Ceramic Capacitors
C3	20pF	Chip Ceramic Capacitors
C4	36pF	Chip Ceramic Capacitors
C5	24pF	Chip Ceramic Capacitors
C6	36pF	Chip Ceramic Capacitors
C7	20pF	Chip Ceramic Capacitors
C8	7pF	Chip Ceramic Capacitors
C9	100pF	Chip Ceramic Capacitors
C10	1000pF	Chip Ceramic Capacitors
C11	22000pF	Chip Ceramic Capacitors
C12	1000pF	Chip Ceramic Capacitors
C13	22000pF	Chip Ceramic Capacitors
C14	22μF	Electrolytic Capacitor
R1	4.7K OHM	Chip Resistors
R2	47 OHM	Chip Resistors
L1	12nH *	Enameled wire 3Turns, D:0.23mm, 1.66mmO.D
L2	8nH *	Enameled wire 2Turns, D:0.23mm, 1.66mmO.D
L3	8nH *	Enameled wire 2Turns, D:0.23mm, 1.66mmO.D
L4	8nH *	Enameled wire 2Turns, D:0.23mm, 1.66mmO.D
L5	16nH *	Enameled wire 4Turns, D:0.23mm, 1.66mmO.D
L6	37nH *	Enameled wire 7Turns, D:0.43mm, 2.46mmO.D

* Inductor of Rolling Coil measurement condition : f=100MHz

For more information regarding this evaluation board, refer to APPLICATION NOTE "AN-UHF-114"

ELECTROSTATIC SENSITIVE DEVICE
OBSERVE HANDLING PRECAUTIONS

RD04HMS2

RoHS Compliance, Silicon MOSFET Power Transistor, 175MHz, 950MHz, 4W

EQUIVALENT CIRCUITRY for 890-950MHz EVALUATION BOARD (f=890 – 950MHz)

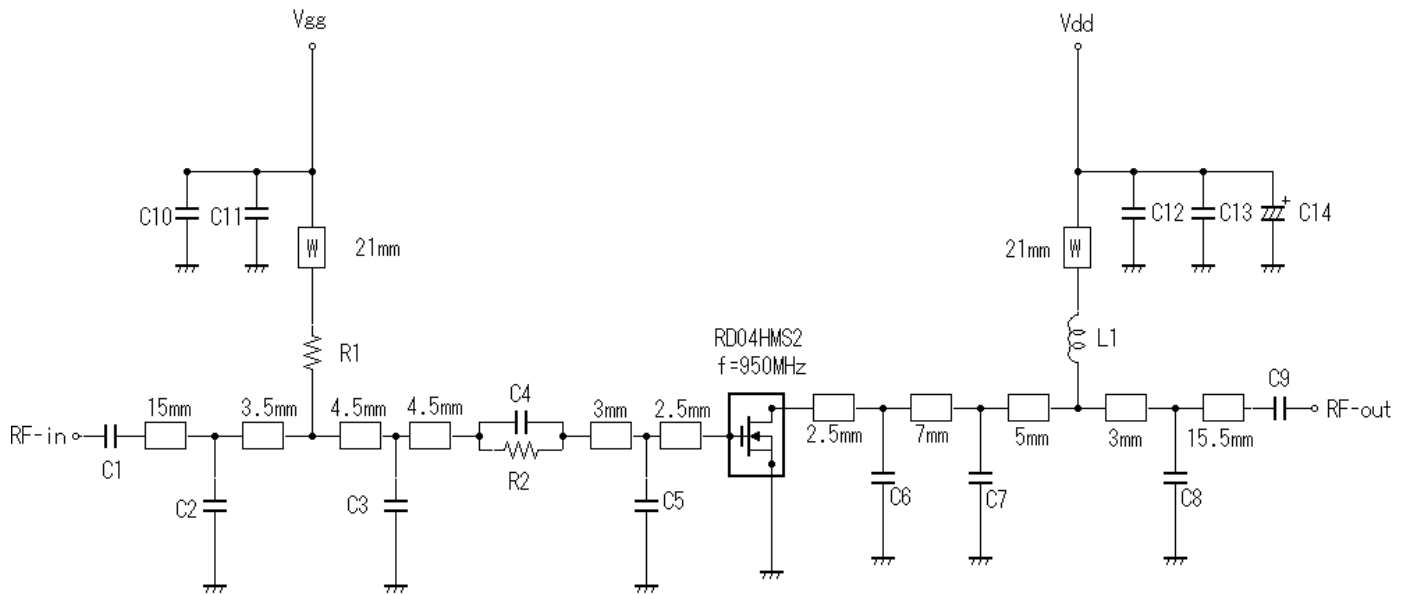

Note: Board material- Glass-Epoxy Substrate
Micro strip line width=1.3mm/500HM, er:4.8, t=0.8mm
W: Line width=1.0mm

C1	150pF	Chip Ceramic Capacitors
C2	4pF	Chip Ceramic Capacitors
C3	9pF	Chip Ceramic Capacitors
C4	16pF	Chip Ceramic Capacitors
C5	10pF	Chip Ceramic Capacitors
C6	12pF	Chip Ceramic Capacitors
C7	5pF	Chip Ceramic Capacitors
C8	4pF	Chip Ceramic Capacitors
C9	150pF	Chip Ceramic Capacitors
C10	100pF	Chip Ceramic Capacitors
C11	1000pF	Chip Ceramic Capacitors
C12	100pF	Chip Ceramic Capacitors
C13	1000pF	Chip Ceramic Capacitors
C14	22μF	Electrolytic Capacitor
R1	4.7K OHM	Chip Resistors
R2	33 OHM	Chip Resistors
L1	37nH *	Enameled wire 7Turns, D:0.43mm, 2.46mmO.D

* Inductor of Rolling Coil measurement condition : f=100MHz

For more information regarding this evaluation board, refer to APPLICATION NOTE "AN-900-043"

ELECTROSTATIC SENSITIVE DEVICE
OBSERVE HANDLING PRECAUTIONS

RD04HMS2

RoHS Compliance, Silicon MOSFET Power Transistor, 175MHz, 950MHz, 4W

Input / Output Impedance VS. Frequency Characteristics

Zin* (f=135, 155, 175MHz)

Zo=50ohm

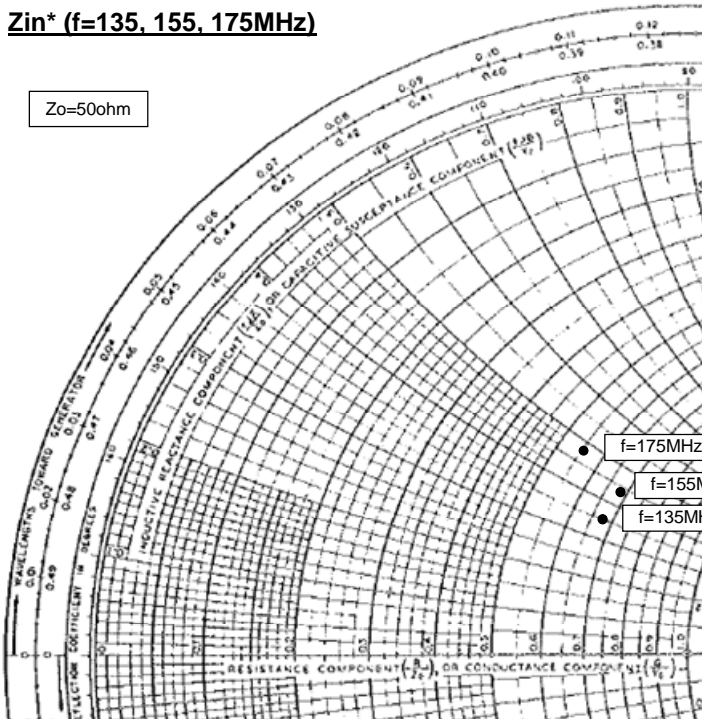

@Pin=0.2W, Vds=12.5V, Idq=0.1A

f (MHz)	Zin* (ohm)
135	34.15 + j 17.78
155	34.90 + j 21.74
175	28.10 + j 24.30

Zin*: Complex conjugate of input impedance

Zout* (f=135, 155, 175MHz)

Zo=50ohm

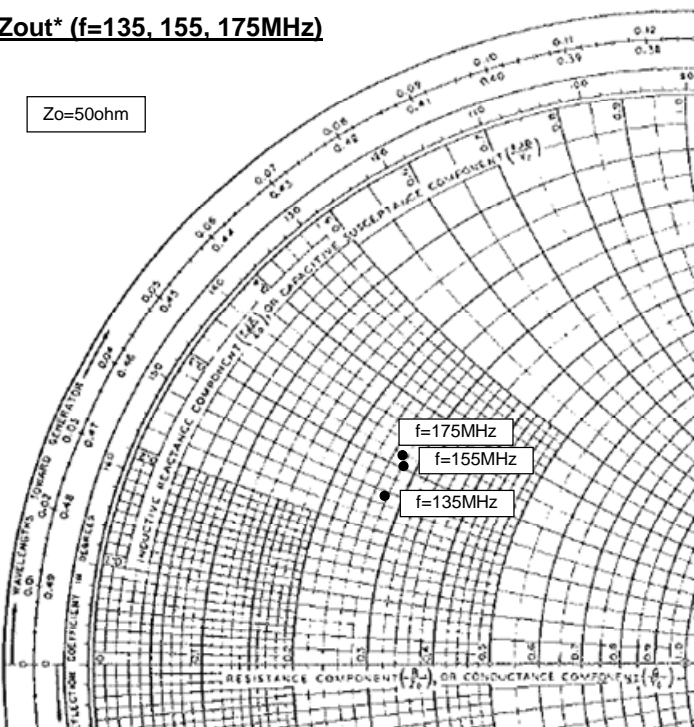

@Pin=0.2W, Vds=12.5V, Idq=0.1A

f (MHz)	Zout* (ohm)
135	14.18 + j 12.41
155	14.45 + j 15.35
175	13.90 + j 15.87

Zout*: Complex conjugate of output impedance

ELECTROSTATIC SENSITIVE DEVICE
OBSERVE HANDLING PRECAUTIONS

RD04HMS2

RoHS Compliance, Silicon MOSFET Power Transistor, 175MHz, 950MHz, 4W

Input / Output Impedance VS. Frequency Characteristics

Zin* (f=380, 425, 470MHz)

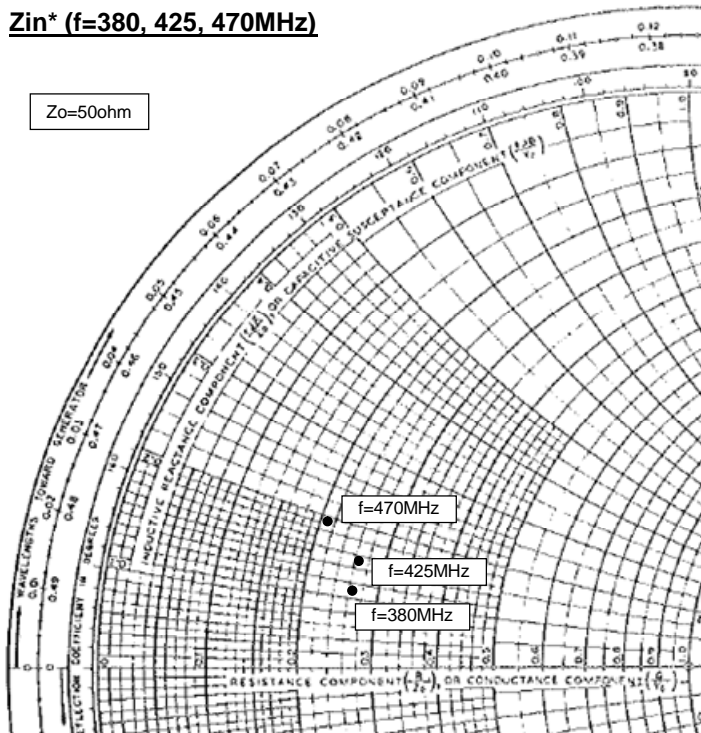

@Pin=0.2W, Vds=12.5V, Idq=0.1A

f (MHz)	Zin* (ohm)
380	13.33 + j 5.61
425	13.49 + j 7.55
470	10.39 + j 9.64

Zin*: Complex conjugate of input impedance

Zout* (f=380, 425, 470MHz)

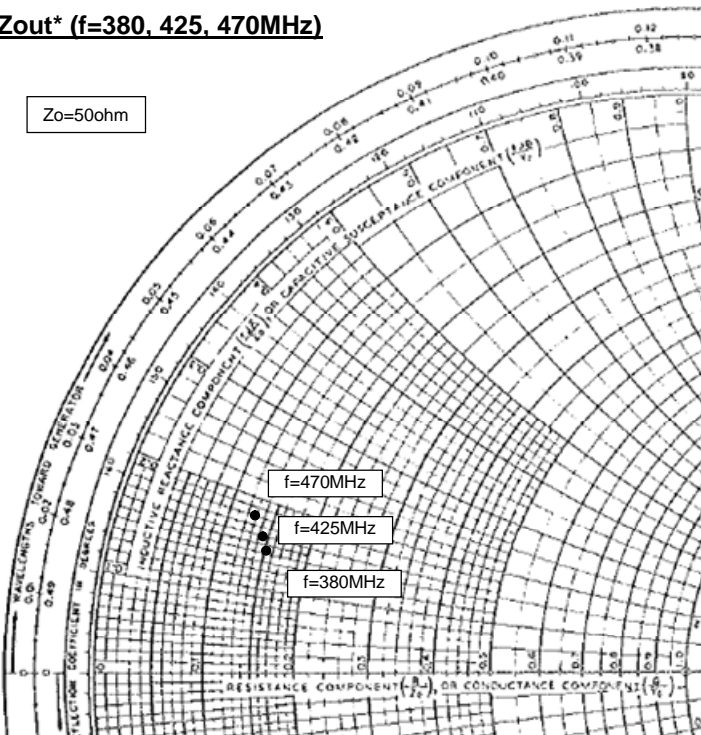

@Pin=0.2W, Vds=12.5V, Idq=0.1A

f (MHz)	Zout* (ohm)
380	7.83 + j 7.20
425	7.35 + j 7.93
470	6.32 + j 8.95

Zout*: Complex conjugate of output impedance

ELECTROSTATIC SENSITIVE DEVICE
OBSERVE HANDLING PRECAUTIONS

RD04HMS2

RoHS Compliance, Silicon MOSFET Power Transistor, 175MHz, 950MHz, 4W

Input / Output Impedance VS. Frequency Characteristics

Zin* (f=890, 920, 950MHz)

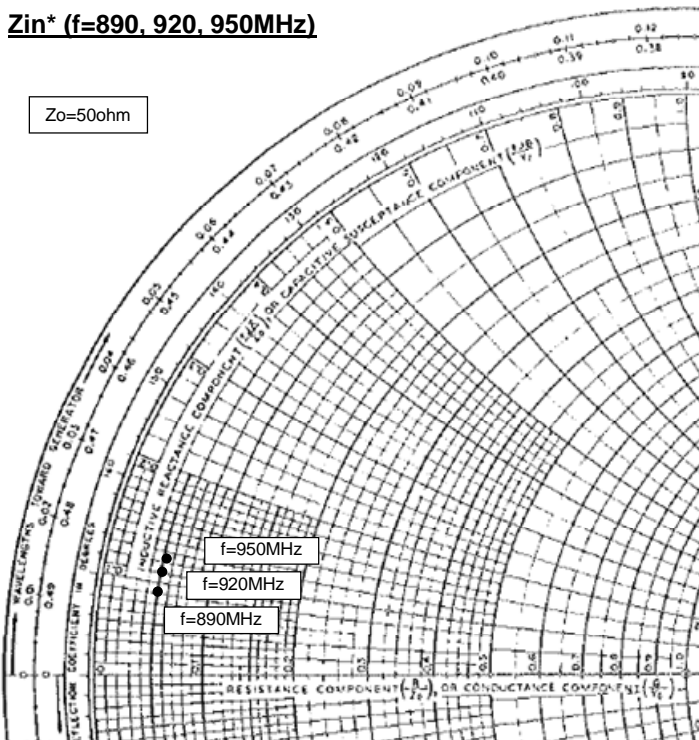

@Pin=0.2W, Vds=12.5V, Idq=0.1A

f (MHz)	Zin* (ohm)
890	2.59 + j 3.87
920	2.60 + j 4.81
950	2.67 + j 5.69

Zin*: Complex conjugate of input impedance

Zout* (f=890, 920, 950MHz)

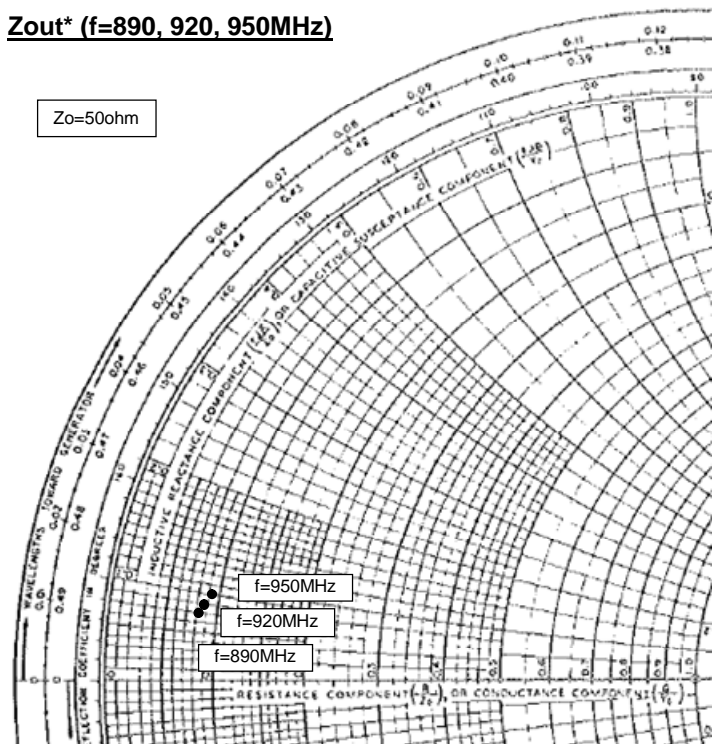

@Pin=0.2W, Vds=12.5V, Idq=0.1A

f (MHz)	Zout* (ohm)
890	4.19 + j 3.38
920	4.47 + j 3.99
950	4.83 + j 4.52

Zout*: Complex conjugate of output impedance

ELECTROSTATIC SENSITIVE DEVICE
OBSERVE HANDLING PRECAUTIONS

RD04HMS2

RoHS Compliance, Silicon MOSFET Power Transistor, 175MHz, 950MHz, 4W

Small Single Parameter of RD04HMS2 (@V_{ds}=12.5V, I_{dq}=100mA)

Freq [MHz]	S11		S21		S12		S22	
	(mag)	(ang)	(mag)	(ang)	(mag)	(ang)	(mag)	(ang)
100	0.813	-120.5	19.034	105.3	0.030	15.3	0.585	-103.6
135	0.800	-132.2	14.641	96.1	0.031	7.2	0.581	-115.2
150	0.799	-136.1	13.199	92.8	0.031	4.0	0.585	-118.9
175	0.799	-141.1	11.253	88.0	0.030	-0.4	0.595	-124.0
200	0.803	-145.1	9.749	83.8	0.030	-4.2	0.610	-128.0
250	0.817	-151.2	7.504	77.0	0.028	-10.0	0.644	-134.0
300	0.829	-155.4	6.002	71.2	0.027	-15.6	0.679	-138.6
350	0.843	-158.7	4.890	66.6	0.025	-19.4	0.713	-142.4
380	0.851	-160.3	4.339	64.5	0.024	-21.5	0.732	-144.6
400	0.856	-161.4	4.069	63.2	0.023	-22.8	0.744	-146.0
450	0.868	-163.7	3.394	59.4	0.022	-25.5	0.773	-148.9
470	0.876	-164.7	3.196	58.5	0.021	-26.6	0.783	-150.0
500	0.884	-166.0	2.894	56.1	0.020	-27.1	0.797	-151.6
550	0.893	-167.7	2.506	54.6	0.018	-28.6	0.818	-154.0
600	0.901	-169.3	2.150	52.7	0.017	-30.0	0.836	-156.3
650	0.907	-170.7	1.840	49.8	0.016	-31.5	0.852	-158.3
700	0.917	-172.2	1.636	49.2	0.014	-30.4	0.866	-160.1
750	0.923	-173.4	1.454	48.5	0.013	-31.2	0.877	-161.8
800	0.928	-174.4	1.263	48.0	0.012	-30.7	0.888	-163.3
850	0.931	-175.4	1.119	46.5	0.011	-29.9	0.899	-164.7
890	0.933	-176.0	1.049	48.2	0.010	-30.5	0.906	-165.7
900	0.934	-176.1	1.035	47.6	0.010	-30.6	0.908	-166.0
950	0.936	-176.8	0.914	46.7	0.008	-29.0	0.913	-167.1
1000	0.939	-177.4	0.838	46.8	0.008	-28.0	0.919	-168.1
1050	0.941	-178.0	0.758	46.8	0.007	-25.7	0.924	-169.0
1100	0.942	-178.4	0.702	48.8	0.006	-23.6	0.928	-170.0

ATTENTION:

1. High Temperature ; This product might have a heat generation while operation, Please take notice that have a possibility to receive a burn to touch the operating product directly or touch the product until cold after switch off. At the near the product, do not place the combustible material that have possibilities to arise the fire.
2. Generation of High Frequency Power ; This product generate a high frequency power. Please take notice that do not leakage the unnecessary electric wave and use this products without cause damage for human and property per normal operation.
3. Before use; Before use the product, Please design the equipment in consideration of the risk for human and electric wave obstacle for equipment.

PRECAUTIONS FOR THE USE OF MITSUBISHI SILICON RF POWER DEVICES:

1. The specifications of mention are not guarantee values in this data sheet. Please confirm additional details regarding operation of these products from the formal specification sheet. For copies of the formal specification sheets, please contact one of our sales offices.
2. RD series products (RF power transistors) are designed for consumer mobile communication terminals and were not specifically designed for use in other applications. In particular, while these products are highly reliable for their designed purpose, they are not manufactured under a quality assurance testing protocol that is sufficient to guarantee the level of reliability typically deemed necessary for critical communications elements. Examples of critical communications elements would include transmitters for base station applications and fixed station applications that operate with long term continuous transmission and a higher on-off frequency during transmitting, especially for systems that may have a high impact to society.
3. RD series products use MOSFET semiconductor technology. They are sensitive to ESD voltage therefore appropriate ESD precautions are required.
4. In the case of use in below than recommended frequency, there is possibility to occur that the device is deteriorated or destroyed due to the RF-swing exceed the breakdown voltage.
5. In order to maximize reliability of the equipment, it is better to keep the devices temperature low. It is recommended to utilize a sufficient sized heat-sink in conjunction with other cooling methods as needed (fan, etc.) to keep the channel temperature for RD series products lower than 120deg/C (in case of $T_{chmax}=150deg/C$), 140deg/C (in case of $T_{chmax}=175deg/C$) under standard conditions.
6. Do not use the device at the exceeded the maximum rating condition. In case of plastic molded devices, the exceeded maximum rating condition may cause blowout, smoldering or catch fire of the molding resin due to extreme short current flow between the drain and the source of the device. These results causes in fire or injury.
7. For specific precautions regarding assembly of these products into the equipment, please refer to the supplementary items in the specification sheet.
8. Warranty for the product is void if the products protective cap (lid) is removed or if the product is modified in any way from it's original form.
9. For additional "Safety first" in your circuit design and notes regarding the materials, please refer the last page of this data sheet.
10. Please refer to the additional precautions in the formal specification sheet.

ELECTROSTATIC SENSITIVE DEVICE
OBSERVE HANDLING PRECAUTIONS

RD04HMS2

RoHS Compliance, Silicon MOSFET Power Transistor, 175MHz, 950MHz, 4W

Keep safety first in your circuit designs !

Mitsubishi Electric Corporation puts the maximum effort into making semiconductor products better and more reliable, but there is always the possibility that trouble may occur with them. Trouble with semiconductors may lead to personal injury, fire or property damage. Remember to give due consideration to safety when making your circuit designs, with appropriate measures such as (i) placement of substitutive, auxiliary circuits, (ii) use of non-flammable material or (iii) prevention against any malfunction or mishap.

Notes regarding these materials

- These materials are intended as a reference to assist our customers in the selection of the Mitsubishi semiconductor product best suited to the customer's application; they do not convey any license under any intellectual property rights, or any other rights, belonging to Mitsubishi Electric Corporation or a third party.
- Mitsubishi Electric Corporation assumes no responsibility for any damage, or infringement of any third-party's rights, originating in the use of any product data, diagrams, charts, programs, algorithms, or circuit application examples contained in these materials.
- All information contained in these materials, including product data, diagrams, charts, programs and algorithms represents information on products at the time of publication of these materials, and are subject to change by Mitsubishi Electric Corporation without notice due to product improvements or other reasons. It is therefore recommended that customers contact Mitsubishi Electric Corporation or an authorized Mitsubishi Semiconductor product distributor for the latest product information before purchasing a product listed herein. The information described here may contain technical inaccuracies or typographical errors. Mitsubishi Electric Corporation assumes no responsibility for any damage, liability, or other loss rising from these inaccuracies or errors. Please also pay attention to information published by Mitsubishi Electric Corporation by various means, including the Mitsubishi Semiconductor home page (<http://www.mitsubishichips.com>).
- When using any or all of the information contained in these materials, including product data, diagrams, charts, programs, and algorithms, please be sure to evaluate all information as a total system before making a final decision on the applicability of the information and products. Mitsubishi Electric Corporation assumes no responsibility for any damage, liability or other loss resulting from the information contained herein.
- Mitsubishi Electric Corporation semiconductors are not designed or manufactured for use in a device or system that is used under circumstances in which human life is potentially at stake. Please contact Mitsubishi Electric Corporation or an authorized Mitsubishi Semiconductor product distributor when considering the use of a product contained herein for any specific purposes, such as apparatus or systems for transportation, vehicular, medical, aerospace, nuclear, or undersea repeater use.
- The prior written approval of Mitsubishi Electric Corporation is necessary to reprint or reproduce in whole or in part these materials.
- If these products or technologies are subject to the Japanese export control restrictions, they must be exported under a license from the Japanese government and cannot be imported into a country other than the approved destination.
Any diversion or reexport contrary to the export control laws and regulations of Japan and/or the country of destination is prohibited.
- Please contact Mitsubishi Electric Corporation or an authorized Mitsubishi Semiconductor product distributor for further details on these materials or the products contained therein.