



LA8580W

Compander + I/O Switching Telephone Audio Signal-Processing IC

Overview

The LA8580W is an I/O switching audio signal-processing IC for low-power cordless telephone base sets. It also supports personal fax machines for the Japanese domestic market. It integrates an extensive set of functions, including a compander, a crosspoint switch for I/O switching, an electronic volume control, and level switching, ALC, VOX, and filter circuits.

Applications

Low-power cordless telephone base sets and Japanese market home fax machines.

Functions

- Crosspoint switch (equivalent to 10×9) and electronic volume control (VOL)
- Audio level switching (ATT) for the telephone circuit system, the handset system, both DSP systems, the doorphone system, and the microphone system
- Dedicated ring-tone input pin (OSC-IN), ring-tone level switching (OSC-ATT), ring-tone muting (OSC-SW)
- ALC amplifier, audio level detection (VOX), operational amplifiers for the DSP I/O filters.
- Compressor, limiter (IDC), compressor system muting, splatter filter.
- Expander, receive system input filter amplifier, and expander system muting
- Receive system data waveform shaping (with threshold follower on/off function)
- Serial interface (8-bit serial data input)

Features

- Includes a 10 input system/9 output system crosspoint switch that supports mixing. Systems that provide flexible and complex switching of signal paths can be implemented easily.

- Built-in electronic volume control (about 2 dB per step over 15 steps) and extensive set of level switching circuits allow this IC to easily switch signals with a wide range of levels.
- A compander circuit, which provides noise reduction during communication, is built in. This circuit can also be used for noise suppression and improved audio quality in wireless communication systems.
- Built-in splatter filter (fifth order Butterworth filter with settable center frequency) for reduced parts counts.

Package Dimensions

unit: mm

3190A-SQFP64 (0.5 mm lead pitch)

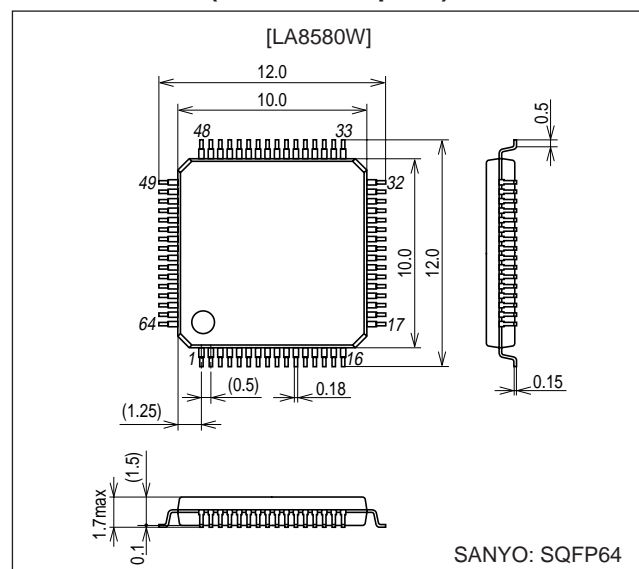

■ Any and all SANYO products described or contained herein do not have specifications that can handle applications that require extremely high levels of reliability, such as life-support systems, aircraft's control systems, or other applications whose failure can be reasonably expected to result in serious physical and/or material damage. Consult with your SANYO representative nearest you before using any SANYO products described or contained herein in such applications.

■ SANYO assumes no responsibility for equipment failures that result from using products at values that exceed, even momentarily, rated values (such as maximum ratings, operating condition ranges, or other parameters) listed in products specifications of any and all SANYO products described or contained herein.

SANYO Electric Co.,Ltd. Semiconductor Company

TOKYO OFFICE Tokyo Bldg., 1-10, 1 Chome, Ueno, Taito-ku, TOKYO, 110-8534 JAPAN

LA8580W

Specifications

Maximum Ratings at $T_a = 25^\circ\text{C}$

Parameter	Symbol	Conditions	Ratings	Unit
Maximum supply voltage	V_{CC} max		7.0	V
Allowable power dissipation	P_{dmax}	$T_a \leq 70^\circ\text{C}$	150	mW
Operating temperature	T_{opr}		-20 to +70	$^\circ\text{C}$
Storage temperature	T_{stg}		-40 to +150	$^\circ\text{C}$

Operating Conditions at $T_a = 25^\circ\text{C}$

Parameter	Symbol	Conditions	Ratings	Unit
Recommended supply voltage	V_{CC}		5	V
Allowable operating supply voltage range	V_{CCop}		4.5 to 5.5	V

Electrical Characteristics at $T_a = 25^\circ\text{C}$, $V_{CC} = 5\text{ V}$, $f_{in} = 1\text{ kHz}$

Parameter	Symbol	Conditions	Ratings			Unit
			min	typ	max	
Quiescent current	ICCO	No signal (Default mode)	7.5	14.5	21	mA
[CMP Block] $V_{inrefc} = -40\text{ dBV} = 0\text{ dB}$, CMP-PRE Amp Gain = 20 dB, $R_L = 10\text{ k}\Omega$						
Output level	VCMP	$V_{in} = V_{inrefc} = 0\text{ dB}$	-15.4	-13.4	-11.4	dBV
Gain error	GEC	$V_{in} = -40\text{ dB}$	-2.5	-0.4	+1	dB
Total harmonic distortion	THDC	$V_{in} = 0\text{ dBV}$	—	0.4	1	%
Output noise voltage	NCMP	$R_g = 620\ \Omega$, $f = 20\text{ to }20\text{ kHz}$	—	1.5	4	mVrms
Preamplifier maximum voltage gain	GMXC		30	—	—	dB
Limiting voltage	VLT		0.83	1.04	1.3	Vp-p
TX data output level	VTXD	$V_{in} = -10\text{ dBV}$ (Input: pin 8)	-15	-13.5	-12	dBV
Maximum output level	VMXC	THD = 1.5%	-5.5	-1.6	—	dBV
LPF attenuation	LPF	$f_{in} = 5\text{ kHz}$, Fifth-order Butterworth filter ($f_c = 3.45\text{ kHz}$)	9.5	13.5	20	dB
Muting attenuation	MTC	$V_{in} = +30\text{ dB}$, 1 kHz-BPF	—	-78	-65	dBV
Crosstalk	CTC	EXP- $V_{in} = -20\text{ dBV}$, 1 kHz-BPF	—	-57	-50	dBV
[EXP Block] $V_{inrefe} = -20\text{ dBV} = 0\text{ dB}$, $R_L = 10\text{ k}\Omega$						
Output level	CEXP	$V_{in} = V_{inrefe} = 0\text{ dB}$	-20.3	-17.8	-15.3	dBV
Gain error	GEE	$V_{in} = -30\text{ dB}$	-1.5	+0.3	+2	dB
Total harmonic distortion	THDE	$V_{in} = 0\text{ dBV}$	—	0.3	1	%
Output noise voltage	NEXP	$R_g = 620\ \Omega$, $f = 20\text{ to }20\text{ kHz}$	—	17	50	μVrms
Maximum output level 1	VMXE1	THD = 1.5%	-6	-2	—	dBV
Maximum output level 2	VMXE2	THD = 1.5%, $R_L \geq 15\text{ k}\Omega$	-4	0	—	dBV
Muting attenuation	MTE	$V_{in} = +10\text{ dB}$, 1 kHz BPF	—	-100	-82	dBV
Crosstalk	CTE	CMP- $V_{in} = -10\text{ dBV}$, 1 kHz BPF	—	-96	-75	dBV
[Data Shaper] $V_{in} = -20\text{ dBV}$, $R_L = 47\text{ k}\Omega$						
Duty	DUTY		43	50	57	%
Input sensitivity	SDT		-39	-34.5	-30	dBV
Output high level voltage	VHDT		4.7	4.97	—	V
Output low level voltage	VLDT		—	0.15	0.4	V
[Crosspoint Switch] $R_L = 10\text{ k}\Omega$						
Voltage gain	GCSW	$V_{in} = -10\text{ dBV}$	-1.5	+0.5	+2.5	dB
Maximum input level	VIMXS	THD = 1.5%	-5	-1.5	—	dBV
Maximum output level 1	VMXS1	THD = 1.5%	-10	-6	—	dBV
Maximum output level 2	VMXS2	THD = 1.5%, $R_L \geq 18\text{ k}\Omega$	-5	-1.5	—	dBV
Output noise voltage	NCSW	$R_g = 620\ \Omega$, $f = 20\text{ to }20\text{ kHz}$	—	10	40	μVrms
Crosstalk	CTCSW	$V_{in} = -10\text{ dBV}$, 1 kHz BPF	—	-100	-80	dBV

Continued on next page.

LA8580W

Continued from preceding page.

Parameter	Symbol	Conditions	Ratings			Unit
			min	typ	max	
[ALC Amplifier: Input from the crosspoint switch] RL = 10 kΩ						
ALC saturation output level	VALC	Vin = -10 dBV	90	110	135	mVrms
Total harmonic distortion	THDA	Vin = -20 dBV	—	0.35	1	%
ALC range	WALC	From the point ALC turns on until the THD reaches 1%	20	26	—	dB
Output noise voltage	NCSW	Rg = 620 Ω, f = 20 to 20 kHz	—	70	200	μVrms
Voltage gain	GALC	Vin = -40 dBV (ALC-OFF mode)	9.8	11.8	13.8	dB
Preamplifier maximum voltage gain	GMXA		30	—	—	dB
[Microphone Amplifier]						
Voltage gain	GMIC	Vin = -40 dBV	29.6	30.6	31.6	dB
Total harmonic distortion	THDM	Vin = -40 dBV	—	0.1	1	%
Output noise voltage	NMIC	Rg = 620 Ω, f = 20 to 20 kHz	—	70	200	μVrms
Maximum voltage gain	GMXM		40	—	—	dB
[Audio Level Detector: VOX] VOX-input Amp Gain = 20 dB, RL = 47 kΩ						
Input sensitivity	SVOX		-45.6	-43.6	-41.6	dBV
Input amplifier maximum voltage gain	GMXV		30	—	—	dB
Output high level voltage	VHVX	VOX-OFF mode (Small input signal)	4.7	4.97	—	V
Output low level voltage	VLVX	VOX-ON mode (Large input signal)	—	0.15	0.4	V
[Electronic Volume Control and Level Switching Step Widths]						
VOL step width	STVOL	(15 steps)	1.5	2	2.5	dB
CDC1-ATT step width	STCD1	(3 steps)	2.5	3.1	3.7	dB
CDC2-ATT step width	STCD2	(3 steps)	2.5	3.1	3.7	dB
DOOR-ATT step width	STDR	(3 steps)	2.5	3.1	3.7	dB
HAND-ATT step width	STHD	(3 steps)	5	6	7	dB
LINE-ATT step width	STLN	(3 steps)	3.3	4.1	4.9	dB
OSC-ATT step width	STOS	(3 steps)	4.1	5.1	6.1	dB
MIC-ATT step width	STMC	(1 step)	5.1	6.1	7.1	dB
[Serial Data Input System] Pins 62, 63, 64						
Clock frequency	FCK		—	—	1	MHz
Input high level voltage	VHSD		1.8	—	—	V
Input low level voltage	VLSD		—	—	0.4	V
[Reset Control Input] Pin 61						
Reset control voltage	VRST		—	—	0.4	V
Reset clear sink current	IST		40	—	—	μA
[Muting Control Input] Pins 2,3						
Input high level voltage	VHSD		1.8	—	—	V
Input low level voltage	VLSD		—	—	0.4	V
[Control Output Pins: PA-CNR, TR-CNT] Pins 4, 5						
Source current	ISRC	Default mode (Addresses 4B and 7F: bit D = 0)	20	—	—	μA
Sink current	ISNK	(Addresses 4B and 7F: bit D = 1)	—	—	100	μA

Block Diagram

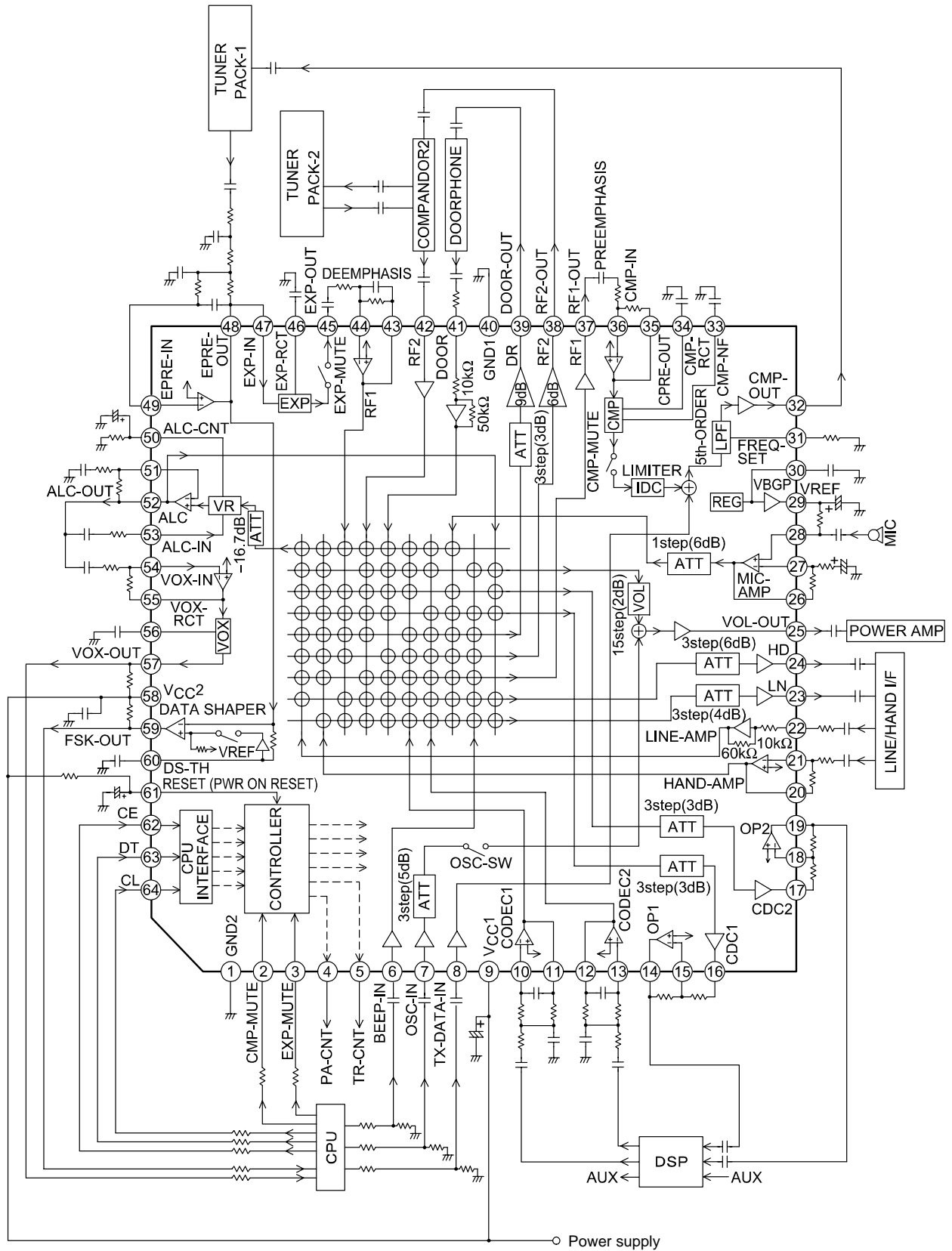

Serial Data Format (8 bits)

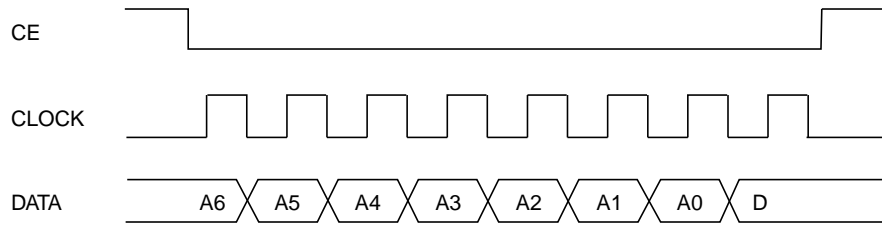

A6 to A0: Set the address of the crosspoint switch, control switch, or other item to be controlled. (hexadecimal number => binary number)

D: Controls the on/off state of the crosspoint switch, control switch, or other item. (After a reset, D values are cleared to 0)

- (1) When a state is set by the D value (Normally D = 0: Switch off, D = 1: Switch on)
 Crosspoint switch control, ALC control, TR-CNT (pin 5) control, OSC-SW control, MIC-ATT control, PA-CNT (pin 4) control
- (2) When no states are changed by the D value (D can be either 0 or 1)
 Reset (default) control, electronic volume control (VOL) control, DR-ATT control, CDC1-ATT control, CDC2-ATT control, OSC-ATT control, LN-ATT control, HD-ATT control.

Serial Data Timing

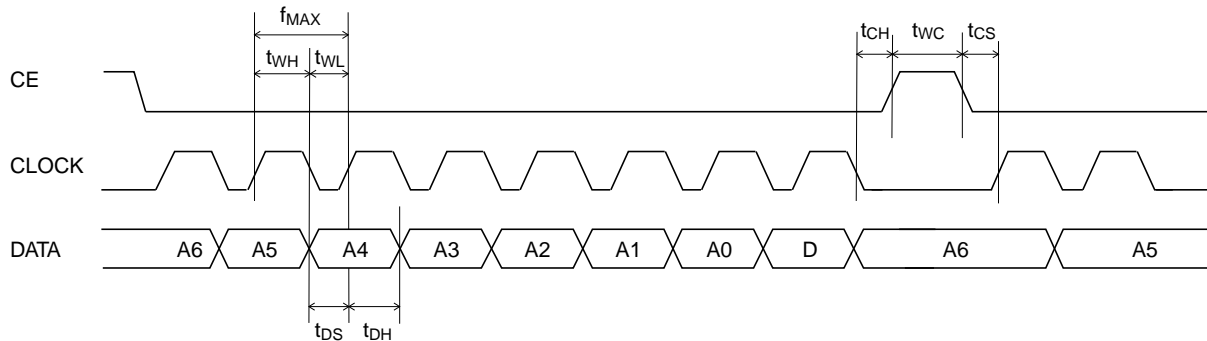

- f_{MAX} (maximum clock frequency): 1 MHz
- t_{WL} (low-level clock pulse width): At least 0.5 μ s
- t_{WH} (high-level clock pulse width): At least 0.5 μ s
- t_{DS} (data setup time): At least 0.5 μ s
- t_{DH} (data hold time): At least 0.5 μ s
- t_{CS} (chip enable setup time): At least 1 μ s
- t_{CH} (chip enable hold time): At least 1 μ s
- t_{WC} (chip enable pulse width): At least 1 μ s

*: When data is not being input, CE must be held high and CLOCK must be held low.

Note: Notes on control data input after power is first applied

- The following control data must be issued at least 200 ms after power is first applied.
 - (1) ALC-OFF (address 4A, D = 1)
 - *: When the supply voltage rises, ALP preamplifier impulse noise will charge the capacitor connected to pin 50, and the ALC circuit will operate in the no signal state. Thus the charge on this capacitor must be discharged.
 - (2) Reset (Address 00: D = 0)
 - Note that if the ALC function is not used, the reset may be applied first.

LA8580W

LA8580W Crosspoint Switch Address Table (hexadecimal values)

Input \ Output	LINE (Pin 23)	HAND (Pin 24)	RF1 (Pin 37)	RF2 (Pin 38)	DOOR (Pin 39)	CDC1 (Pin 16)	CDC2 (Pin 17)	VOL (Pin 25)	ALC (Pin 52)
LINE (Pin 22)		0A	13	1A	22	2A	32	3A	42
HAND (Pin 20)	01		14	1B	23	2B	33	3B	43
RF1 (Pin 43)	02	0B		1C	24	2C	34		44
RF2 (Pin 42)	03	0C	15		25	2D	35	3C	45
DOOR (Pin 41)	04	0D	16	1D		2E	36	3D	46
CDC1 (Pin 11)	05	0E	17	1E	26		37	3E	47
CDC2 (Pin 12)	06	0F	18	1F	27	2F		3F	48
MIC (Pin 26)	07	10	78	20	28	30	38		49
BEEP (Pin 6)	08	11	19	21	29	4F		40	
ALC (internal)	09	12				31	39	41	

Other Addresses (hexadecimal values)

Address	Mode
00	Reset control (Default state: all D values are set to 0.)
4A	ALC control (D = 1: ALC off, D = 0: ALC on)
4B	TR-CNT control (D = 1: pin 5 = low, D = 0: pin 5 = high)
4C	OSC-SW control (D = 1: switch on, D = 0: switch off)
4D	MIC-ATT control (D = 1: level = -6 dB, D = 0: level = 0 dB)
7F	PA-CNT control (D = 1: pin 4 = low D = 0: pin 4 = high)
50	Electronic volume control: LVL0 (0 dB: Default position)
51	Electronic volume control: LVL1 (-2 dB)
52	Electronic volume control: LVL2 (-4 dB)
53	Electronic volume control: LVL3 (-6 dB)
54	Electronic volume control: LVL4 (-8 dB)
55	Electronic volume control: LVL5 (-10 dB)
56	Electronic volume control: LVL6 (-12 dB)
57	Electronic volume control: LVL7 (-14 dB)
58	Electronic volume control: LVL8 (-16 dB)
59	Electronic volume control: LVL9 (-18 dB)
5A	Electronic volume control: LVL10 (-20 dB)
5B	Electronic volume control: LVL11 (-22 dB)
5C	Electronic volume control: LVL12 (-24 dB)
5D	Electronic volume control: LVL13 (-26 dB)
5E	Electronic volume control: LVL14 (-28 dB)
5F	Electronic volume control: LVL15 (-30 dB)
60	DR-ATT: LVL0 (0 dB: Default position)
61	DR-ATT: LVL1 (-3 dB)
62	DR-ATT: LVL2 (-6 dB)
63	DR-ATT: LVL3 (-9 dB)
64	CDC1-ATT: LVL0 (0 dB: Default position)
65	CDC1-ATT: LVL1 (-3 dB)
66	CDC1-ATT: LVL2 (-6 dB)
67	CDC1-ATT: LVL3 (-9 dB)
68	CDC2-ATT: LVL0 (0 dB: Default position)
69	CDC2-ATT: LVL1 (-3 dB)
6A	CDC2-ATT: LVL2 (-6 dB)
6B	CDC2-ATT: LVL3 (-9 dB)
6C	OSC-ATT: LVL0 (0 dB: Default position)
6D	OSC-ATT: LVL1 (-5 dB)
6E	OSC-ATT: LVL2 (-10 dB)
6F	OSC-ATT: LVL3 (-15 dB)
70	LN-ATT: LVL0 (0 dB: Default position)
71	LN-ATT: LVL1 (-4 dB)
72	LN-ATT: LVL2 (-8 dB)
73	LN-ATT: LVL3 (-12 dB)
74	HD-ATT: LVL0 (0 dB: Default position)
75	HD-ATT: LVL1 (-6 dB)
76	HD-ATT: LVL2 (-12 dB)
77	HD-ATT: LVL3 (-18 dB)

Usage Notes

1. Splatter filter (compressor system filter) cutoff frequency

The cutoff frequency is set by the resistor connected between pin 31 and ground. (See graph 1.)

However, to set the value of the cutoff frequency precisely, use two resistors and design the circuit for the desired frequency.

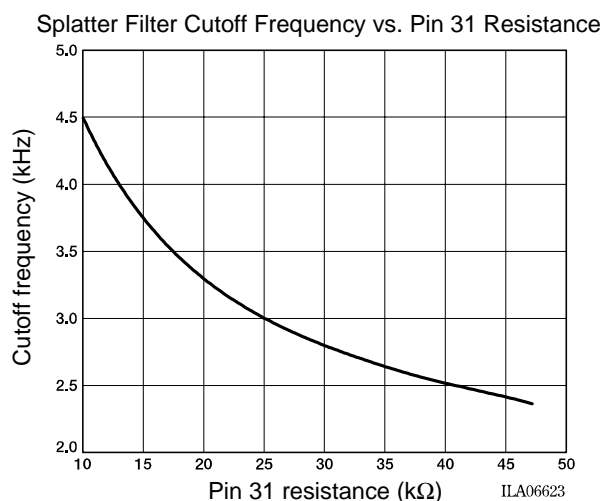

Graph 1

2. Expander system and CODEC system input filters

The cutoff frequency is determined by constructing a multiple feedback type filter using external resistor and capacitor components and the built-in amplifier. The external component values can be determined easily from the values of a standardized circuit. The capacitor value that gives the target cutoff frequency is determined by using the circuit constants shown in table 1 and making the values of all the resistors used the same. However, since capacitors are not available in close value increments, it is necessary to select an approximate value for the capacitor and as the final step, adjust the frequency setting precisely with the resistor values. This means that in the final design, all the resistors may not have the same value.

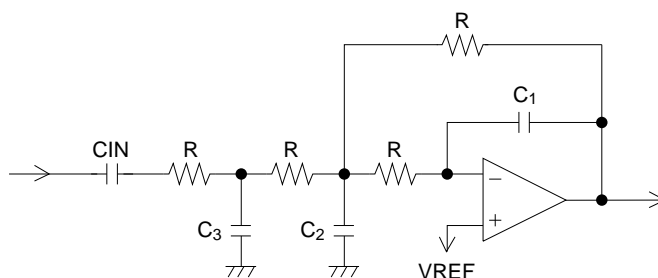

Figure 1

Formula: $C_a = X_a / 2\pi R f_c$

Table 1. Standardized Circuit Constants

Type of low-pass filter	X1	X2	X3
Second-order Butterworth	0.4714	2.1213	—
Third-order Butterworth	0.3333	3.0000	1.0000
Second-order Bessel	0.4531	1.3594	—
Third-order Bessel	0.3327	1.4298	0.7548

Note that there is no concept of 3 dB attenuation for the Bessel filter cutoff frequency. The 3 dB attenuation frequency is 1.38 times f_c for a second-order filter and 1.75 times f_c for a third-order filter.

3. Preemphasis and deemphasis

The preemphasis system (first-order high-pass filter) is formed by the CMP preamplifier block input coupling capacitor, and the deemphasis system (first-order low-pass filter) is formed by the RF1 input amplifier feedback capacitor.

4. Full-wave rectification smoothing capacitor

The external capacitors on pins 34 and 46 are used for smoothing the compressor and expander full-wave rectifier circuits. These capacitors determine both the smoothing characteristics and the time constant for the transient characteristics. The time constant is determined by the product of this capacitance and the full-wave rectifier circuit 30 k Ω input resistance. While there is a tendency to reduce the time constant on the expander side since this is related to noise that occurs at the end of words in speech, since reducing this value also reduces its smoothing abilities (aggravating output distortion), care is required in determining this value.

5. Compressor AC suppression capacitor

It is necessary to limit the AC feedback so that the DC gain becomes two and the AC gain becomes arbitrarily large in the compressor addition amplifier. Pin 33 is used as the pin to which this suppression capacitor is attached. The cutoff frequency is determined by the product of the capacitance and the 50 k Ω internal resistance.

6. Internal resistors

Designs must take into consideration the $\pm 20\%$ variability in the values of the internal resistors in the pins whose characteristics are determined by both the IC internal impedance and external impedances. These pins include pins 6, 7, 8, 22, 33, 34, and 46.

7. Input block amplifiers (pins 6, 7, 8, 22, 41, and 42)

When the input signal is to be attenuated in an input block amplifier, the signal can be attenuated by the ratio of a resistor inserted in series in the input block and the internal resistor R3.

However, if a large amount of attenuation is required, the value of the series resistor must be increased. As a result, the sample-to-sample variations in the ratio with the internal resistor R3 will increase, resulting in variations in the amount of attenuation. To reduce such variations as much as possible, we recommend attenuating the signal using two resistors as shown in figure 2.

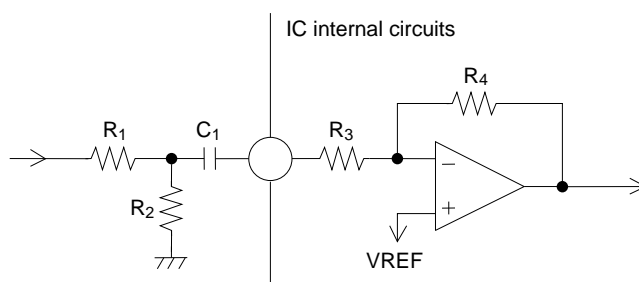

Figure 2

8. Microphone amplifier

If this amplifier is used as a noninverting amplifier, to maintain circuit balance, we recommend using the same value resistors for the bias resistor (between pins 28 and 29) and the feedback resistor (between pins 26 and 27).

However, if used as an inverting amplifier, using the same value for the bias and feedback resistors may increase output noise. In this case, we recommend using 0 Ω for the bias resistor (that is, shorting pins 28 and 29 together).

9. ALC (automatic level control) circuit

To improve the ALC width characteristics, the signal is attenuated (by about -16.7 dB) in the ALC circuit front end. The ALC preamplifier gain must be set with that in mind.

If the ALC function is not used, leave pin 53 open and short pin 50 to ground.

10. Control output pins (pins 4 and 5)

These output pins are current output pins, and have current capacities of about $30 \pm 10 \mu\text{A}$ of source current and over $100 \mu\text{A}$ of sink current. As a result, pull-down resistors are required if these pins are used to control voltage mode type input ports such as MOS transistors.

If either of these pins is unused, it must be shorted to ground to assure the source current path.

11. Control input pins (pins 2, 3, 62, 63, and 64)

Since the internal pin circuits include both a pull-down resistor and an input current limiting resistor and furthermore the high side protection diode has been eliminated, the LA8580W can be directly connected to the controlling microcontroller even if the supply voltages differ.

However, when directly connected to the microcontroller output ports, the LA8580W substrate is affected, and the signal-to-noise ratio may be degraded. Thus we recommend inserting series resistors with a value of about $1 \text{ k}\Omega$ to $2.2 \text{ k}\Omega$.

12. Power on reset pin (pin 61)

The power on reset function is enabled by adding a capacitor between pin 61 and ground and a pull-up resistor to V_{CC} (sample values: $10 \mu\text{F}$, $100 \text{ k}\Omega$). This allows all the IC mode settings to be set to their default states when power is first applied. However, to reduce the number of external components, we recommend using serial control of address 00 to perform a reset at least 200 ms after power is first applied.

However, note that since no serial control operations can be performed if this pin is left at the low level, the external pull-up resistor is required even if the power on reset function is not used.

Although this pin can be used as an independent reset pin controlled by the microcontroller, an input current limiting resistor inserted in series is absolutely required for connection with the microcontroller. (This is the only case where the pull-up resistor is not required, since the current can be supplied by the microcontroller port.)

13. Parallel control mode

The compressor/expander system muting control adopts an independent parallel control technique.

Pin No.	Pin	Low or open	High
2	CMP-MUTE	Compressor system audio: muted	Compressor system audio: normal output
3	EXP-MUTE	Expander system audio: muted	Expander system audio: normal output

14. Data shaper threshold

The built-in data shaper can support either a fixed threshold or threshold following operation depending on the application circuit at pin 60.

(1) Threshold following: Insert a capacitor between pin 60 and ground (following function internal bias resistor: $50 \text{ k}\Omega$).

(2) Fixed threshold: Connect pin 60 to ground.

15. VOX (voice signal level detection) circuit

The VOX circuit consists of an input block amplifier that sets the sensitivity, a full-wave rectifier that rectifies that signal, and comparator that compares the rectified voltage. The smoothing capacitor for the full-wave rectifier is connected to pin 56. Since the ripple component increases and an AC component may be output from the VOX circuit if that capacitor is too small, a capacitor of $0.47 \mu\text{F}$ or greater must be used.

If the VOX circuit is not used, short pins 54 and 55 together, and connect pins 56 and 57 to ground.

16. ESD protection diode

The ESD protection diodes have been removed from the control pin and data output pin circuits to allow these pins to be connected directly to the microcontroller. However if the microcontroller input and output ports are connected directly, the LA8580W substrate may be affected and that can lead to degradation of the signal-to-noise ratio. To avoid this problem, we recommend the insertion of series resistors with a value of about $1 \text{ k}\Omega$ to $2.2 \text{ k}\Omega$.

Pins with no protection diodes: V_{CC1} (pin 9), V_{CC2} (pin 58), GND1 (pin 40), and GND2 (pin 1)

Pins with only low side protection diodes: Pin 2, 3, 4, 5, 57, 59, 61, 62, 63, 64

Pins with only high side protection diodes: All other pins

17. Crosspoint switch system dynamic range

The overall dynamic range of the LA8580W built-in crosspoint switch is determined by the following two factors.

- The dynamic range of the analog switch itself (ability: -1.5 dBV, limiting value: -5 dBV)
- Dynamic range due to the output amplifier output current capability (when the output load resistance R_L is $10\text{ k}\Omega$)
 1. ALC (ability: -0.5 dBV, limiting value: -5 dBV \Rightarrow when the ALC circuit is off)
 2. LN, CDC1, CDC2, OP1, and OP2 system outputs (ability: -3.5 dBV, limiting value: -7.5 dBV = 0.0178 mW)
 3. HD, RF1, RF2, DR, and VOL system outputs (ability: -6 dBV, limiting value: -10 dBV = 0.01 mW)

Which is to say, other than the ALC amplifier, the crosspoint switch dynamic range is dominated by the output current capabilities of the output stage amplifiers. Therefore, except for the ALC amplifier, the dynamic range rating is due to the maximum power of the output blocks.

Therefore, due to the above, a normal dynamic range rating would be as follows.

- ALC amplifier output dynamic range $\Rightarrow -5.0$ dBV
- Line and DSP system output dynamic range $\Rightarrow -7.5$ dBV
- Dynamic range of all other output systems $\Rightarrow -10$ dBV

However, for lighter loads, the LA8580W can provide amplitudes of up to -5 dBV. Therefore, we recommend taking the input impedance of the receiving system into consideration. We also recommend expanding the amplitude by inserting resistors between the output pins and ground to increase the current capability.

18. Pin shorting

The LA8580W may be damaged or destroyed if power is applied with any pairs of IC pins shorted together. Always verify that there is no solder or other foreign matter on the PWB that could short IC pins together before applying power.

19. Load shorting

The LA8580W may be damaged or destroyed if operated with the load shorted for extended periods. Do not short the LA8580W loads.

20. Maximum ratings

If the LA8580W is operated in the vicinity of the maximum ratings, those ratings may be exceeded by even the slightest change in the operating conditions, and the IC may be damaged or destroyed. LA8580W applications must be designed so that adequate margins are provided for supply voltage and other operating condition variations so that the maximum ratings are never exceeded.

Crosspoint Switch System Level Diagram (For reference purposes)

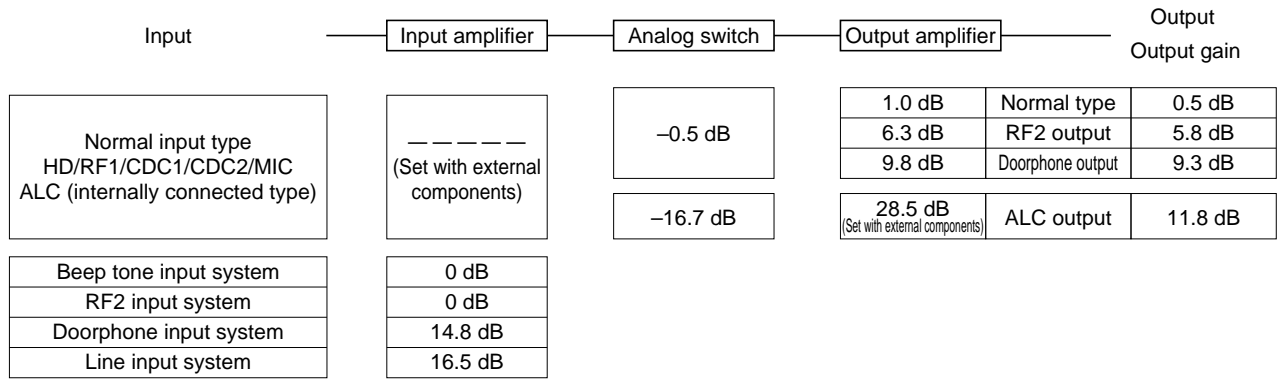

Componder System Level Diagram (For reference purposes)

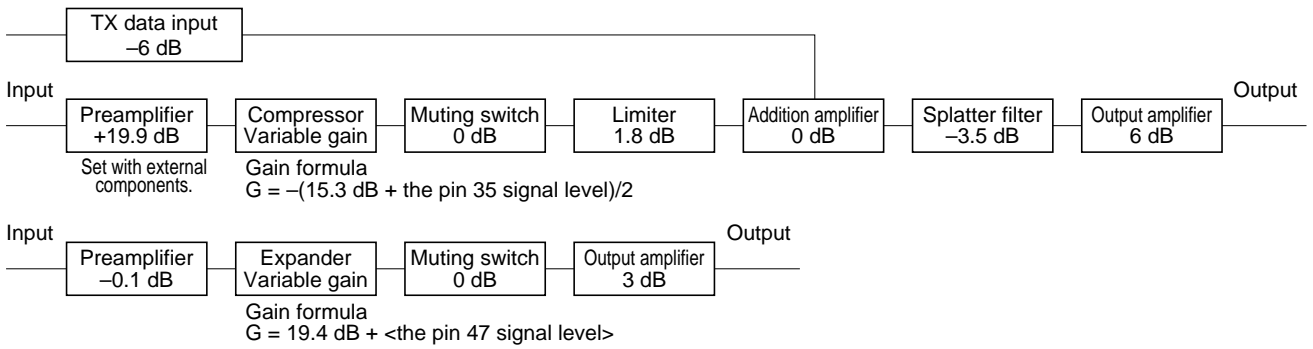

LA8580W

Pin Functions

Pin No.	Pin Name	Pin Voltage	Remarks	Equivalent circuit
1	GND2	—	Ground 2	
2	CMP-MUTE	0	Transmit system audio mute control	
3	EXP-MUTE		Receive system audio mute control	
4	PA-CNT	1.4 (When a 33 kΩ resistor has been inserted between this pin and ground)	Control output	
5	TR-CNT		Control output	
6	BEEP-IN	2.5	Beep tone input	
7	OSC-IN		Oscillator input	
8	TX-DATA-IN	2.5	Transmit data input	
9	V _{CC1}	Applied supply voltage	Power supply 1	
10	CDCA1-IN	2.5	Codec 1 amplifier input	
11	CDCA1-OUT		Codec 1 amplifier output	
12	CDCA2-OUT		Codec 2 amplifier output	
13	CDCA2-IN		Codec 2 amplifier input	
16	CDC1-OUT	2.5	CDC1 output	
17	CDC2-OUT		CDC2 output	

Continued on next page.

LA8580W

Continued from preceding page.

Pin No.	Pin Name	Pin Voltage	Remarks	Equivalent circuit
14	OP1-OUT	2.5	OP1 amplifier output	
15	OP1-IN		OP1 amplifier input	
18	OP2-IN		OP2 amplifier input	
19	OP2-OUT		OP2 amplifier output	
43	RF1-OUT		RF1 amplifier output	
44	RF1-IN		RF1 amplifier input	
54	VOXA-IN		VOX amplifier input	
55	VOXA-OUT		VOX amplifier output	
20	HAND-OUT	2.5	Handset amplifier output	
21	HAND-IN		Handset amplifier input	
22	LINE-IN	2.5	Line input	
23	LINE-OUT	2.5	Line output	
24	HAND-OUT		Handset output	
25	VOL-OUT		Electronic volume control output	
26	MIC-OUT	2.5	Microphone amplifier output	
27	MIC-NF		Microphone amplifier minus output	
28	MIC-IN		Microphone amplifier plus output	
29	VREF	2.5	Internal reference voltage output	
30	VBGP	1.2		
31	FREQ-SET	0.2	Splatter filter cutoff frequency setting	

Continued on next page.

LA8580W

Continued from preceding page.

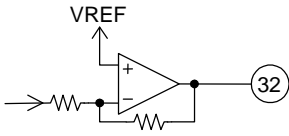
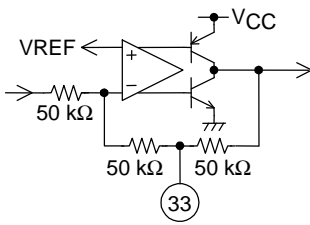
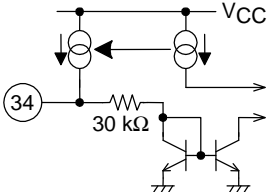
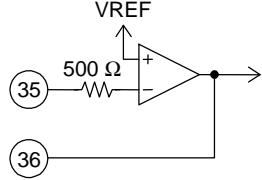
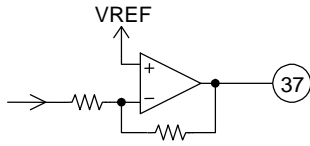
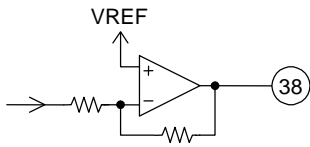
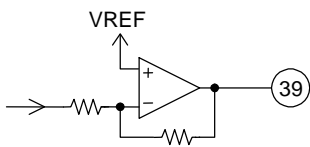
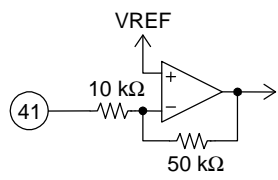
Pin No.	Pin Name	Pin Voltage	Remarks	Equivalent circuit
32	CMP-OUT	2.6	CMP output	
33	CMP-NF	2.5	Compressor addition amplifier AC feedback suppression	
34	CMP-RCT	Undefined (when no input signal is present)	Compressor circuit full-wave rectifier circuit output block	
35	CPRE-OUT	2.5	CMP preamplifier output	
36	CPRE-IN		CMP preamplifier input	
37	RF1-OUT	2.5	RF1 output	
38	RF2-OUT	2.5	RF2 output	
39	DOOR-OUT	2.5	Doorphone output	
40	GND1	—	Ground 1	
41	DOOR-IN	2.5	Doorphone input	

Continued on next page.

LA8580W

Continued from preceding page.

Pin No.	Pin Name	Pin Voltage	Remarks	Equivalent circuit
42	RF2-IN	2.5	RF2 input	
45	EXP-OUT	2.5	Expander output	
46	EXP-RCT	Undefined (when no input signal is present)	Expander circuit full-wave rectifier circuit output block	
47	EXP-IN	2.5	Expander input	
48	EPRE-OUT	2.5	EXP preamplifier output	
49	EPRE-IN		EXP preamplifier input	
50	ALC-CNT	0 (when no input signal is present)	ALC time constant setting	

Continued on next page.

LA8580W

Continued from preceding page.

Pin No.	Pin Name	Pin Voltage	Remarks	Equivalent circuit
51	ALC-PRE-NF	2.5	ALC preamplifier minus input	
52	ALC-OUT		ALC output	
53	ALC-IN	2	ALC input	
56	VOX-RCT	0 (when no input signal is present)	VOC circuit full-wave rectifier circuit output	
57	VOX-OUT	4.97 (when no input signal is present)	Comparator output	
58	V _{CC2}	Applied supply voltage	Power supply 2	
59	FSK-OUT	Undefined (when no input signal is present)	Data shaper output	
60	DS-TH	2.5	Data shaper threshold following/fixed threshold control	
61	RESET	0.78 (Current insertion)	Reset	
62	CE	0	Chip enable input	
63	DT		Data input	
64	CL		Clock input	

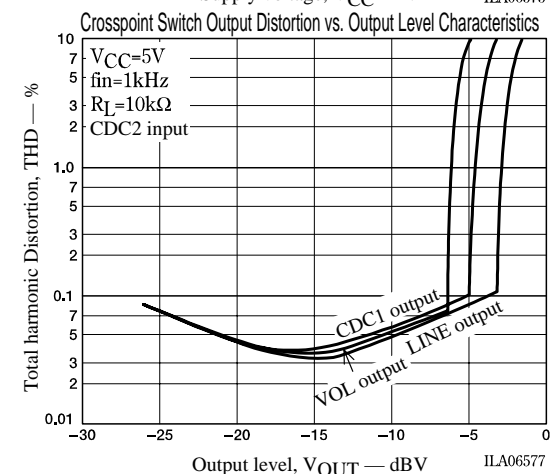
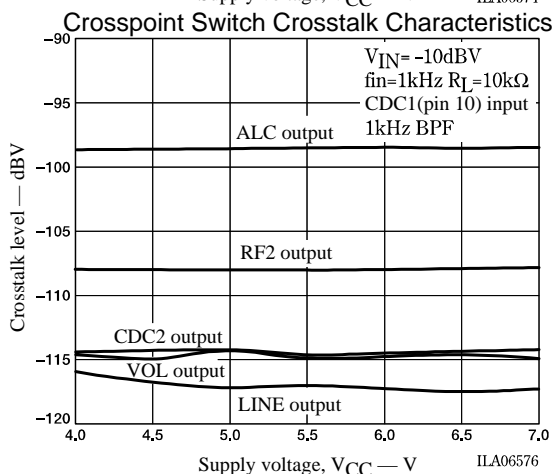
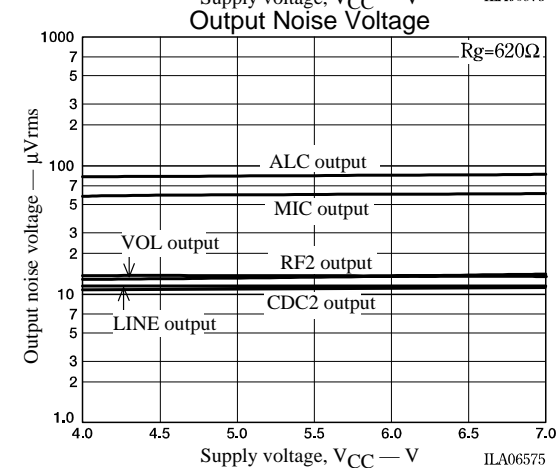
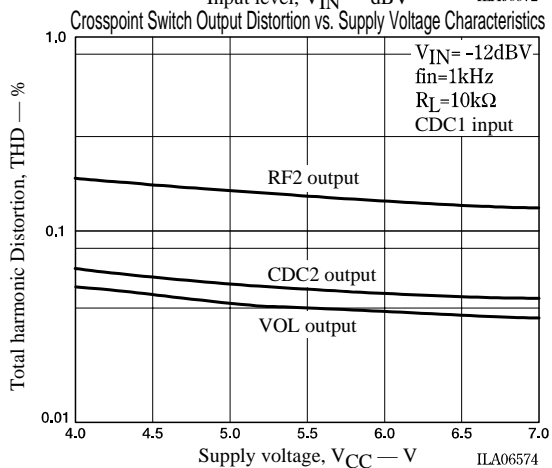
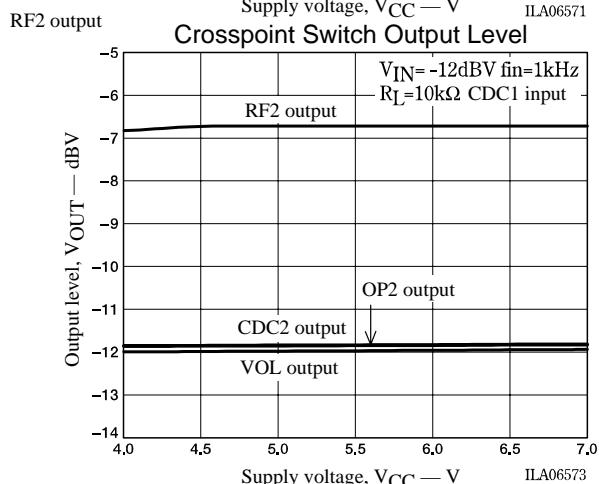
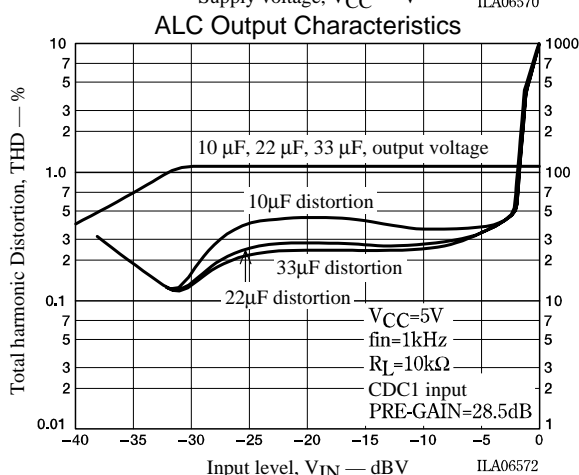
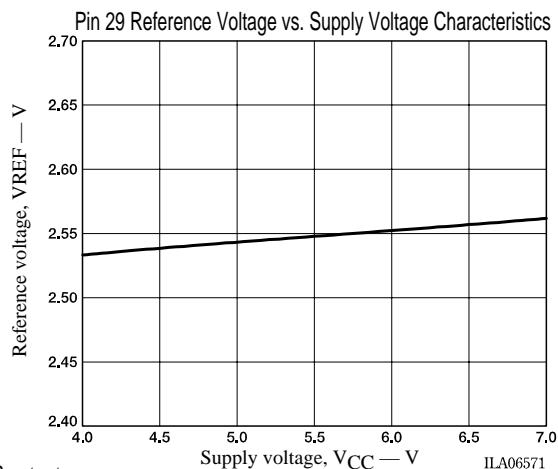
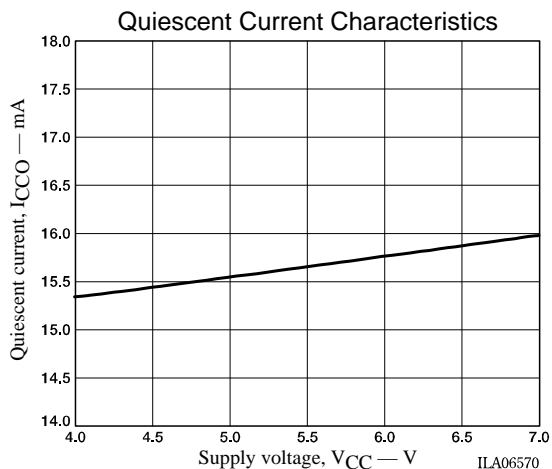

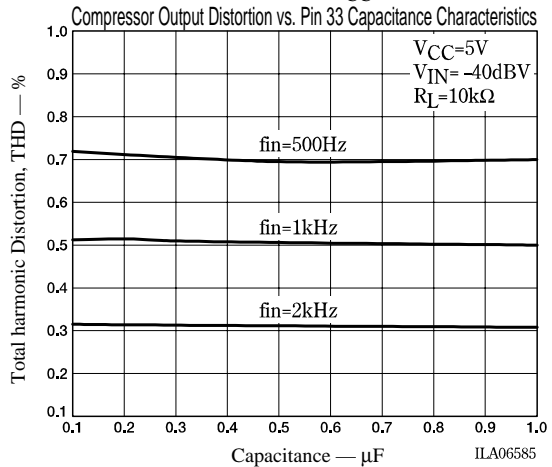
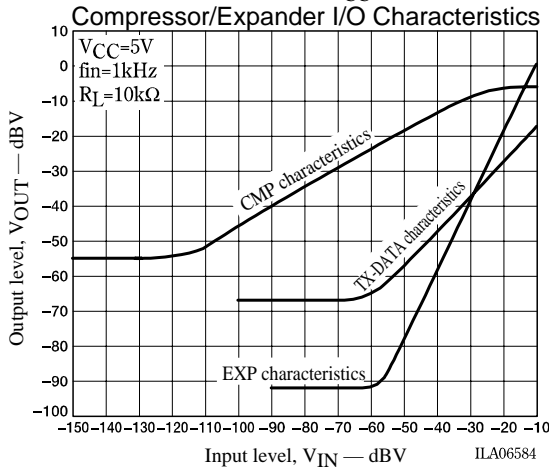
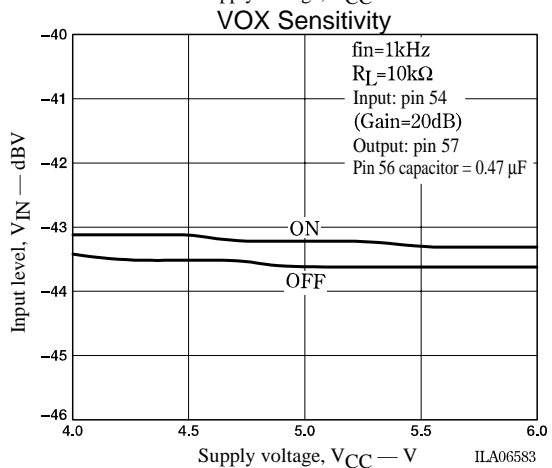
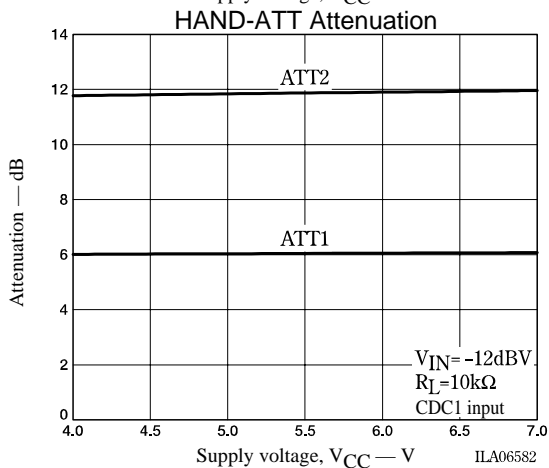
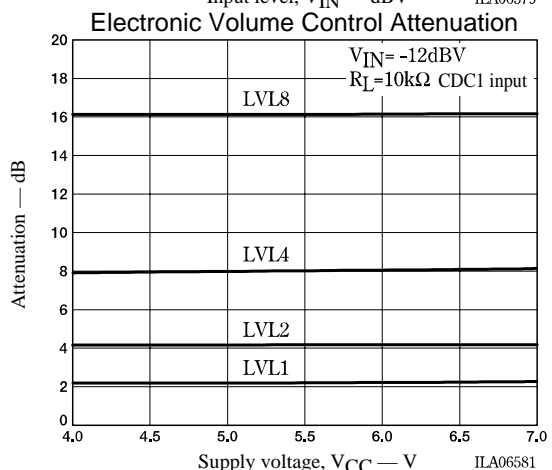
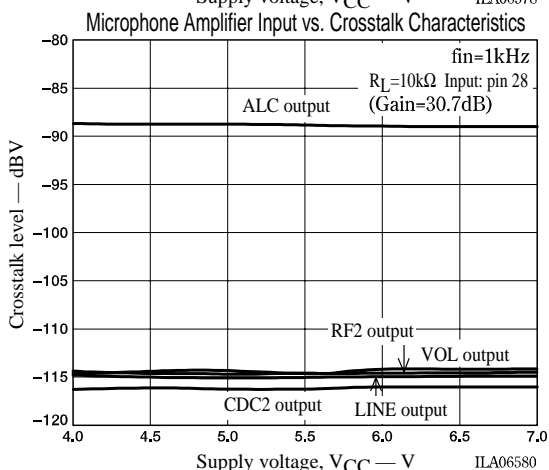
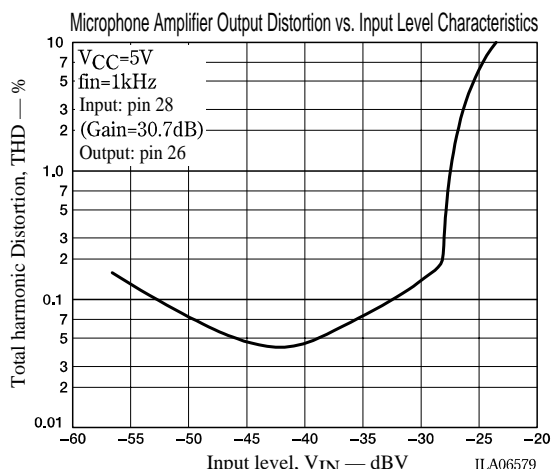
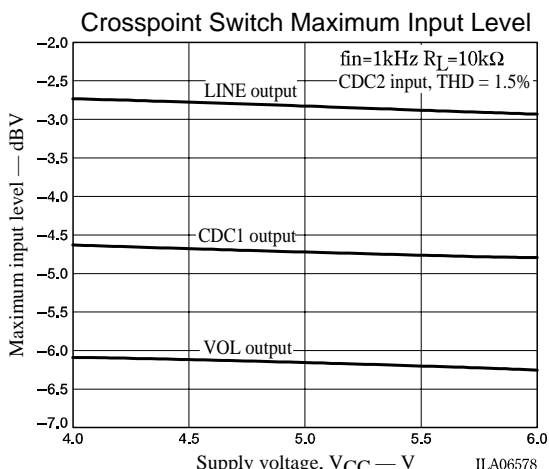

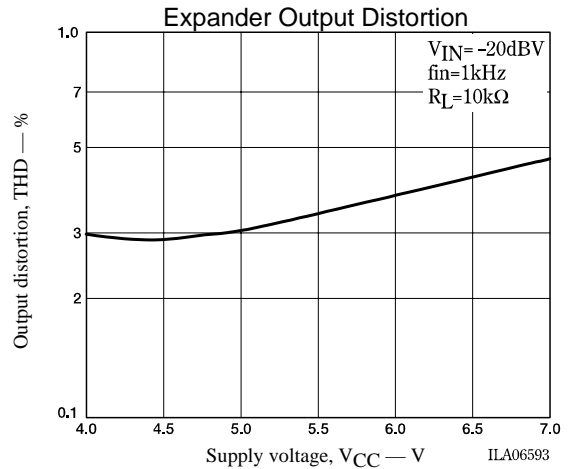
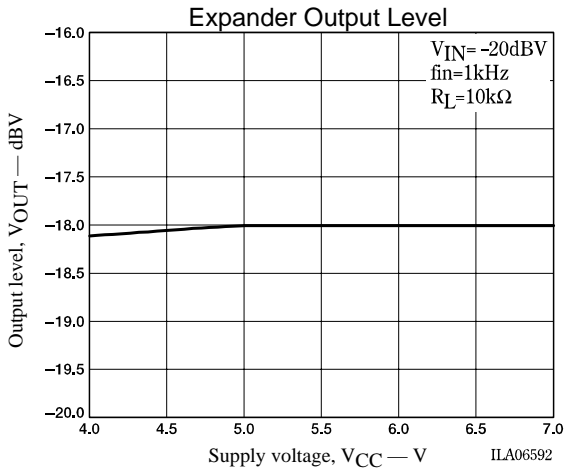
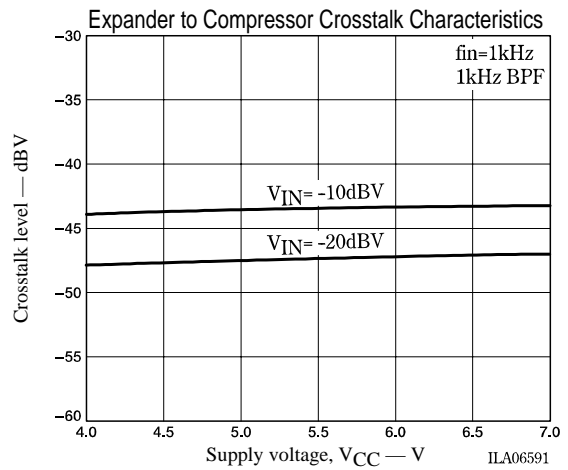
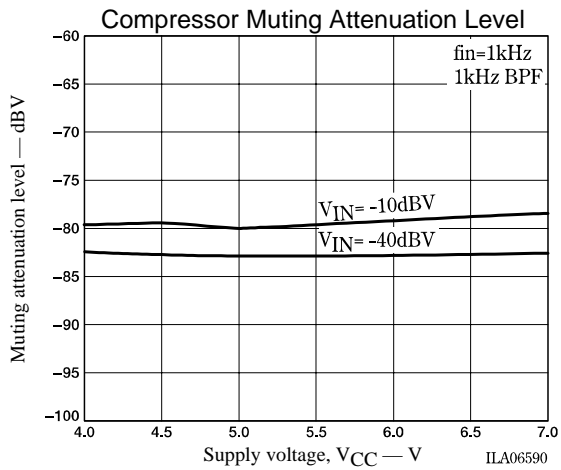
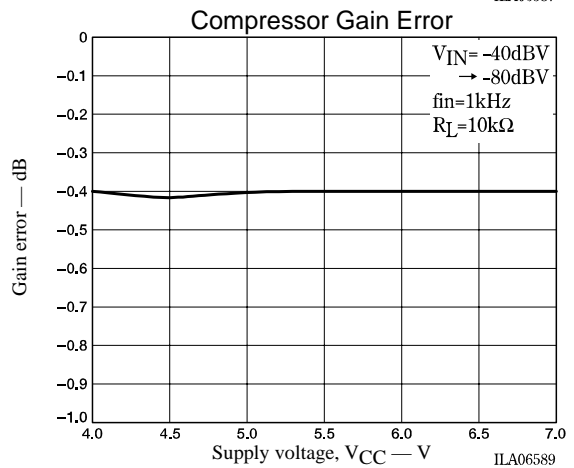
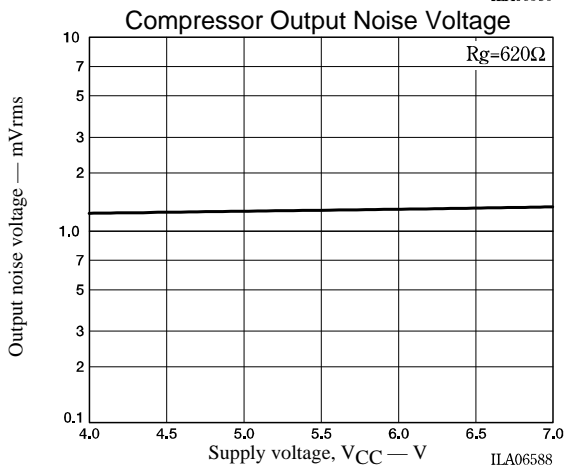
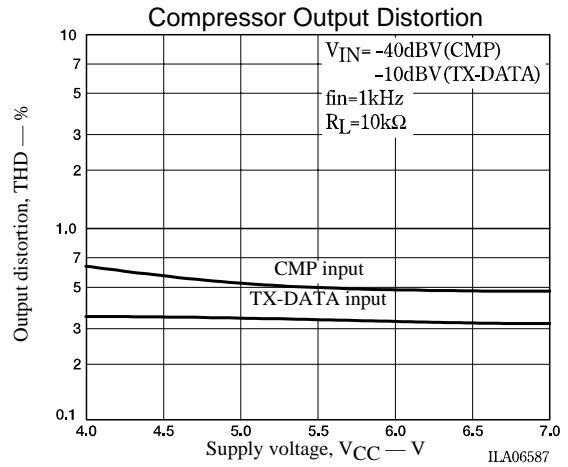
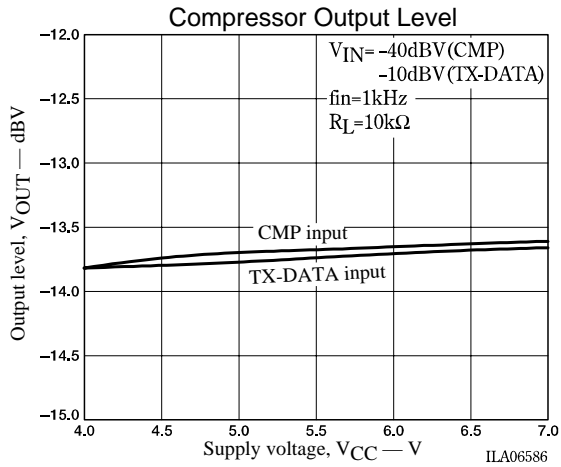

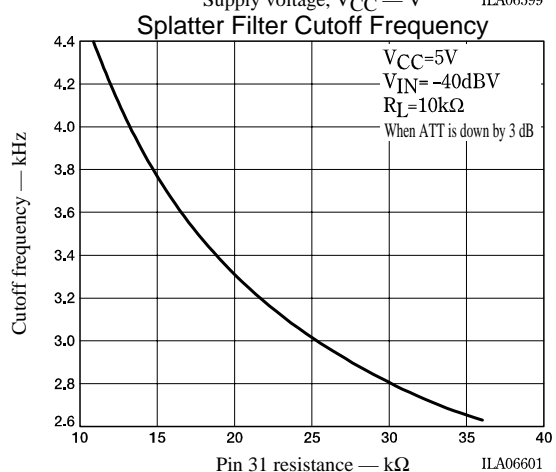
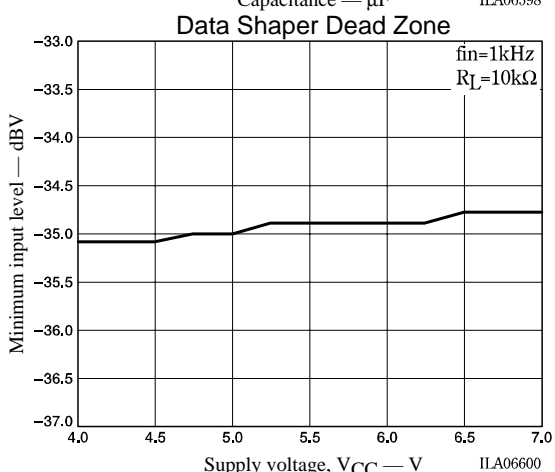
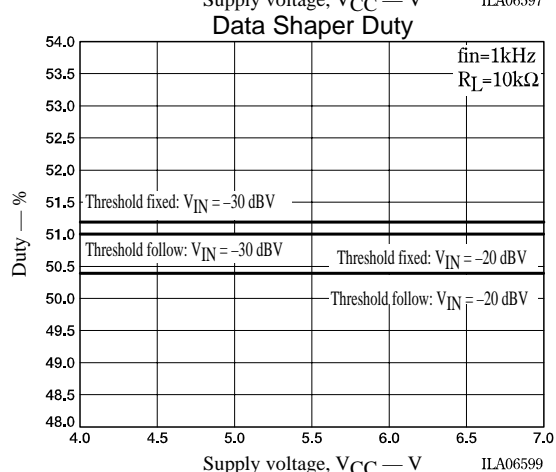
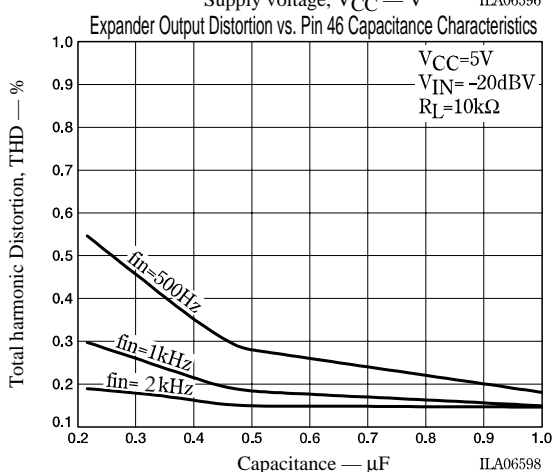
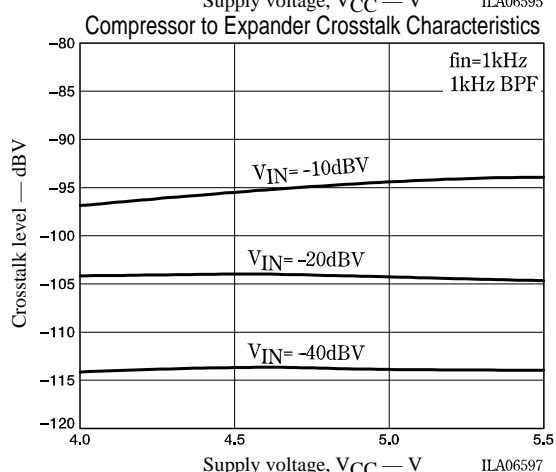
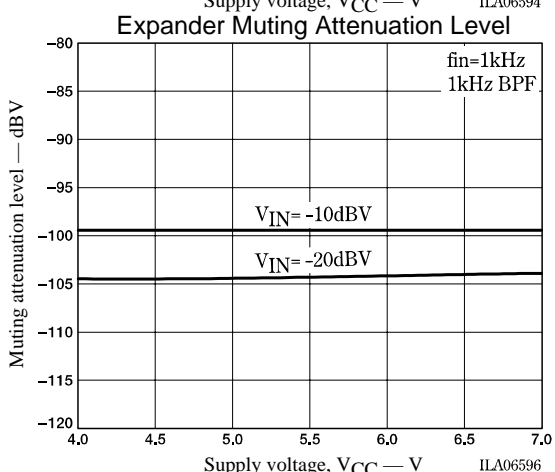
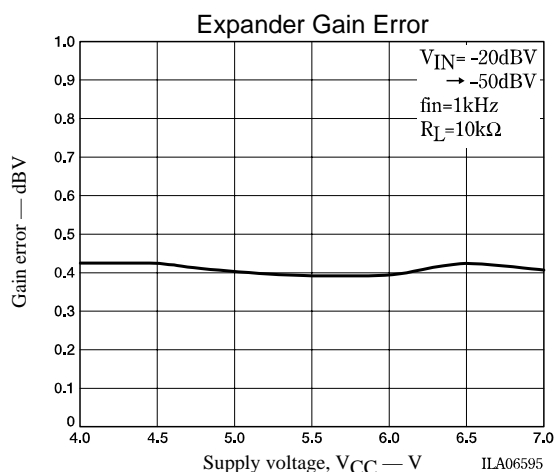
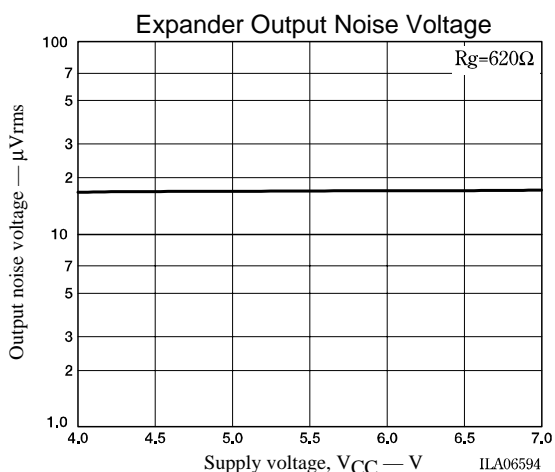

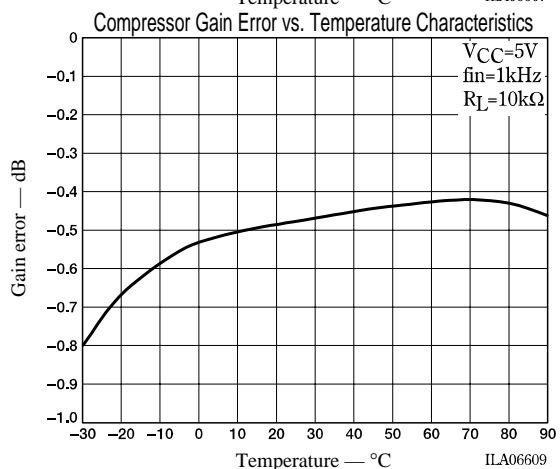
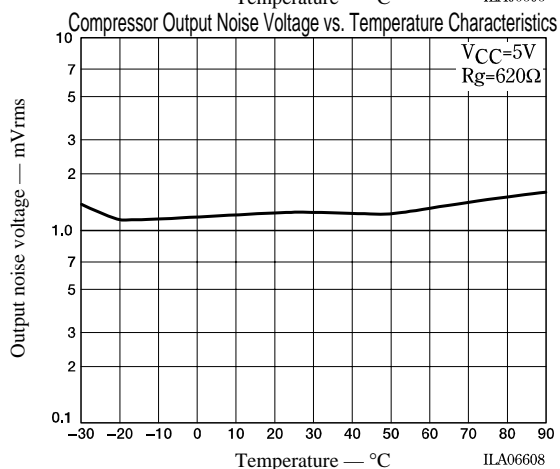
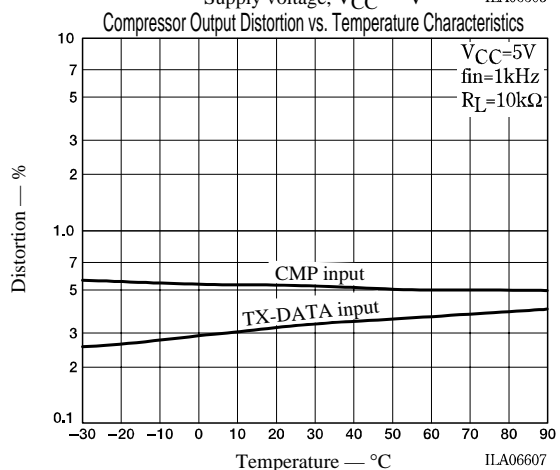
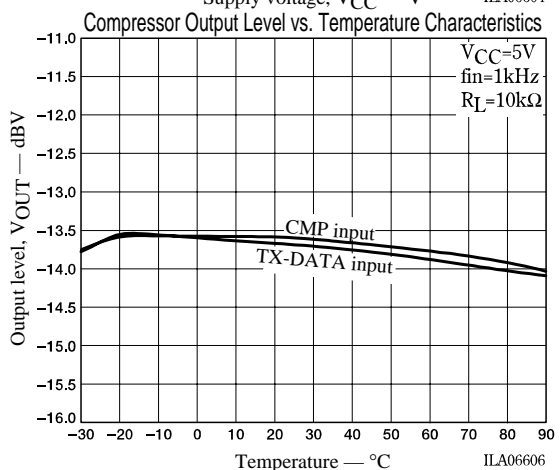
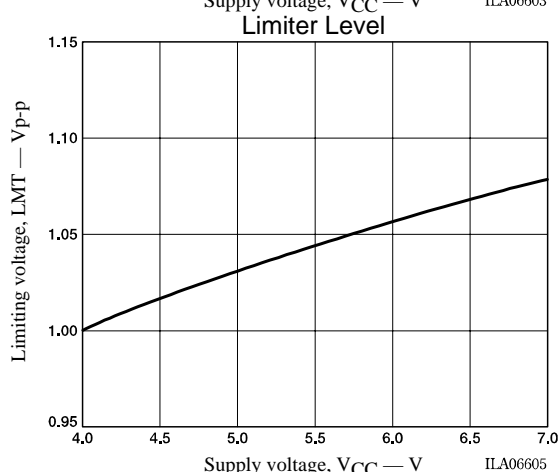
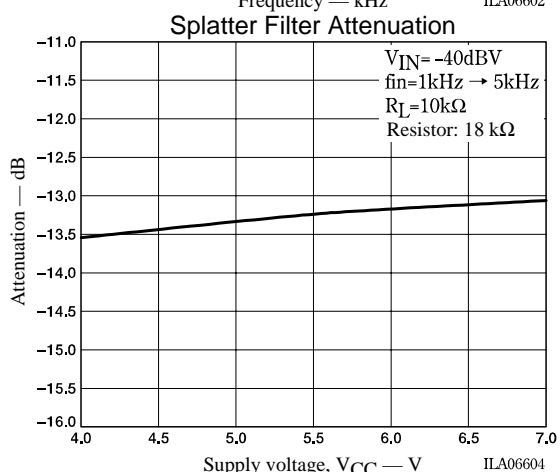
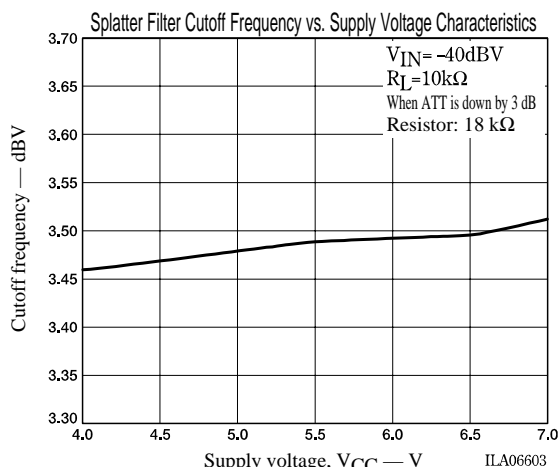
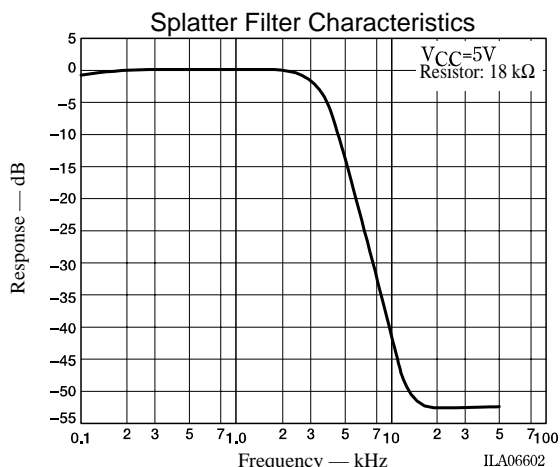

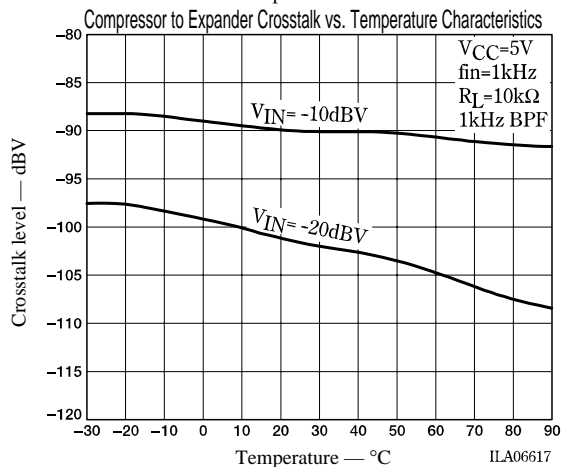
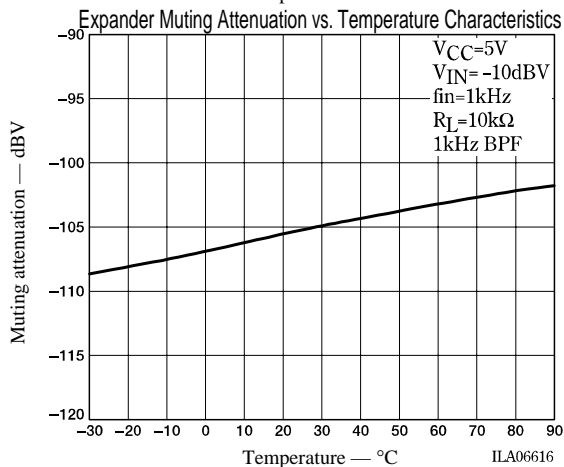
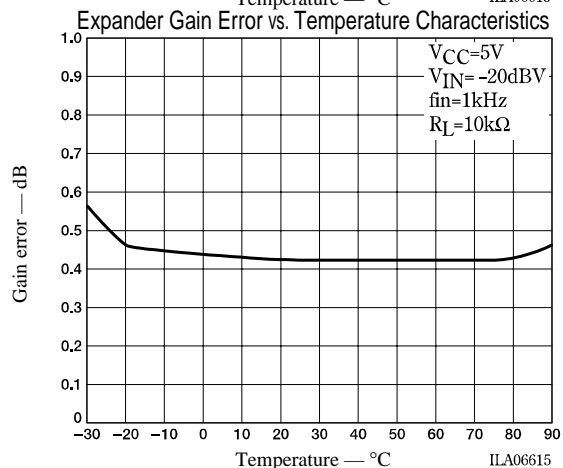
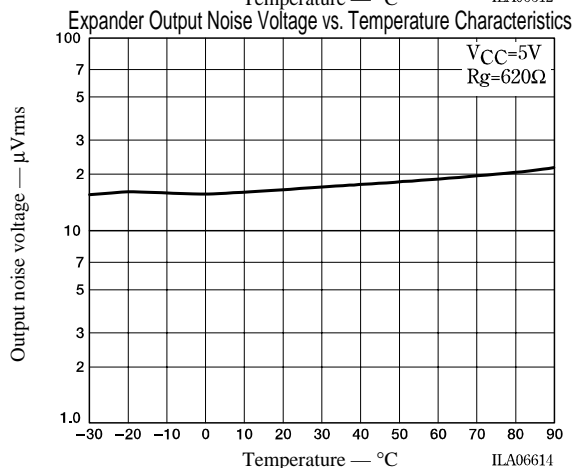
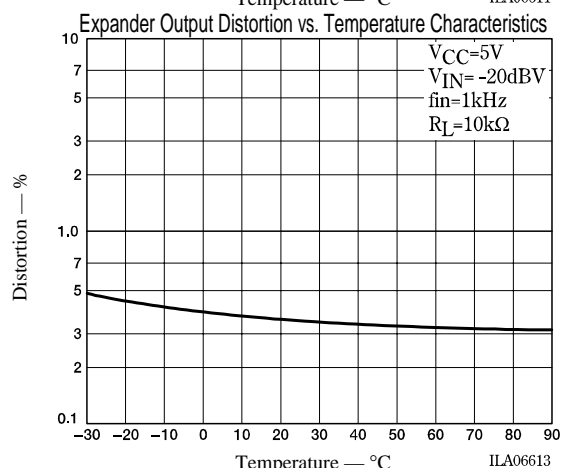
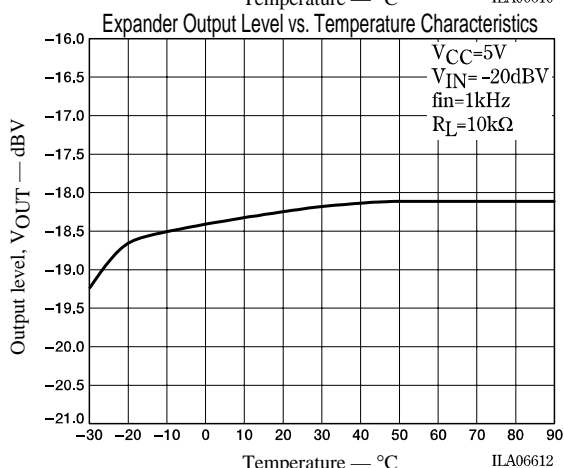
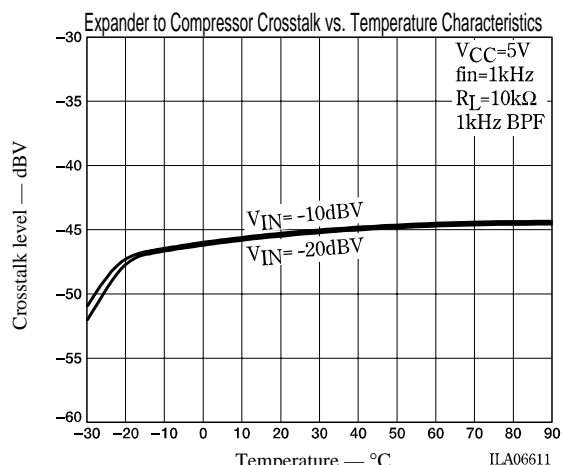
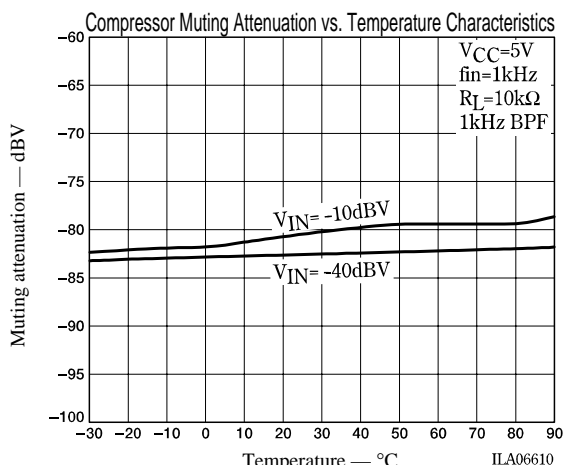

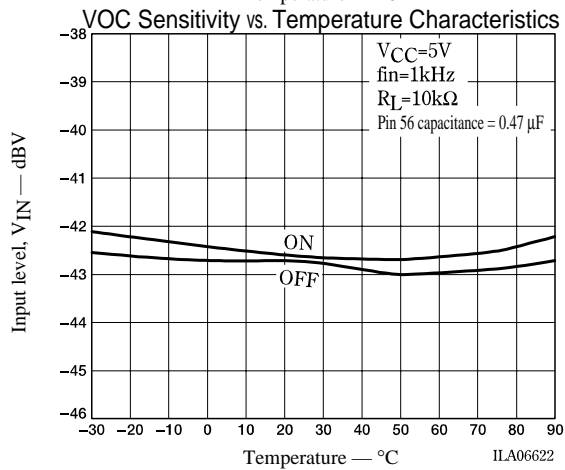
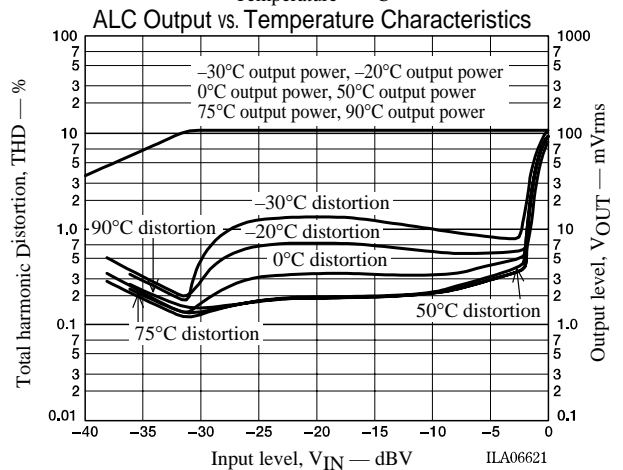
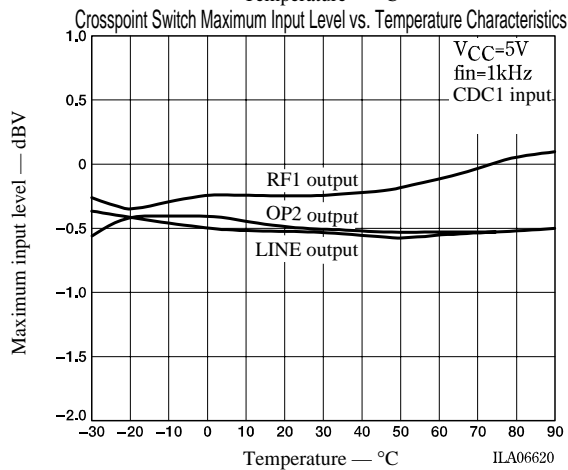
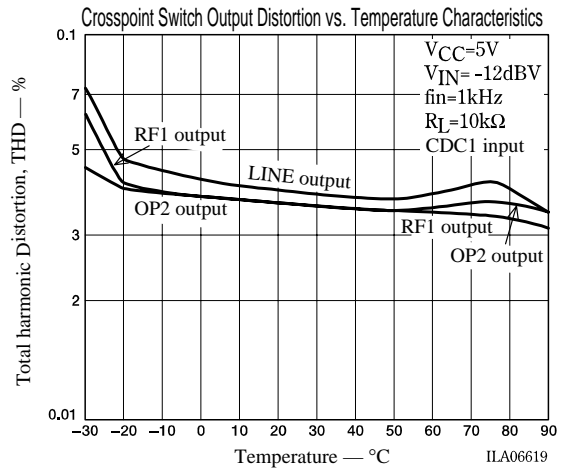
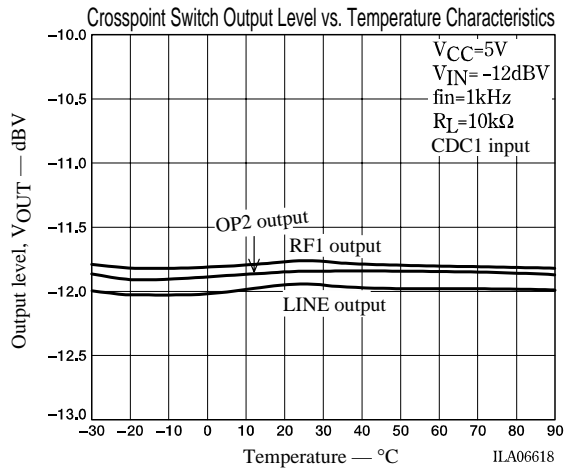

- Specifications of any and all SANYO products described or contained herein stipulate the performance, characteristics, and functions of the described products in the independent state, and are not guarantees of the performance, characteristics, and functions of the described products as mounted in the customer's products or equipment. To verify symptoms and states that cannot be evaluated in an independent device, the customer should always evaluate and test devices mounted in the customer's products or equipment.
- SANYO Electric Co., Ltd. strives to supply high-quality high-reliability products. However, any and all semiconductor products fail with some probability. It is possible that these probabilistic failures could give rise to accidents or events that could endanger human lives, that could give rise to smoke or fire, or that could cause damage to other property. When designing equipment, adopt safety measures so that these kinds of accidents or events cannot occur. Such measures include but are not limited to protective circuits and error prevention circuits for safe design, redundant design, and structural design.
- In the event that any or all SANYO products (including technical data, services) described or contained herein are controlled under any of applicable local export control laws and regulations, such products must not be exported without obtaining the export license from the authorities concerned in accordance with the above law.
- No part of this publication may be reproduced or transmitted in any form or by any means, electronic or mechanical, including photocopying and recording, or any information storage or retrieval system, or otherwise, without the prior written permission of SANYO Electric Co., Ltd.
- Any and all information described or contained herein are subject to change without notice due to product/technology improvement, etc. When designing equipment, refer to the "Delivery Specification" for the SANYO product that you intend to use.
- Information (including circuit diagrams and circuit parameters) herein is for example only; it is not guaranteed for volume production. SANYO believes information herein is accurate and reliable, but no guarantees are made or implied regarding its use or any infringements of intellectual property rights or other rights of third parties.

This catalog provides information as of March, 2004. Specifications and information herein are subject to change without notice.