

## Emergency Stop Switch

## A3GE

### Separate Unit Type 16mm Cylindrical Series

- Contact gap more than 3mm.
- Button size 30mm and 40mm.
- Snap-in, snap-out switch units simplify wiring and maintenance.
- Sealed to IEC IP65.
- Complements the A3G range of pushbuttons, selector switches and keyswitches.



### Ordering Information

Push-lock, Turn-reset system avoids misuse.

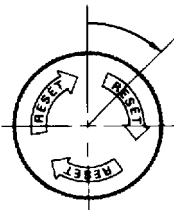

Snap-in action switch unit greatly improves wiring efficiency.

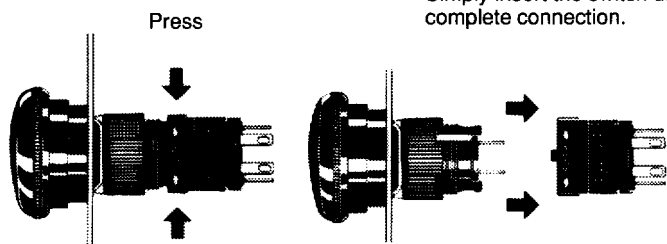

Simply insert the switch unit for complete connection.

Press the part indicated PUSH on the switch unit and pull to remove. Align white marks to insert.

### Specifications

#### ■ Contact

Type	AC resistant load	DC resistant load
General purpose load	AC 250V 3A AC 125V 5A	DC 30V 3A

Operating temperature	-10°C to 55°C (with no icing)
Storage temperature	-25°C to 65°C
Operating temperature	35 to 85% RH

#### ■ LED

Rated voltage	Rated current	Operating voltage
DC 24V	10mA	DC 24V ± 5%

Note: \* LED not mounted  
\*\* Set and reset constitute one operation

#### ■ Characteristics

Item		A3GE
Allowable operating frequency	Mechanical	20 operations/minute max.
	Electrical	10 operations/minute max.
Insulation resistance		100MΩ min. (at 500VDC)
Dielectric strength		2,000VAC, 50/60Hz for 1 minute between terminals of same polarity 2,000VAC, 50/60Hz for 1 minute between terminals of different polarity 4,000VAC, 50/60Hz for 1 minute between each terminal and ground*
Vibration	Malfunction	10 to 55Hz, 1.5mm double amplitude
Shock	Durability	Approx. 500m/s <sup>2</sup> (50G)
	Malfunction	Approx. 300m/s <sup>2</sup> (30G)
Life expectancy**	Mechanical	100,000 operations min.
	Electrical	100,000 operations min.
Weight		Approx. 15g (for 2b contact switches)

Setting force OFA max.	1,500gf (14.7N)
Resetting torque OFR max.	1,000gcm
Lock stroke LTA	2.5±0.5mm

**Terminal Arrangement (Bottom View)**

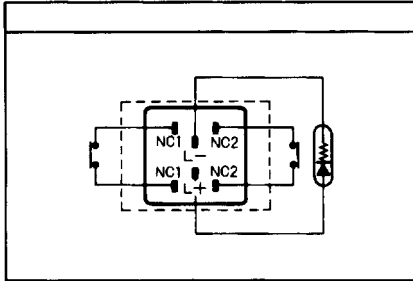

Do not connect No L+ and L- terminals for non-illuminated type

**Structure**

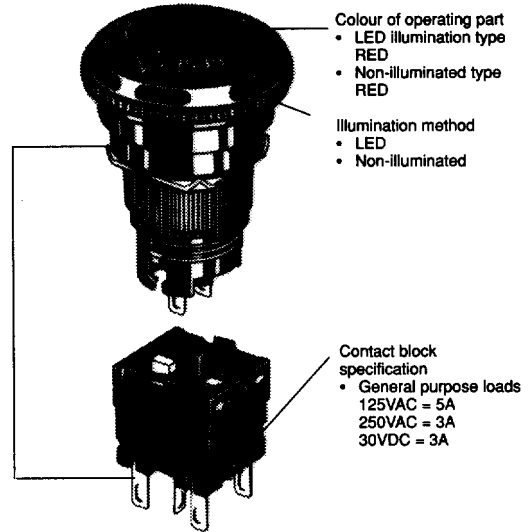

- Colour of operating part
- LED illumination type RED
  - Non-illuminated type RED
- Illumination method
- LED
  - Non-illuminated

- Protective structure and Terminal type
- Protective structure: Oil resistant IP65
  - Terminal type: Solder terminals

- Contact block specification
- General purpose loads
  - 125VAC = 5A
  - 250VAC = 3A
  - 30VDC = 3A

**Dimensions**

**A3GE**

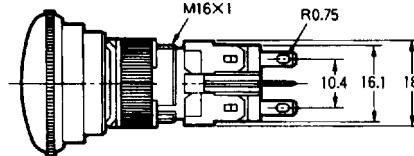
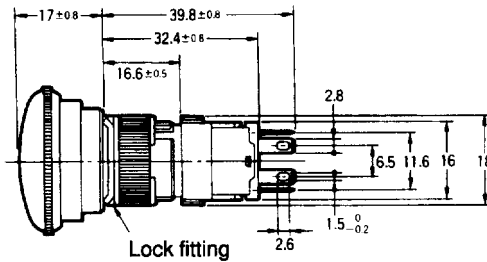
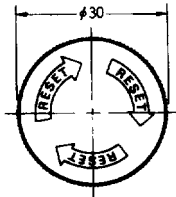
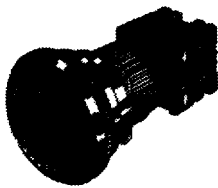

**Panel cutouts**

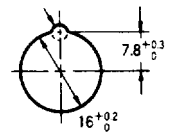

Recommended panel thickness 0.5 to 5.0mm

**A3GE**

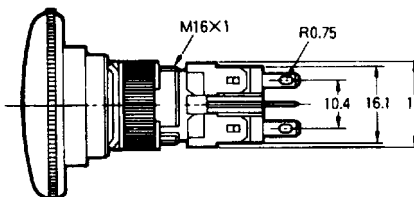
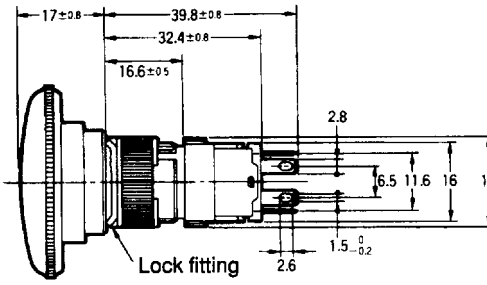
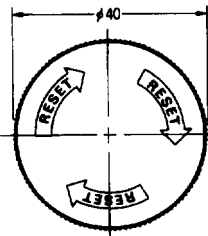
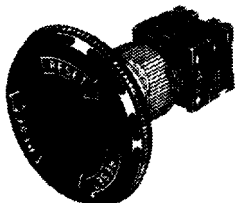

**Panel cutouts**

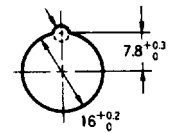

Recommended panel thickness 0.5 to 5.0mm

# How to Order

## Actuator



- 1. Actuator**  
 A3GE-51□-R  
 □ Actuator size and type

## Switch Unit

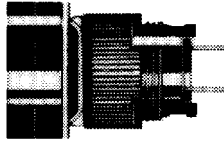

- 2. Switch Unit**  
 A3GE-602□-3  
 Illumination  
 0: Non-illuminated type  
 1: Illuminated type with LED

## Contact Block

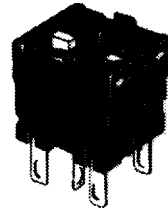

- 3. Contact Block**  
 A3GE-40□1  
 No. of poles  
 1: Single pole  
 2: Double pole

□	Size	Type
0	30mm	Non-illuminated
1		Illuminated
2	40mm	Non-illuminated
3		Illuminated

# Precautions

## Mounting the Panel

After installing the main unit, mount the socket unit from the back of the panel (by snapping into place)

### Installing the main unit

- Attach rubber packing or yellow plate onto the main unit from its terminal side. Insert the main unit into the panel from the front. Install lock fitting and nut from the terminal side and tighten.
- Adjust the slits on the hole of rubber packing and yellow plate to the protuberance on the unit.
- Rubber packing is not necessary when yellow plate is used.
- Tightening torque for the nut must be less than 10kg/cm.
- Case should be installed with its protuberance adjusted to the slit of the hole of the panel.

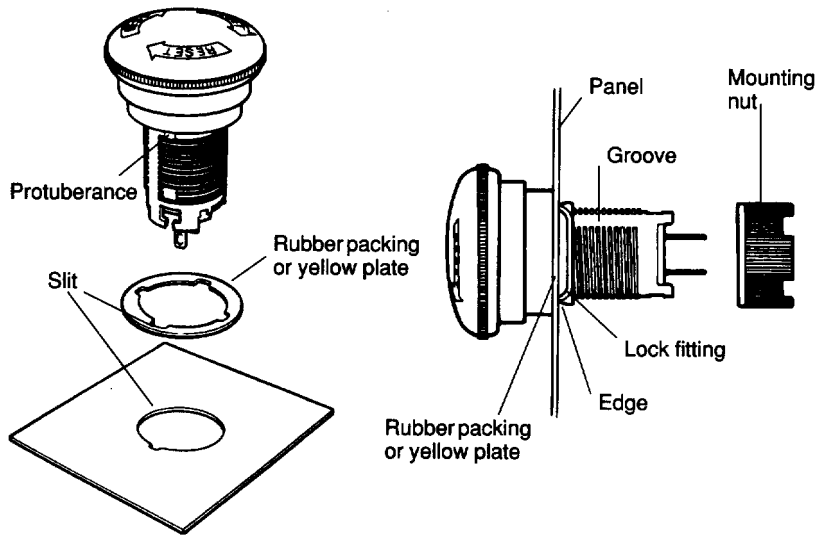

### Mounting the contact block

- Push socket into the main unit.
- There is a direction to fit.
- Adjust the white mark of both main unit and contact block so that they align.

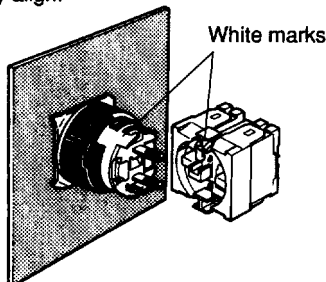

### Removing the contact block

- Press the lock button of the contact block and pull to remove.
- Pull straight, not at an angle.

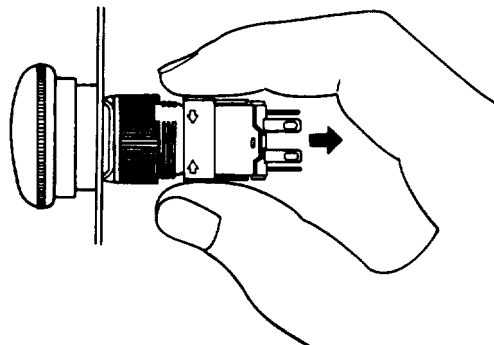

## Mounting and Removing Cap

### Removing the cap

- Turn anti-clockwise at the free position (reset position).

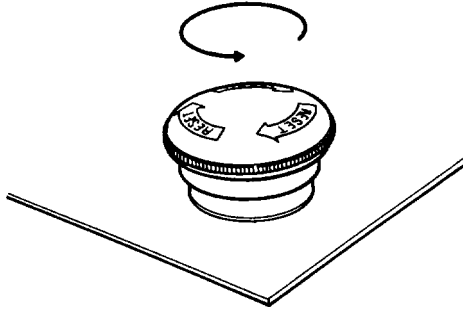

### Mounting the cap

- Turn clockwise until it stops. The tightening torque should be less than 5kg/cm.

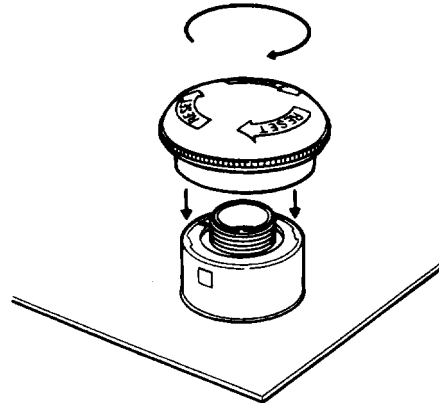

### Mounting

Apply less than 10kg/cm of fastening torque to secure the mounting ring.

### Wiring

When soldering, apply a soldering iron rated at 30W quickly (within 5 secs) or within 3 seconds with a tip temperature of 240°C. Do not apply any external force to the switch for 1 minute after soldering to avoid possible plastic deformation.

Use a non-corrosive resin-type flux.

### Operating environment

The protective structure of the IP65 prevents damage due to dust from the front of the panel into the interior or direct spraying of water from any direction.

### Lamps

Applying a voltage greater than the rated voltage to the lamp terminals will damage the LED.

### Others

The oil-resistant type (IP65) was evaluated with cutting and cooling oils in general use, and it may not be resistant to special types of oil. When using other oils, be sure to contact your OMRON representative.

**ALL DIMENSIONS SHOWN ARE IN MILLIMETRES.**

To convert millimetres into inches, multiply by 0.03937. To convert grams into ounces, multiply by 0.03527.

Cat. No. C-A3GE-001 In the interest of product improvement, specifications are subject to change without notice.

# OMRON

LEADERS IN ELECTRONIC COMPONENTS

**OMRON Electronics Ltd.**

1, Apsley Way,  
Staples Corner,  
London NW2 7HF  
Phone: (081) 450 4646 Fax: (081) 450 8087