



# Low Voltage, High Accuracy, Quad Voltage $\mu$ P Supervisory Circuit

Preliminary Technical Data

**ADM6710**

## FEATURES

- Accurate monitoring of up to four power supply voltages
- 5 reset threshold options: 1.8 V to 5 V
- Monitors down to 0.62 V (1.5% accuracy)
- 200 ms typical reset timeout
- Open-drain RESET output (10  $\mu$ A internal pull-up)
- Reset output stage: active low, valid to  $IN_1 = 1$  V or  $IN_2 = 1$  V
- Low power consumption (35  $\mu$ A)
- Power supply glitch immunity
- Specified from  $-40^\circ$  C to  $+85^\circ$  C
- 6-lead SOT-23 package

## APPLICATIONS

- Microprocessor systems
- Desktop and notebook computers
- Controllers
- Data storage equipment
- Servers/workstations

## GENERAL DESCRIPTION

The ADM6710 is a low voltage, high accuracy supervisory circuit. This device monitors up to four system supply voltages.

If a monitored power supply voltage falls below the minimum voltage threshold, a single active low output asserts, triggering a system reset. The output is open drain with a weak internal pull-up to the monitored  $IN_2$  supply (or to  $V_{CC}$  in the case of the ADM67109Q) of typically 10  $\mu$ A. Once all voltages rise above the selected threshold level, the reset signal remains low for the reset timeout period (200 ms typical).

## FUNCTIONAL BLOCK DIAGRAM

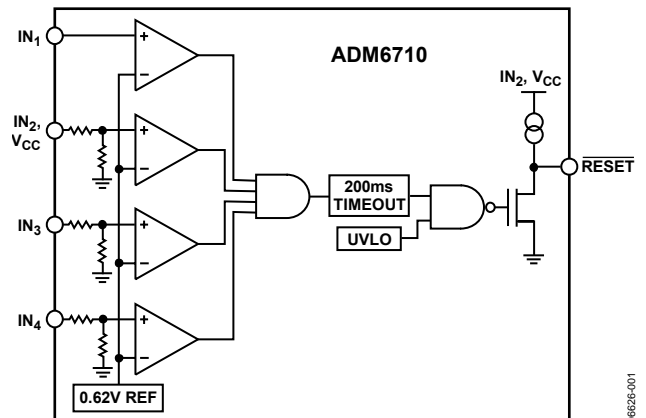

Figure 1.

06625F-001

The ADM6710 output remains valid as long as  $IN_1$  or  $IN_2$  exceeds 1V, while for the ADM6710Q the output remains valid as long as  $V_{CC}$  exceeds 2 V.

The ADM6710 incorporates a variety of internally pretrimmed undervoltage threshold options for monitoring 5.0 V, 3.3 V, 3.0 V, 2.5 V and 1.8 V supply voltages. The device offers up to three adjustable thresholds for monitoring voltages down to 0.62 V.

The ADM6710 is available in a 6-lead SOT-23 package and is suitable for use in a variety of voltage monitoring applications.

### Rev. PrB

Information furnished by Analog Devices is believed to be accurate and reliable. However, no responsibility is assumed by Analog Devices for its use, nor for any infringements of patents or other rights of third parties that may result from its use. Specifications subject to change without notice. No license is granted by implication or otherwise under any patent or patent rights of Analog Devices. Trademarks and registered trademarks are the property of their respective owners.

One Technology Way, P.O. Box 9106, Norwood, MA 02062-9106, U.S.A.  
Tel: 781.329.4700 [www.analog.com](http://www.analog.com)  
Fax: 781.461.3113 ©2007 Analog Devices, Inc. All rights reserved.

**TABLE OF CONTENTS**

Features .....	1	Theory of Operation .....	6
Applications.....	1	Input Configuration.....	6
Functional Block Diagram .....	1	Reset Output Configuration .....	6
General Description .....	1	Addition Of Manual Reset .....	7
Specifications.....	3	Outline Dimensions .....	8
Absolute Maximum ratings.....	4	Ordering Guide .....	8
ESD Caution.....	4		
Pin Configuration and Function Descriptions.....	5		

## SPECIFICATIONS

$V_{IN2} = 1\text{ V to }5.5\text{ V}$ ,  $T_A = -40^\circ\text{C to }85^\circ\text{C}$ , unless otherwise stated. Typical values are  $V_{IN2} = 3.0\text{ V to }3.3\text{ V}$ ,  $T_A = +25^\circ\text{C}$ .

Table 1.

Parameter	Min	Typ	Max	Units	Test Conditions
$V_{CC}$ OPERATING VOLTAGE RANGE <sup>1</sup>	2.0		5.5	V	ADM6710Q only
$V_{IN2}$ OPERATING VOLTAGE RANGE <sup>2</sup>	1.0		5.5	V	All devices except ADM6710Q; $T_A = 0^\circ\text{C to }+85^\circ\text{C}$
	1.2		5.5	V	All devices except ADM6710Q; $T_A = -40^\circ\text{C to }+85^\circ\text{C}$
$I_{N_x}$ INPUT CURRENT		25	40	$\mu\text{A}$	$I_{N_x} =$ nominal input voltage (for 1.8 V, 2.5 V and 5.0 V supplies)
		55	115	$\mu\text{A}$	$I_{N_2} =$ nominal input voltage (for 3.0 V and 3.3 V supplies). The supply splits into 25 $\mu\text{A}$ for the resistor divider and 30 $\mu\text{A}$ for other circuits.
			0.4	$\mu\text{A}$	$V_{IN1} = 0$ to 0.85 V (for adjustable thresholds)
			0.2	$\mu\text{A}$	$V_{IN3}, V_{IN4} = 0$ to .85 V (for adjustable thresholds)
$I_{CC}$ INPUT CURRENT		35	50		ADM6710Q only; $V_{CC} = 5.5\text{ V}$
THRESHOLD VOLTAGE ( $V_{TH}$ )	4.50	4.63	4.75	V	$I_{N_x}$ decreasing; 5 V (–5%)
	4.25	4.38	4.50	V	$I_{N_x}$ decreasing; 5 V (–10%)
	3.00	3.08	3.15	V	$I_{N_x}$ decreasing; 3.3 V (–5%)
	2.85	2.93	3.00	V	$I_{N_x}$ decreasing; 3.3 V (–10%)
	2.70	2.78	2.85	V	$I_{N_x}$ decreasing; 3.0 V (–5%)
	2.55	2.63	2.70	V	$I_{N_x}$ decreasing; 3.0 V (–10%)
	2.25	2.32	2.38	V	$I_{N_x}$ decreasing; 2.5 V (–5%)
	2.13	2.19	2.25	V	$I_{N_x}$ decreasing; 2.5 V (–10%)
	1.62	1.67	1.71	V	$I_{N_x}$ decreasing; 1.8 V (–5%)
1.53	1.58	1.62	V	$I_{N_x}$ decreasing; 1.8 V (–10%)	
ADJUSTABLE THRESHOLD ( $V_{TH}$ )	0.611	0.620	0.629	V	$I_{N_x}$ decreasing
RESET THRESHOLD HYSTERESIS ( $V_{HYST}$ )		0.3		$\%V_{TH}$	$I_{N_x}$ increasing relative to $I_{N_x}$ decreasing
RESET THRESHOLD TEMPERATURE COEFFICIENT ( $TCV_{TH}$ )		60		ppm/ $^\circ\text{C}$	
$I_{N_x}$ to RESET DELAY ( $t_{RP}$ )		30		$\mu\text{s}$	$V_{IN}$ falling at 10 mV/ $\mu\text{s}$ from $V_{TH}$ to $V_{TH} - 50\text{ mV}$
RESET TIMEOUT PERIOD ( $t_{RP}$ )	140	200	280	ms	
RESET OUTPUT LOW ( $V_{OL}$ )			0.3	V	$V_{IN2}, V_{CC} = 5\text{ V}, I_{SINK} = 2\text{ mA}$
			0.4	V	$V_{IN2}, V_{CC} = 2.5\text{ V}, I_{SINK} = 1.2\text{ mA}$
			0.3	V	$V_{IN2} = 1.0, I_{SINK} = 50\text{ }\mu\text{A}, T_A = 0^\circ\text{C to }+85^\circ\text{C}$
RESET OUTPUT HIGH ( $V_{OH}$ )	$0.8 \times V_{CC}$			V	$V_{CC} \geq 2.0\text{ V}, I_{SOURCE} = 6\text{ }\mu\text{A}, \overline{\text{RESET}}$ deasserted (ADM6710Q only)
	$0.8 \times V_{CC}$			V	$V_{IN2} \geq 2.0\text{ V}, I_{SOURCE} = 6\text{ }\mu\text{A}, \overline{\text{RESET}}$ deasserted
RESET OUTPUT HIGH SOURCE CURRENT ( $I_{OH}$ )		10		$\mu\text{A}$	$V_{IN2} \geq 2.0\text{ V}, \overline{\text{RESET}}$ deasserted

<sup>1</sup> Note that the ADM6710Q is powered from  $V_{CC}$ .

<sup>2</sup> The RESET output is guaranteed to be in the correct state for  $I_{N_1}$  or  $I_{N_2}$  down to 1 V.

## ABSOLUTE MAXIMUM RATINGS

Table 2.

Parameter	Rating
$V_{CC}$ , $I_{N_x}$ , $\overline{\text{RESET}}$ to GND	-0.3 V to +6 V
Continuous $\overline{\text{RESET}}$ Current	20 mA
Continuous Power Dissipation	450 mW
Storage Temperature Range	-65°C to +125°C
Operating Temperature Range	-40°C to +85°C
Lead Temperature (10 sec)	300°C
Junction Temperature	150°C

Stresses above those listed under Absolute Maximum Ratings may cause permanent damage to the device. This is a stress rating only and functional operation of the device at these or any other conditions above those indicated in the operational section of this specification is not implied. Exposure to absolute maximum rating conditions for extended periods may affect device reliability.

### ESD CAUTION



**ESD (electrostatic discharge) sensitive device.** Charged devices and circuit boards can discharge without detection. Although this product features patented or proprietary protection circuitry, damage may occur on devices subjected to high energy ESD. Therefore, proper ESD precautions should be taken to avoid performance degradation or loss of functionality.

## PIN CONFIGURATION AND FUNCTION DESCRIPTIONS

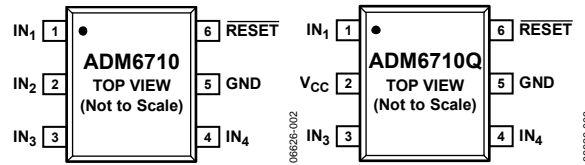

Figure 2.

Table 3. Pin Function Descriptions

Pin No.	Mnemonic	Description
1	IN <sub>1</sub>	Input Voltage 1.
2	IN <sub>2</sub>	Input Voltage 2. IN <sub>2</sub> is the power supply input for the ADM6710.
	V <sub>CC</sub>	V <sub>CC</sub> is the power supply input for the ADM6710Q. It is not a monitored input.
3	IN <sub>3</sub>	Input Voltage 3.
4	IN <sub>4</sub>	Input Voltage 4.
5	GND	Ground.
6	$\overline{\text{RESET}}$	$\overline{\text{RESET}}$ goes low when an input drops below the specified threshold. Once all inputs rise above the threshold voltage, $\overline{\text{RESET}}$ remains low for 200 ms (typical) before going high. The $\overline{\text{RESET}}$ output is open drain with a weak internal pull-up to IN <sub>2</sub> or, in the case of the ADM6710Q to V <sub>CC</sub> , typically 10 $\mu$ A.

## THEORY OF OPERATION

The ADM6710 is a compact, low power supervisory circuit capable of monitoring up to four voltages in multivoltage applications. If a monitored power supply voltage falls below the minimum voltage threshold, a single active low output asserts, triggering a system reset.

The ADM6710 includes several voltage threshold options for monitoring 5.0 V, 3.3 V, 3.0 V, 2.5 V and 1.8 V supplies. It also provides up to three adjustable thresholds for monitoring voltages down to 0.62 V. See the Ordering Guide section for a list and description of all options available.

The ADM6710 includes precision comparators, an accurate band gap reference, and a series of internally-trimmed resistor divider networks to set the factory-fixed reset threshold options. The resistor networks scale the specified INx reset voltages to match the internal band gap reference/comparator voltage.

Adjustable threshold options bypass the internal resistor networks and connect directly to one of the comparator inputs. External resistor divider networks must be used to scale voltages down for monitoring at the adjustable inputs. The ADM6710Q provides a separate unmonitored power supply input (V<sub>CC</sub>) and three adjustable voltage inputs.

The internal comparators each typically have a hysteresis of 0.3% with respect to its reset threshold. This built-in hysteresis improves the device's immunity to ambient noise without noticeably reducing the threshold accuracy. The ADM6710 is unaffected by short input transients.

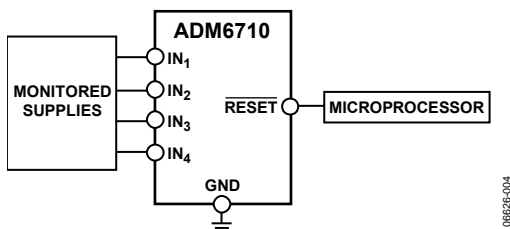

Figure 3. Typical Applications Circuit

## INPUT CONFIGURATION

The ADM6710 provides numerous monitor choices with adjustable reset thresholds. Typically, the threshold voltage at each adjustable INx input is 0.62 V. To monitor a voltage greater than 0.62 V, connect a resistor divider network to the circuit as depicted in Figure 4, where

$$V_{INTH} = 0.62 V \left( \frac{R_1 + R_2}{R_2} \right)$$

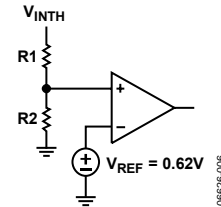

Figure 4. Setting the Adjustable Monitor

The ADM6710Q contains an internal voltage clamp at each of the adjustable voltage inputs. Input voltages greater than 1.5 V induce a higher input current.

The ADM6710 is normally powered from the monitored IN<sub>2</sub>, or V<sub>CC</sub> in the case of the ADM6710Q. Monitored inputs are resistant to short power supply glitches. To increase noise immunity in noisy applications, place a 0.1 μF capacitor between the IN<sub>2</sub> input and ground. Adding capacitance to IN<sub>1</sub>, IN<sub>3</sub>, and IN<sub>4</sub> also improves noise immunity.

Do not allow unused monitor inputs to float or to be grounded. Connect these inputs to a supply voltage greater than their specified threshold voltages. In the case of unused INx adjustable inputs, limit the bias current by connecting a 1 MΩ series resistor between the unused input and IN<sub>2</sub> (or V<sub>CC</sub> with the ADM6710Q).

## RESET OUTPUT CONFIGURATION

The ADM6710 has a reset timeout period of 200 ms (typical). The output is open drain with a weak internal pull-up to the monitored IN<sub>2</sub> or V<sub>CC</sub> supply, typically 10 μA.

In many applications that interface with other logic devices, there is no requirement for an external pull-up resistor. An external pull-up resistor to any voltage, ranging from 0 V to 5.5 V, can overdrive the internal pull-up when interfacing to different logic supply voltages (see Figure 5). Reverse current flow from the external pull-up voltage to IN<sub>2</sub> is prevented by the internal circuitry.

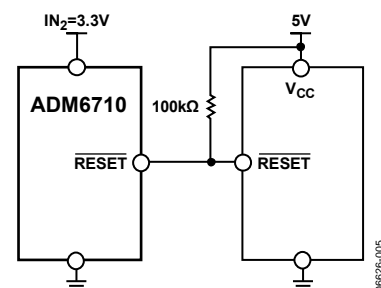

Figure 5. Interface with a Different Logic Supply Voltage

The ADM6710Q is powered by V<sub>CC</sub>, which is not a monitored voltage. All other ADM6710 options are powered by IN<sub>2</sub>, which is a monitored voltage. If a supply voltage drops below its associated threshold, the reset output asserts low and remains low while either IN<sub>1</sub> or IN<sub>2</sub> remains above 1.0 V.

**ADDITION OF MANUAL RESET**

Figure 6. Addition of Manual Reset ( $IN_4$  is an Adjustable Input).

Use the circuit shown in Figure 6 to add a manual reset to the ADM6710. When the  $\overline{\text{RESET}}$  switch is closed, the analog input shorts to ground and a  $\overline{\text{RESET}}$  output commences. The  $\overline{\text{RESET}}$  switch must remain open for a minimum of 140 ms for the  $\overline{\text{RESET}}$  output to deassert.

OUTLINE DIMENSIONS

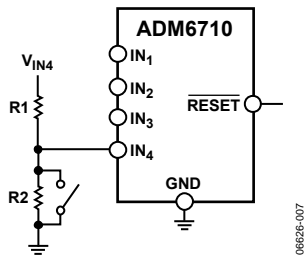
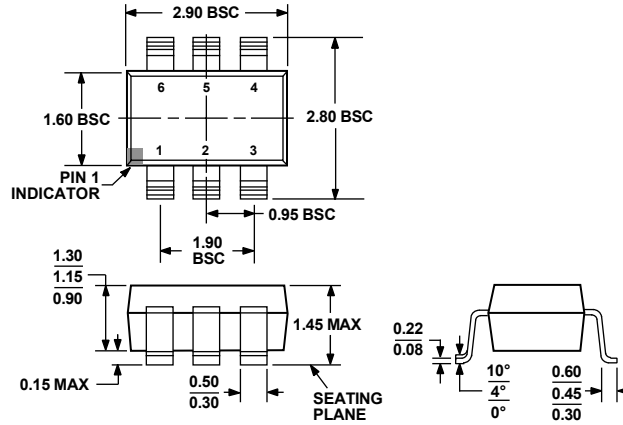

COMPLIANT TO JEDEC STANDARDS MO-178-AB

Figure 7. 6-Lead Small Outline Transistor Package [SOT-23] (RJ-6)

Dimensions shown in millimeters

ORDERING GUIDE

Model	Nominal Input Voltage				Supply Tolerance (%)	Temperature Range	Package Description	Package Option	Branding
	IN1	IN2	IN3	IN4					
ADM6710AARJZ-REEL7 <sup>1</sup>	5	3.3	2.5	Adj. <sup>2</sup>	10	-40°C to +85°C	6-Lead SOT-23	RJ-6	MA9
ADM6710BARJZ-REEL7 <sup>1</sup>	5	3.3	2.5	Adj. <sup>2</sup>	5	-40°C to +85°C	6-Lead SOT-23	RJ-6	MAH
ADM6710CARJZ-REEL7 <sup>1</sup>	5	3.3	1.8	Adj. <sup>2</sup>	10	-40°C to +85°C	6-Lead SOT-23	RJ-6	MAJ
ADM6710DARJZ-REEL7 <sup>1</sup>	5	3.3	1.8	Adj. <sup>2</sup>	5	-40°C to +85°C	6-Lead SOT-23	RJ-6	MAK
ADM6710EARJZ-REEL7 <sup>1</sup>	Adj. <sup>2</sup>	3.3	2.5	1.8	10	-40°C to +85°C	6-Lead SOT-23	RJ-6	MAX
ADM6710FARJZ-REEL7 <sup>1</sup>	Adj. <sup>2</sup>	3.3	2.5	1.8	5	-40°C to +85°C	6-Lead SOT-23	RJ-6	MA4
ADM6710GARJZ-REEL7 <sup>1</sup>	5	3.3	Adj. <sup>2</sup>	Adj. <sup>2</sup>	10	-40°C to +85°C	6-Lead SOT-23	RJ-6	MAL
ADM6710HARJZ-REEL7 <sup>1</sup>	5	3.3	Adj. <sup>2</sup>	Adj. <sup>2</sup>	5	-40°C to +85°C	6-Lead SOT-23	RJ-6	MAM
ADM6710IARJZ-REEL7 <sup>1</sup>	Adj. <sup>2</sup>	3.3	2.5	Adj. <sup>2</sup>	10	-40°C to +85°C	6-Lead SOT-23	RJ-6	MAN
ADM6710JARJZ-REEL7 <sup>1</sup>	Adj. <sup>2</sup>	3.3	2.5	Adj. <sup>2</sup>	5	-40°C to +85°C	6-Lead SOT-23	RJ-6	MAP
ADM6710KARJZ-REEL7 <sup>1</sup>	Adj. <sup>2</sup>	3.3	1.8	Adj. <sup>2</sup>	10	-40°C to +85°C	6-Lead SOT-23	RJ-6	MAQ
ADM6710LARJZ-REEL7 <sup>1</sup>	Adj. <sup>2</sup>	3.3	1.8	Adj. <sup>2</sup>	5	-40°C to +85°C	6-Lead SOT-23	RJ-6	MAR
ADM6710MARJZ-REEL7 <sup>1</sup>	Adj. <sup>2</sup>	3	2.5	Adj. <sup>2</sup>	10	-40°C to +85°C	6-Lead SOT-23	RJ-6	MAS
ADM6710NARJZ-REEL7 <sup>1</sup>	Adj. <sup>2</sup>	3	2.5	Adj. <sup>2</sup>	5	-40°C to +85°C	6-Lead SOT-23	RJ-6	MAT
ADM6710OARJZ-REEL7 <sup>1</sup>	Adj. <sup>2</sup>	3	1.8	Adj. <sup>2</sup>	10	-40°C to +85°C	6-Lead SOT-23	RJ-6	MAU
ADM6710PARJZ-REEL7 <sup>1</sup>	Adj. <sup>2</sup>	3	1.8	Adj. <sup>2</sup>	5	-40°C to +85°C	6-Lead SOT-23	RJ-6	MAV
ADM6710QARJZ-REEL7 <sup>1</sup>	Adj. <sup>2</sup>	V <sub>CC</sub>	Adj. <sup>2</sup>	Adj. <sup>2</sup>	N/A	-40°C to +85°C	6-Lead SOT-23	RJ-6	MAW

<sup>1</sup> Z = RoHS Compliant Part.

<sup>2</sup> Adjustable voltage based on 0.62 V internal threshold. The external threshold voltage can be set using an external resistor divider.