

384/402-OUTPUT TFT-LCD SOURCE DRIVER (COMPATIBLE WITH 64-GRAY SCALES)

DESCRIPTION

The μ PD160903 is a source driver for TFT-LCDs capable of dealing with displays with 64-gray scales. Data input is based on digital input configured as 6 bits by 6 dots (2 pixels), which can realize a full-color display of 262,144 colors by output of 64 values γ -corrected by an internal D/A converter and 5-by-2 external power modules. Because the output dynamic range is as large as $V_{SS2} + 0.1$ V to $V_{DD2} - 0.1$ V, level inversion operation of the LCD's common electrode is rendered unnecessary. Also, to be able to deal with dot-line inversion, n-line inversion and column line inversion when mounted on a single side, this source driver is equipped with a built-in 6-bit D/A converter circuit whose odd output pins and even output pins respectively output gray scale voltages of differing polarity. Assuring a clock frequency of 45 MHz when driving at 2.7 V.

FEATURES

- CMOS level input
- 384/402 outputs
- Input of 6 bits (gray-scale data) by 6 dots
- Capable of outputting 64 values by means of 5-by-2 external power modules (10 units) and a D/A converter
- Logic power supply voltage (V_{DD1}): 2.7 to 3.6 V
- Driver power supply voltage (V_{DD2}): 5.5 V \pm 0.275 V
- High-speed data transfer: $f_{CLK} = 45$ MHz (internal data transfer speed when operating at $V_{DD1} = 2.7$ V)
- Output dynamic range: $V_{SS2} + 0.1$ V to $V_{DD2} - 0.1$ V
- Apply for dot-line inversion, n-line inversion and column line inversion
- Output voltage polarity inversion function (POL)
- Display data inversion function (POL21, POL22)
- Single-side mounting is possible (incorporation of slim TCP)

ORDERING INFORMATION

Part Number	Package
μ PD160903N-xxx	TCP (TAB package)

Remark The TCP's external shape is customized. To order the required shape, so please contact one of our sales representatives.

The information in this document is subject to change without notice. Before using this document, please confirm that this is the latest version.
Not all devices/types available in every country. Please check with local NEC representative for availability and additional information.

1. BLOCK DIAGRAM

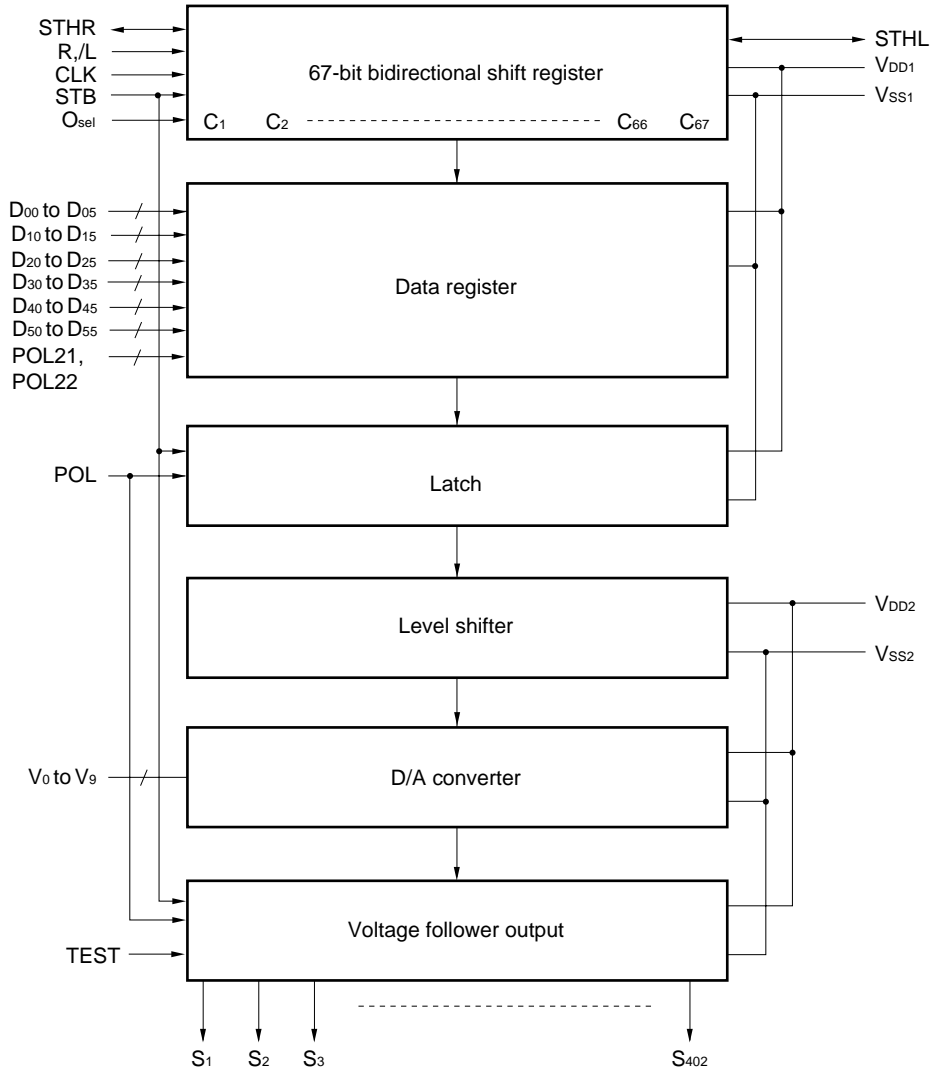

Remark /xxx indicates active low signal.

2. RELATIONSHIP BETWEEN OUTPUT CIRCUIT AND D/A CONVERTER

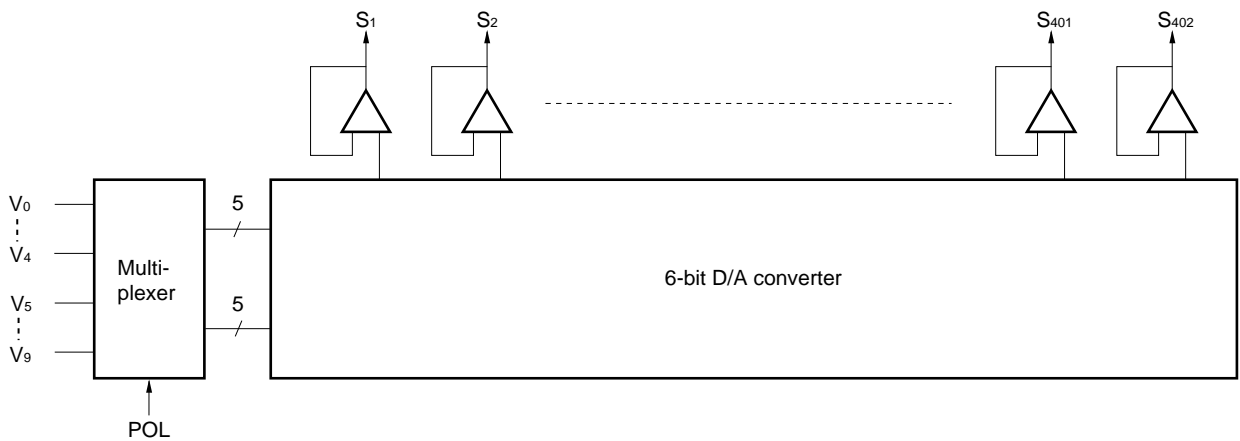

3. PIN CONFIGURATION (μPD160903N-xxx) (Copper Foil Surface, Face-up)

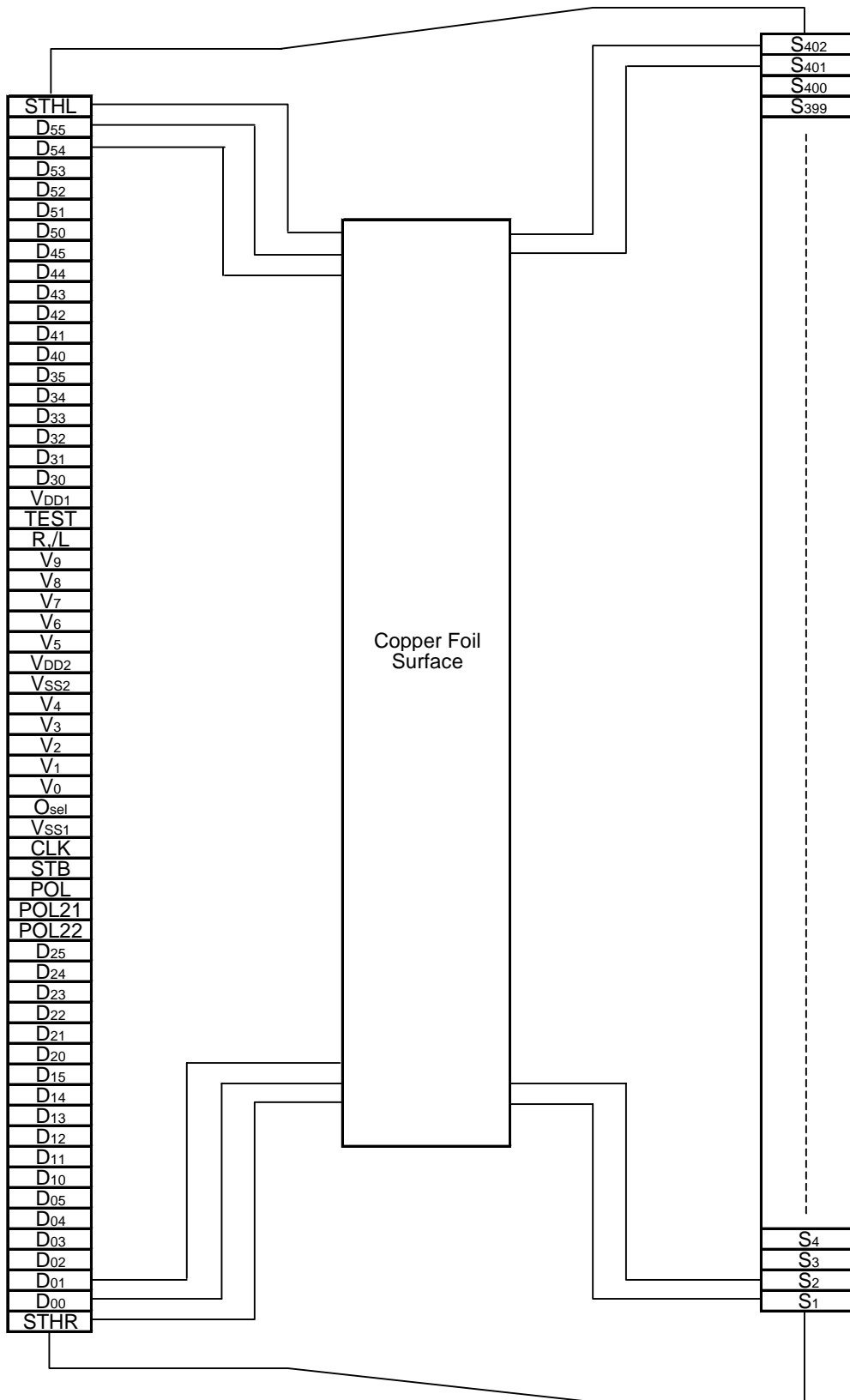

Remark This figure does not specify the TCP package.

4. PIN FUNCTIONS

(1/2)

Pin Symbol	Pin Name	I/O	Description
S ₁ to S ₄₀₂	Driver output	O	The D/A converted 64-gray-scale analog voltage is output.
O _{sel}	Selection number of outputs switching	I	O _{sel} : = H or open: 384 outputs (Output pins S ₁₉₃ through S ₂₁₀ are invalid) O _{sel} : = L: 402 outputs Pulled up internally in the LSI.
D ₀₀ to D ₀₅	Display data	I	The display data is input with a width of 36 bits, viz., the gray scale data (6 bits) by 6 dots (2 pixels). D _{x0} : LSB, D _{x5} : MSB
D ₁₀ to D ₁₅			
D ₂₀ to D ₂₅			
D ₃₀ to D ₃₅			
D ₄₀ to D ₄₅			
D ₅₀ to D ₅₅			
R,/L	Shift direction control	I	Refers to the shift direction control. The shift directions of the shift registers are as follows. R,/L = H (right shift): STHR (input), S ₁ → S ₄₀₂ , STHL (output) R,/L = L (left shift) : STHL (input), S ₄₀₂ → S ₁ , STHR (output)
STHR	Right shift start pulse	I/O	These refer to the start pulse I/O pins when driver ICs are connected in cascade. Fetching of display data starts when H is read at the rising edge of CLK. R,/L = H (right shift): STHR input, STHL output R,/L = L (left shift): STHL input, STHR output A high level should be input as the pulse of one cycle of the clock signal. If the start pulse input is more than 2CLK, the first 1CLK of the high-level input is valid.
STHL	Left shift start pulse	I/O	
CLK	Shift clock	I	Refers to the shift register's shift clock input. The display data is incorporated into the data register at the rising edge. At the rising edge of the 67th clock (64th clock in 384 outputs mode) after the start pulse input, the start pulse output reaches the high level, thus becoming the start pulse of the next-level driver. If 69th clock (66th clock in 384 mode) pulses are input after input of the start pulse, input of display data is halted automatically. The contents of the shift register are cleared at the STB's rising edge.
STB	Latch	Input	The contents of the data register are transferred to the latch circuit at the rising edge. And, at the falling edge, the gray scale voltage is supplied to the driver after 4CLK. It is necessary to ensure input of one pulse per horizontal period.
POL	Polarity	I	POL = L: The S _{2n-1} output uses V ₀ to V ₄ as the reference supply. The S _{2n} output uses V ₅ to V ₉ as the reference supply. POL = H: The S _{2n-1} output uses V ₅ to V ₉ as the reference supply. The S _{2n} output uses V ₀ to V ₄ as the reference supply. S _{2n-1} indicates the odd output: and S _{2n} indicates the even output. Input of the POL signal is allowed the setup time (t _{POL-STB}) with respect to STB's rising edge.
★ POL21, POL22	Data inversion	I	Data inversion can invert when display data is loaded. POL21: Invert/not invert of display data D ₀₀ to D ₀₅ , D ₁₀ to D ₁₅ , D ₂₀ to D ₂₅ . POL22: Invert/not invert of display data D ₃₀ to D ₃₅ , D ₄₀ to D ₄₅ , D ₅₀ to D ₅₅ . POL21, POL22 = H : Display data is inverted. POL21, POL22 = L : Display data is not inverted.
TEST	Test	I	Normally, TEST = H or open. This pin is pulled up to the V _{DD1} power supply inside the IC
V ₀ to V ₉	γ-corrected power supplies	-	Input the γ-corrected power supplies from outside by using operational amplifier. Make sure to maintain the following relationships. During the gray scale voltage output, be sure to keep the gray scale level power supply at a constant level. V _{DD2} - 0.1 V ≥ V ₀ > V ₁ > V ₂ > V ₃ > V ₄ > 0.5 V _{DD2} > V ₅ > V ₆ > V ₇ > V ₈ > V ₉ ≥ V _{SS2} + 0.1 V

(2/2)

Pin Symbol	Pin Name	I/O	Description
V _{DD1}	Logic power supply	–	2.7 to 3.6 V
V _{DD2}	Driver power supply	–	5.5 V ± 0.275 V
V _{SS1}	Logic ground	–	Grounding
V _{SS2}	Driver ground	–	Grounding

Cautions 1. The power start sequence must be V_{DD1}, logic input, and V_{DD2} & V₀ to V₉ in that order. Reverse this sequence to shut.

2. To stabilize the supply voltage, please be sure to insert a 0.1 μF bypass capacitor between V_{DD1}-V_{SS1} and V_{DD2}-V_{SS2}. Furthermore, for increased precision of the D/A converter, insertion of a bypass capacitor of about 0.01 μF is also recommended between the γ-corrected power supply terminals (V₀, V₁, V₂,....., V₉) and V_{SS2}.

5. RELATIONSHIP BETWEEN INPUT DATA AND OUTPUT VOLTAGE VALUE

The μ PD160903 incorporates a 6-bit D/A converter whose odd output pins and even output pins output respectively gray scale voltages of differing polarity with respect to the LCD's counter electrode voltage. The D/A converter consists of ladder resistors and switches.

The ladder resistors (r0 to r62) are designed so that the ratio of LCD panel γ-compensated voltages to V_{0'} to V_{63'} and V_{0''} to V_{63''} is almost equivalent. For the 2 sets of five γ-compensated power supplies, V₀ to V₄ and V₅ to V₉, respectively, input gray scale voltages of the same polarity with respect to the common voltage.

Figure 5-1 shows the relationship between the driving voltages such as liquid-crystal driving voltages V_{DD2} and V_{SS2}, common electrode potential V_{COM}, and γ-corrected voltages V₀ to V₉ and the input data. Be sure to maintain the voltage relationships as follows:

$$V_{DD2} - 0.1 V \geq V_0 > V_1 > V_2 > V_3 > V_4 > 0.5 V_{DD2} > V_5 > V_6 > V_7 > V_8 > V_9 \geq V_{SS2} + 0.1 V$$

Figures 5-2 and 5-3 indicates the relationship between the input data and output voltage and the resistance values of the resistor strings.

Figure 5-1. Relationship between Input Data and γ-corrected Power Supplies

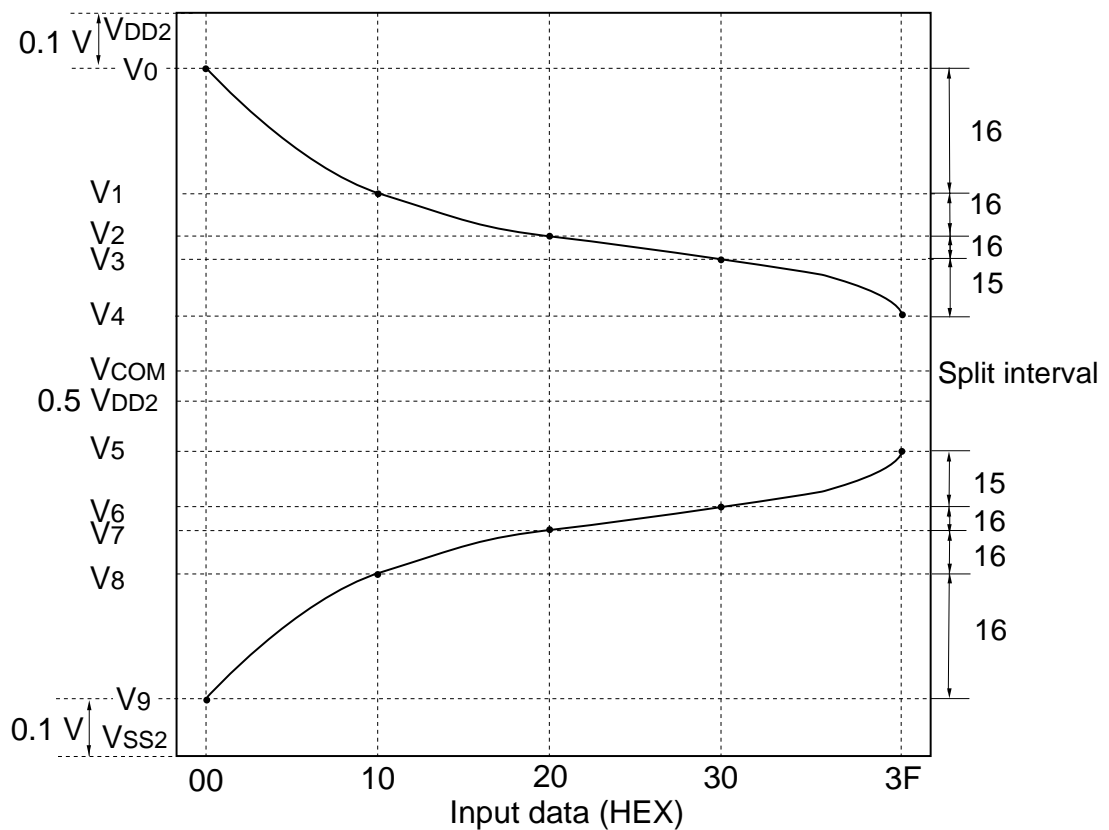
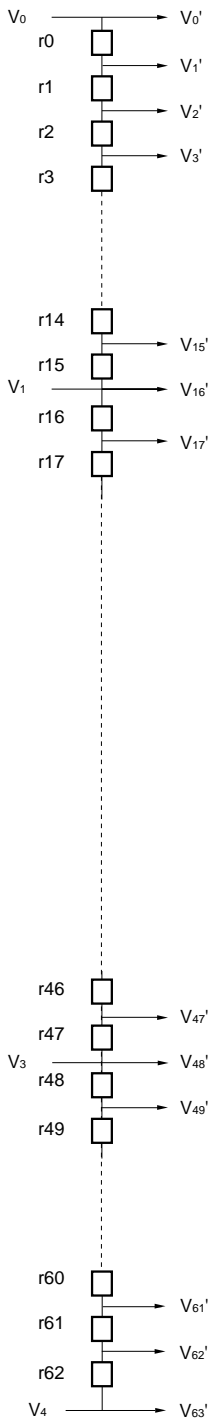

Figure 5-2. Relationship between Input Data and Output Voltage

$$V_{DD2} - 0.1 V \geq V_0 > V_1 > V_2 > V_3 > V_4 > 0.5 V_{DD2}, \text{POL21, POL22} = L$$



Data	DX5	DX4	DX3	DX2	DX1	DX0	Output voltage	
00H	0	0	0	0	0	0	V0'	V0
01H	0	0	0	0	0	1	V1'	V1+(V0-V1)x
02H	0	0	0	0	1	0	V2'	V1+(V0-V1)x
03H	0	0	0	0	1	1	V3'	V1+(V0-V1)x
04H	0	0	0	1	0	0	V4'	V1+(V0-V1)x
05H	0	0	0	1	0	1	V5'	V1+(V0-V1)x
06H	0	0	0	1	1	0	V6'	V1+(V0-V1)x
07H	0	0	0	1	1	1	V7'	V1+(V0-V1)x
08H	0	0	1	0	0	0	V8'	V1+(V0-V1)x
09H	0	0	1	0	0	1	V9'	V1+(V0-V1)x
0AH	0	0	1	0	1	0	V10'	V1+(V0-V1)x
0BH	0	0	1	0	1	1	V11'	V1+(V0-V1)x
0CH	0	0	1	1	0	0	V12'	V1+(V0-V1)x
0DH	0	0	1	1	0	1	V13'	V1+(V0-V1)x
0EH	0	0	1	1	1	0	V14'	V1+(V0-V1)x
0FH	0	0	1	1	1	1	V15'	V1+(V0-V1)x
10H	0	1	0	0	0	0	V16'	V1
11H	0	1	0	0	0	1	V17	V2+(V1-V2)x
12H	0	1	0	0	1	0	V18'	V2+(V1-V2)x
13H	0	1	0	0	1	1	V19'	V2+(V1-V2)x
14H	0	1	0	1	0	0	V20'	V2+(V1-V2)x
15H	0	1	0	1	0	1	V21'	V2+(V1-V2)x
16H	0	1	0	1	1	0	V22'	V2+(V1-V2)x
17H	0	1	0	1	1	1	V23'	V2+(V1-V2)x
18H	0	1	1	0	0	0	V24'	V2+(V1-V2)x
19H	0	1	1	0	0	1	V25'	V2+(V1-V2)x
1AH	0	1	1	0	1	0	V26'	V2+(V1-V2)x
1BH	0	1	1	0	1	1	V27'	V2+(V1-V2)x
1CH	0	1	1	1	0	0	V28'	V2+(V1-V2)x
1DH	0	1	1	1	0	1	V29'	V2+(V1-V2)x
1EH	0	1	1	1	1	0	V30'	V2+(V1-V2)x
1FH	0	1	1	1	1	1	V31'	V2+(V1-V2)x
20H	1	0	0	0	0	0	V32'	V2
21H	1	0	0	0	0	1	V33'	V3+(V2-V3)x
22H	1	0	0	0	1	0	V34'	V3+(V2-V3)x
23H	1	0	0	0	1	1	V35'	V3+(V2-V3)x
24H	1	0	0	1	0	0	V36'	V3+(V2-V3)x
25H	1	0	0	1	0	1	V37'	V3+(V2-V3)x
26H	1	0	0	1	1	0	V38'	V3+(V2-V3)x
27H	1	0	0	1	1	1	V39'	V3+(V2-V3)x
28H	1	0	1	0	0	0	V40'	V3+(V2-V3)x
29H	1	0	1	0	0	1	V41'	V3+(V2-V3)x
2AH	1	0	1	0	1	0	V42'	V3+(V2-V3)x
2BH	1	0	1	0	1	1	V43'	V3+(V2-V3)x
2CH	1	0	1	1	0	0	V44'	V3+(V2-V3)x
2DH	1	0	1	1	0	1	V45'	V3+(V2-V3)x
2EH	1	0	1	1	1	0	V46'	V3+(V2-V3)x
2FH	1	0	1	1	1	1	V47'	V3+(V2-V3)x
30H	1	1	0	0	0	0	V48'	V3
31H	1	1	0	0	0	1	V49'	V4+(V3-V4)x
32H	1	1	0	0	1	0	V50'	V4+(V3-V4)x
33H	1	1	0	0	1	1	V51'	V4+(V3-V4)x
34H	1	1	0	1	0	0	V52'	V4+(V3-V4)x
35H	1	1	0	1	0	1	V53'	V4+(V3-V4)x
36H	1	1	0	1	1	0	V54'	V4+(V3-V4)x
37H	1	1	0	1	1	1	V55'	V4+(V3-V4)x
38H	1	1	1	0	0	0	V56'	V4+(V3-V4)x
39H	1	1	1	0	0	1	V57'	V4+(V3-V4)x
3AH	1	1	1	0	1	0	V58'	V4+(V3-V4)x
3BH	1	1	1	0	1	1	V59'	V4+(V3-V4)x
3CH	1	1	1	1	0	0	V60'	V4+(V3-V4)x
3DH	1	1	1	1	0	1	V61'	V4+(V3-V4)x
3EH	1	1	1	1	1	0	V62'	V4+(V3-V4)x
3FH	1	1	1	1	1	1	V63'	V4

rn	Resistance ratio
r0	800
r1	750
r2	700
r3	650
r4	600
r5	550
r6	550
r7	500
r8	500
r9	400
r10	400
r11	350
r12	350
r13	350
r14	300
r15	300
r16	300
r17	250
r18	250
r19	250
r20	200
r21	200
r22	200
r23	150
r24	150
r25	150
r26	150
r27	100
r28	100
r29	100
r30	100
r31	100
r32	100
r33	100
r34	100
r35	100
r36	100
r37	100
r38	100
r39	100
r40	100
r41	100
r42	100
r43	100
r44	100
r45	100
r46	100
r47	100
r48	100
r49	100
r50	100
r51	100
r52	100
r53	150
r54	150
r55	150
r56	200
r57	200
r58	250
r59	250
r60	300
r61	500
r62	800

Caution There is no connection between V4 and V5 terminal in the chip.

6. RELATIONSHIP BETWEEN INPUT DATA AND OUTPUT PIN

Data format : 6 bits x 2 RGBs (6 dots)

Input width : 36 bits (2-pixel data)

(1) R,/L = H (Right shift)

Output	S ₁	S ₂	S ₃	S ₄	...	S ₄₀₁	S ₄₀₂
Data	D ₀₀ to D ₀₅	D ₁₀ to D ₁₅	D ₂₀ to D ₂₅	D ₃₀ to D ₃₅	...	D ₄₀ to D ₄₅	D ₅₀ to D ₅₅

(2) R,/L = L (Left shift)

Output	S ₁	S ₂	S ₃	S ₄	...	S ₄₀₁	S ₄₀₂
Data	D ₀₀ to D ₀₅	D ₁₀ to D ₁₅	D ₂₀ to D ₂₅	D ₃₀ to D ₃₅	...	D ₄₀ to D ₄₅	D ₅₀ to D ₅₅

POL	S _{2n-1} <small>Note</small>	S _{2n} <small>Note</small>
L	V ₀ to V ₄	V ₅ to V ₉
H	V ₅ to V ₉	V ₀ to V ₄

Note S_{2n-1} (Odd output), S_{2n} (Even output), n = 1, 2, 201

7. RELATIONSHIP BETWEEN STB, POL AND OUTPUT WAVEFORM

The gray-scale voltage is output 4 clocks after the start of D/A conversion in the LSI, in synchronization with the rising edge of STB.

During this 4-clock period, Hi-Z is output.

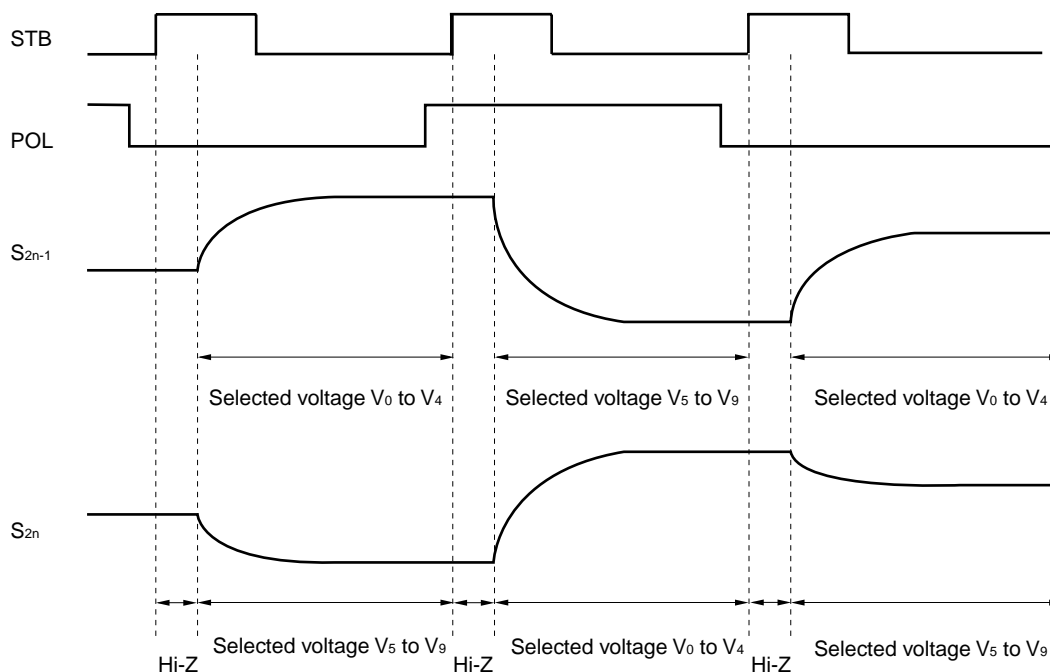

8. ELECTRICAL SPECIFICATIONS

Absolute Maximum Ratings (T_A = 25°C, V_{SS1} = V_{SS2} = 0 V)

Parameter	Symbol	Rating	Unit
Logic Part Supply Voltage	V _{DD1}	-0.5 to +4.0	V
Driver Part Supply Voltage	V _{DD2}	-0.5 to +10.0	V
Logic Part Input Voltage	V _{I1}	-0.5 to V _{DD1} + 0.5	V
Driver Part Input Voltage	V _{I2}	-0.5 to V _{DD2} + 0.5	V
Logic Part Output Voltage	V _{O1}	-0.5 to V _{DD1} + 0.5	V
Driver Part Output Voltage	V _{O2}	-0.5 to V _{DD2} + 0.5	V
Operating Ambient Temperature	T _A	-20 to +75	°C
Storage Temperature	T _{stg}	-55 to +125	°C

Caution Product quality may suffer if the absolute maximum rating is exceeded even momentarily for any parameter. That is, the absolute maximum ratings are rated values at which the product is on the verge of suffering physical damage, and therefore the product must be used under conditions that ensure that the absolute maximum ratings are not exceeded.

Recommended Operating Range (T_A = -20 to +75°C, V_{SS1} = V_{SS2} = 0 V)

Parameter	Symbol	Conditions	MIN.	TYP.	MAX.	Unit
Logic Part Supply Voltage	V _{DD1}		2.7	3.3	3.6	V
Driver Part Supply Voltage	V _{DD2}		5.225	5.5	5.775	V
High-Level Input Voltage	V _{IH}		0.7 V _{DD1}		V _{DD1}	V
Low-Level Input Voltage	V _{IL}		0		0.3 V _{DD1}	V
γ-Corrected Voltage	V ₀ to V ₄		0.5 V _{DD2}		V _{DD2} -0.1	V
	V ₅ to V ₉		0.1		0.5 V _{DD2}	V
Driver Part Output Voltage	V _O		0.1		V _{DD2} -0.1	V
Clock Frequency	f _{CLK}				45	MHz

Electrical Characteristics (T_A = -20 to +75°C, V_{DD1} = 2.7 to 3.6 V, V_{DD2} = 5.5 V ± 0.275 V, V_{SS1} = V_{SS2} = 0 V)

Parameter	Symbol	Condition	MIN.	TYP.	MAX.	Unit
Input Leak Current	I _{IL}				±1.0	μA
High-Level Output Voltage	V _{OH}	STHR (STHL), I _{OH} = 0 mA	V _{DD1} - 0.1			V
Low-Level Output Voltage	V _{OL}	STHR (STHL), I _{OL} = 0 mA			0.1	V
γ-Corrected Resistance	R _γ	V _{DD2} = 5.5 V V ₀ to V ₄ = V ₅ to V ₉ = 2.0 V	6.0	12.0	18.0	kΩ
Driver Output Current	I _{VOH}	V _{DD2} = 5.5 V, V _X = 5.0 V, V _{OUT} = 4.5 V ^{Note1}		-150	-70	μA
	I _{VOL}	V _{DD2} = 5.5 V, V _X = 0.5 V, V _{OUT} = 1.0 V ^{Note1}	70	250		μA
Output Voltage Deviation	ΔV _O	T _A = 25°C, V _{SS2} + 1.0 V to V _{DD2} - 1.0 V		±5	±20	mV
Output Swing Difference Deviation	ΔV _{P-P1}	V _{DD1} = 3.3 V V _{OUT} = 1.2 to 4.3 V		±3	±15	mV
	ΔV _{P-P2}	V _{DD2} = 5.5 V V _{OUT} = 0.8 to 4.7 V		±7	±20	mV
	ΔV _{P-P3}	T _A = 25°C V _{OUT} = 0.1 to 5.4 V		±15	±30	mV
Logic Part Dynamic Current Consumption ^{Note2,3,4}	I _{DD1}	V _{DD1}		1.0	6.0	mA
Driver Part Dynamic Current Consumption ^{Note2,4}	I _{DD2}	V _{DD2} , with no load		3.7	7.0	mA

Notes 1. V_X refers to the output voltage of analog output pins S₁ to S₄₀₂.

V_{OUT} refers to the voltage applied to analog output pins S₁ to S₄₀₂.

2. f_{STB} = 48 kHz, f_{CLK} = 32.5 MHz

3. The TYP. values refer to an all black or all white input pattern. The MAX. value refers to the measured values in the dot checkerboard input pattern.

4. Refers to the current consumption per driver when cascades are connected under the assumption of XGA single-sided mounting (8 units).

Switching Characteristics (T_A = -20 to +75°C, V_{DD1} = 2.7 to 3.6 V, V_{DD2} = 5.5 V ± 0.275 V, V_{SS1} = V_{SS2} = 0 V)

Parameter	Symbol	Condition	MIN.	TYP.	MAX.	Unit
Start Pulse Delay Time	t _{PLH1}	C _L = 15 pF		9	18	ns
Driver Output Delay Time	t _{PLH2} ^{Note}	C _L = 150 pF, R _L = 4.7 kΩ		3.8	5.0	μs
	t _{PLH3} ^{Note}			5.4	8.5	μs
	t _{PHL2} ^{Note}			3.3	5.0	μs
	t _{PHL3} ^{Note}			4.4	8.5	μs
Input Capacitance	C _{I1}	Logic input other than STHR (STHL) is T _A = 25°C		5	10	pF
	C _{I2}	STHR (STHL), T _A = 25°C		8	15	pF

Note t_{PLH2} and t_{PHL2} are the time until the voltage reached its target voltage ±10% from the falling edge of STB.

t_{PLH2} and t_{PHL2} are the time until the voltage reached its target voltage ±20 mV from the falling edge of STB.

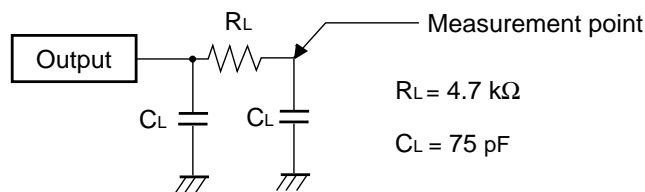

Timing Requirements ($T_A = -20$ to $+75^\circ\text{C}$, $V_{DD1} = 2.7$ to 3.6 V, $V_{SS1} = 0$ V, $t_r = t_f = 5.0$ ns)

Parameter	Symbol	Condition	MIN.	TYP.	MAX.	Unit
Clock Pulse Width	PW_{CLK}		22			ns
Clock Pulse High Period	$PW_{CLK(H)}$		4			ns
Clock Pulse Low Period	$PW_{CLK(L)}$		4			ns
Data Setup Time	t_{SETUP1}		4			ns
Data Hold Time	t_{HOLD1}		2			ns
Start Pulse Setup Time	t_{SETUP2}		4			ns
Start Pulse Hold Time	t_{HOLD2}		2			ns
POL21/22 Setup Time	t_{SETUP3}		2			ns
POL21/22 Hold Time	t_{HOLD3}		3			ns
STB Pulse Width	PW_{STB}		4			CLK
Last Data Timing	t_{LDT}		2			CLK
CLK-STB Time	$t_{CLK-STB}$	CLK \uparrow \rightarrow STB \uparrow	4			ns
STB-CLK Time	$t_{STB-CLK}$	STB \uparrow \rightarrow CLK \uparrow	4			ns
Time Between STB and Start Pulse	$t_{STB-STH}$	STB \uparrow \rightarrow STHR(STHL) \uparrow	2			CLK
POL-STB Time	$t_{POL-STB}$	POL \uparrow or \downarrow \rightarrow STB \uparrow	6			ns
STB-POL Time	$t_{STB-POL}$	STB \downarrow \rightarrow POL \downarrow or \uparrow	6			ns

Remark Unless otherwise specified, the input level is defined to be $V_{IH} = 0.7 V_{DD1}$, $V_{IL} = 0.3 V_{DD1}$.

★ Switching Characteristic Waveform(R,/L= H)

Unless otherwise specified, the input level is defined to be $V_{IH} = 0.7 V_{DD1}$, $V_{IL} = 0.3 V_{DD1}$ (the clock and display data numbers are examples when the resolution is XGA).

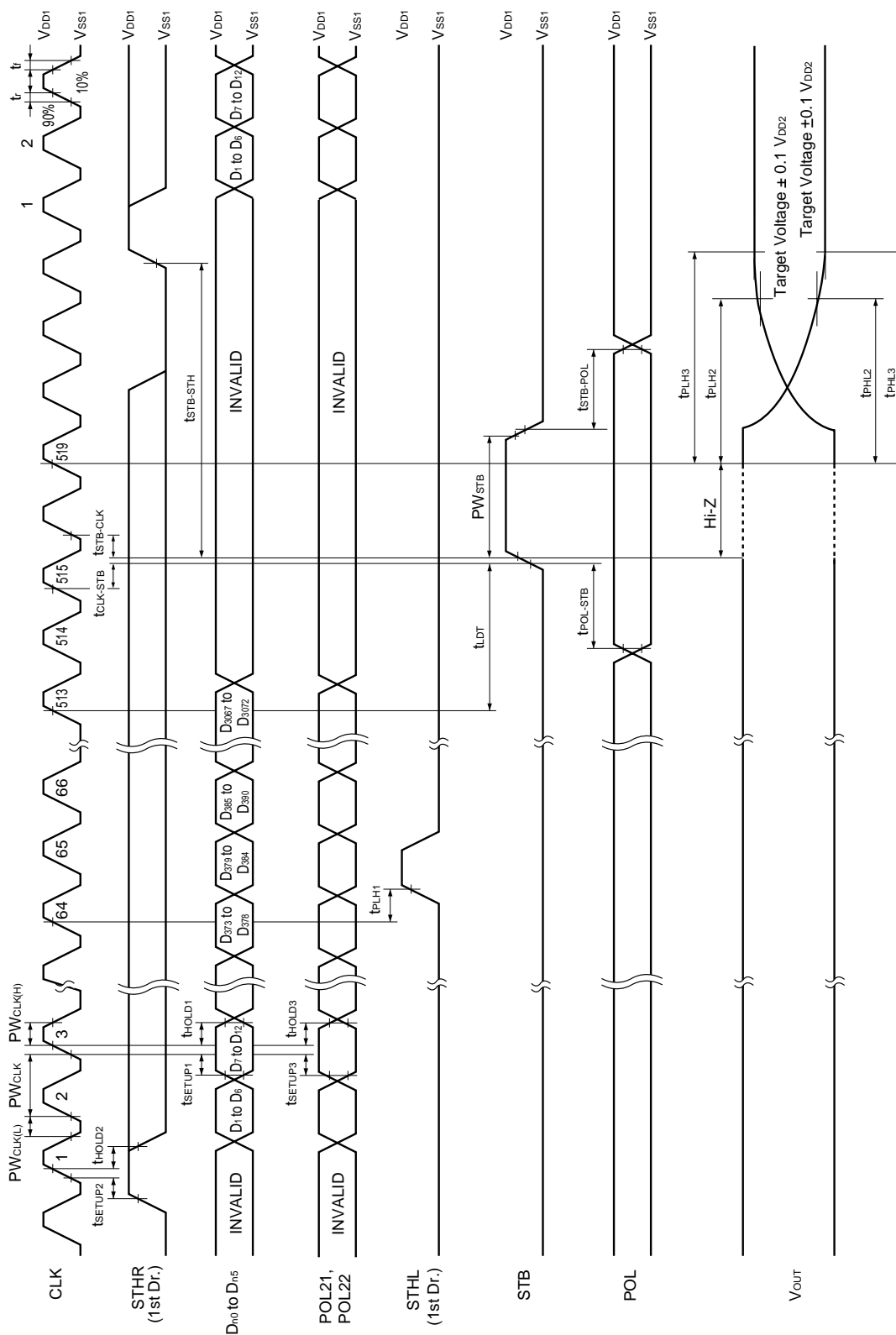

9. RECOMMENDED MOUNTING CONDITIONS

The following conditions must be met for mounting conditions of the μPD160903.

For more details, refer to the **Semiconductor Device Mounting Technology Manual (C10535E)**.

Please consult with our sales offices in case other mounting process is used, or in case the mounting is done under different conditions.

μPD160903N-xxx : TCP (TAB Package)

Mounting Condition	Mounting Method	Condition
Thermocompression	Soldering	Heating tool 300 to 350°C, heating for 2 to 3 seconds : pressure 100g (per solder)
	ACF (Adhesive Conductive Film)	Temporary bonding 70 to 100°C : pressure 3 to 8 kg/cm ² : time 3 to 5 sec. Real bonding 165 to 180°C: pressure 25 to 45 kg/cm ² : time 30 to 40 sec. (When using the anisotropy conductive film SUMIZAC1003 of Sumitomo Bakelite, Ltd).

Caution To find out the detailed conditions for mounting the ACF part, please contact the ACF manufacturing company. Be sure to avoid using two or more mounting methods at a time.

NOTES FOR CMOS DEVICES**① PRECAUTION AGAINST ESD FOR SEMICONDUCTORS**

Note:

Strong electric field, when exposed to a MOS device, can cause destruction of the gate oxide and ultimately degrade the device operation. Steps must be taken to stop generation of static electricity as much as possible, and quickly dissipate it once, when it has occurred. Environmental control must be adequate. When it is dry, humidifier should be used. It is recommended to avoid using insulators that easily build static electricity. Semiconductor devices must be stored and transported in an anti-static container, static shielding bag or conductive material. All test and measurement tools including work bench and floor should be grounded. The operator should be grounded using wrist strap. Semiconductor devices must not be touched with bare hands. Similar precautions need to be taken for PW boards with semiconductor devices on it.

② HANDLING OF UNUSED INPUT PINS FOR CMOS

Note:

No connection for CMOS device inputs can be cause of malfunction. If no connection is provided to the input pins, it is possible that an internal input level may be generated due to noise, etc., hence causing malfunction. CMOS devices behave differently than Bipolar or NMOS devices. Input levels of CMOS devices must be fixed high or low by using a pull-up or pull-down circuitry. Each unused pin should be connected to V_{DD} or GND with a resistor, if it is considered to have a possibility of being an output pin. All handling related to the unused pins must be judged device by device and related specifications governing the devices.

③ STATUS BEFORE INITIALIZATION OF MOS DEVICES

Note:

Power-on does not necessarily define initial status of MOS device. Production process of MOS does not define the initial operation status of the device. Immediately after the power source is turned ON, the devices with reset function have not yet been initialized. Hence, power-on does not guarantee out-pin levels, I/O settings or contents of registers. Device is not initialized until the reset signal is received. Reset operation must be executed immediately after power-on for devices having reset function.

Reference Documents

NEC Semiconductor Device Reliability/Quality Control System (C10983E)

Quality Grades to NEC's Semiconductor Devices (C11531E)

- **The information in this document is current as of June, 2001. The information is subject to change without notice. For actual design-in, refer to the latest publications of NEC's data sheets or data books, etc., for the most up-to-date specifications of NEC semiconductor products. Not all products and/or types are available in every country. Please check with an NEC sales representative for availability and additional information.**
 - No part of this document may be copied or reproduced in any form or by any means without prior written consent of NEC. NEC assumes no responsibility for any errors that may appear in this document.
 - NEC does not assume any liability for infringement of patents, copyrights or other intellectual property rights of third parties by or arising from the use of NEC semiconductor products listed in this document or any other liability arising from the use of such products. No license, express, implied or otherwise, is granted under any patents, copyrights or other intellectual property rights of NEC or others.
 - Descriptions of circuits, software and other related information in this document are provided for illustrative purposes in semiconductor product operation and application examples. The incorporation of these circuits, software and information in the design of customer's equipment shall be done under the full responsibility of customer. NEC assumes no responsibility for any losses incurred by customers or third parties arising from the use of these circuits, software and information.
 - While NEC endeavours to enhance the quality, reliability and safety of NEC semiconductor products, customers agree and acknowledge that the possibility of defects thereof cannot be eliminated entirely. To minimize risks of damage to property or injury (including death) to persons arising from defects in NEC semiconductor products, customers must incorporate sufficient safety measures in their design, such as redundancy, fire-containment, and anti-failure features.
 - NEC semiconductor products are classified into the following three quality grades:
 "Standard", "Special" and "Specific". The "Specific" quality grade applies only to semiconductor products developed based on a customer-designated "quality assurance program" for a specific application. The recommended applications of a semiconductor product depend on its quality grade, as indicated below. Customers must check the quality grade of each semiconductor product before using it in a particular application.
 "Standard": Computers, office equipment, communications equipment, test and measurement equipment, audio and visual equipment, home electronic appliances, machine tools, personal electronic equipment and industrial robots
 "Special": Transportation equipment (automobiles, trains, ships, etc.), traffic control systems, anti-disaster systems, anti-crime systems, safety equipment and medical equipment (not specifically designed for life support)
 "Specific": Aircraft, aerospace equipment, submersible repeaters, nuclear reactor control systems, life support systems and medical equipment for life support, etc.
- The quality grade of NEC semiconductor products is "Standard" unless otherwise expressly specified in NEC's data sheets or data books, etc. If customers wish to use NEC semiconductor products in applications not intended by NEC, they must contact an NEC sales representative in advance to determine NEC's willingness to support a given application.
- (Note)
- (1) "NEC" as used in this statement means NEC Corporation and also includes its majority-owned subsidiaries.
 - (2) "NEC semiconductor products" means any semiconductor product developed or manufactured by or for NEC (as defined above).