

LO564NHR4-B0G

Features

All Plastic Mold Type
 Elliptical Package
 High Luminous Intensity
 Tinted Diffused Lens
 Wide Viewing Angle Up To 100° x 50°

Applications

Backlighting
 VMS
 Full Color/RGB Video Screens
 Time/Temperature Boards

Maximum Ratings (Ta=25°C)

Characteristic	Symbol	Max.	Unit
Forward Current	I _F	50	mA
Reverse Voltage	V _R	5.00	V
Power Dissipation	P _D	200.00	mW
Operating Temperature	T _{opr}	-40 ~ +95	°C
Storage Temperature	T _{stg}	-40 ~ +100	°C
Soldering Temperature	T _{sol}	260	°C
Soldering Time	-	for 5 sec. max	-

Opto-Electrical Characteristics (Ta=25°C)

Characteristic	Symbol	Test Condition	Min	Typ	Max	Unit
Forward Voltage	V _F	I _F =20mA	1.70	2.00	2.50	V
Reverse Current	I _R	V _R =5V	-	-	100	µA
Luminous Intensity	I _v	I _F =20mA	280.00	400.00	-	mcd
Viewing Angle	2θ ^{1/2}	-	-	100° x 40°	-	deg.
Peak Wavelength	λ _p	I _F =20mA	-	630	-	nm
Dominant Wavelength	λ _d	I _F =20mA	-	624	-	nm
Spectral Line Half Width	Δλ	I _F =20mA	-	23	-	nm

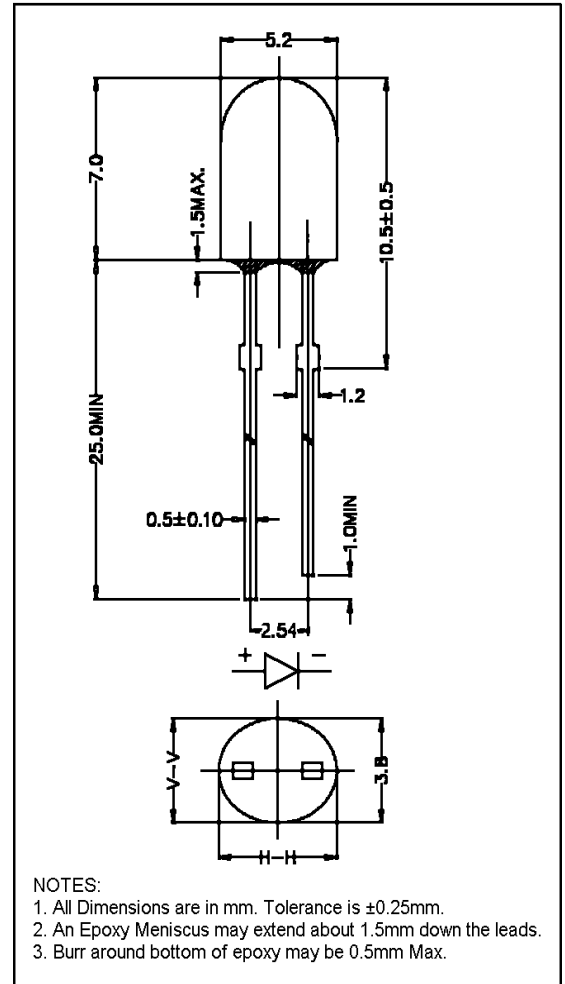

Company Headquarters
 120 Broadway
 Menands, New York 12204
 Toll Free: 800.984.5337
 Fax: 518.432.7454



Web: www.marktechopto.com | Email: info@marktechopto.com

West Coast Sales Office
 950 South Coast Drive, Suite 265
 Costa Mesa, California 92626
 Toll Free: 800.984.5337
 Fax: 714.850.9314

LO564NHR4-B0G Graphs

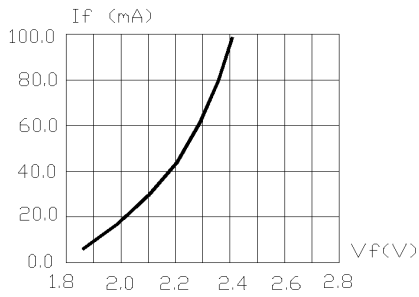

FIG.1 FORWARD CURRENT VS. FORWARD VOLTAGE.

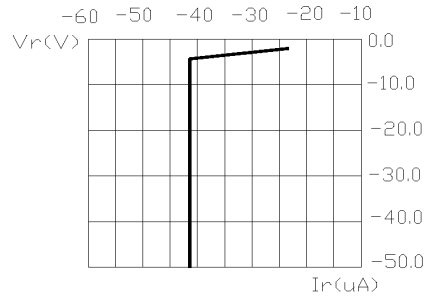

FIG.2 REVERSE CURRENT VS. REVERSE VOLTAGE.

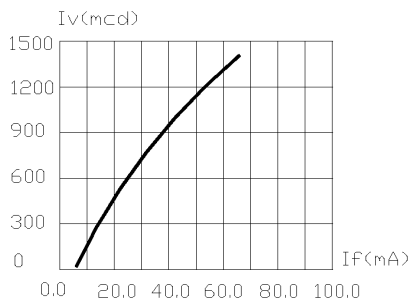

FIG.3 RELATIVE LUMINOUS INTENSITY VS. FORWARD CURRENT.

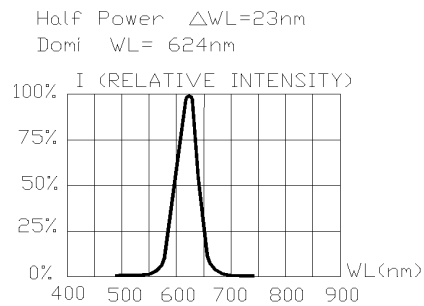

FIG.4 RELATIVE INTENSITY VS. WAVE LENGTH.

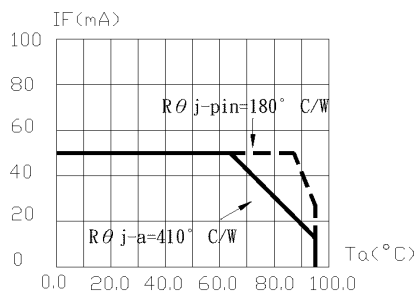

FIG.5 MAXIMUM FORWARD DC CURRENT VS TEMPERATURE. DERATING BASED ON $T_{jmax}=105^{\circ}C$

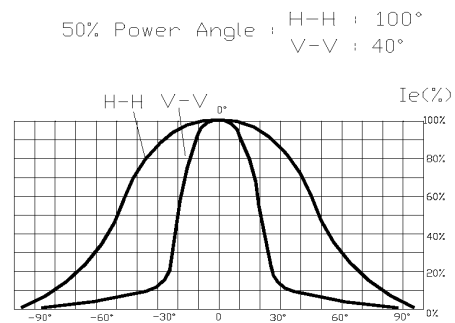

FIG.6 SPATIAL DISTRIBUTION.

1. Cathode PAD Area ($0.18 \times 0.18 \text{ inch}^2$)
2. Height above nominal seating plane in inches (0.3inch)