

NEC

User's Manual

IE-78K0-NS-PA

Performance Board

Target Devices
78K/0 Series

Document No. U16109EJ1V0UM00 (1st edition)
Date Published June 2002 N CP(K)

© NEC Corporation 2002
Printed in Japan

[MEMO]

V40 Family is a trademark of NEC Corporation.

Windows is either a registered trademark or a trademark of Microsoft Corporation in the United States and/or other countries.

PC/AT is a trademark of International Business Machines Corporation.

• **The information in this document is current as of May, 2002. The information is subject to change without notice. For actual design-in, refer to the latest publications of NEC's data sheets or data books, etc., for the most up-to-date specifications of NEC semiconductor products. Not all products and/or types are available in every country. Please check with an NEC sales representative for availability and additional information.**

• No part of this document may be copied or reproduced in any form or by any means without prior written consent of NEC. NEC assumes no responsibility for any errors that may appear in this document.

• NEC does not assume any liability for infringement of patents, copyrights or other intellectual property rights of third parties by or arising from the use of NEC semiconductor products listed in this document or any other liability arising from the use of such products. No license, express, implied or otherwise, is granted under any patents, copyrights or other intellectual property rights of NEC or others.

• Descriptions of circuits, software and other related information in this document are provided for illustrative purposes in semiconductor product operation and application examples. The incorporation of these circuits, software and information in the design of customer's equipment shall be done under the full responsibility of customer. NEC assumes no responsibility for any losses incurred by customers or third parties arising from the use of these circuits, software and information.

• While NEC endeavours to enhance the quality, reliability and safety of NEC semiconductor products, customers agree and acknowledge that the possibility of defects thereof cannot be eliminated entirely. To minimize risks of damage to property or injury (including death) to persons arising from defects in NEC semiconductor products, customers must incorporate sufficient safety measures in their design, such as redundancy, fire-containment, and anti-failure features.

• NEC semiconductor products are classified into the following three quality grades:

"Standard", "Special" and "Specific". The "Specific" quality grade applies only to semiconductor products developed based on a customer-designated "quality assurance program" for a specific application. The recommended applications of a semiconductor product depend on its quality grade, as indicated below. Customers must check the quality grade of each semiconductor product before using it in a particular application.

"Standard": Computers, office equipment, communications equipment, test and measurement equipment, audio and visual equipment, home electronic appliances, machine tools, personal electronic equipment and industrial robots

"Special": Transportation equipment (automobiles, trains, ships, etc.), traffic control systems, anti-disaster systems, anti-crime systems, safety equipment and medical equipment (not specifically designed for life support)

"Specific": Aircraft, aerospace equipment, submersible repeaters, nuclear reactor control systems, life support systems and medical equipment for life support, etc.

The quality grade of NEC semiconductor products is "Standard" unless otherwise expressly specified in NEC's data sheets or data books, etc. If customers wish to use NEC semiconductor products in applications not intended by NEC, they must contact an NEC sales representative in advance to determine NEC's willingness to support a given application.

(Note)

(1) "NEC" as used in this statement means NEC Corporation and also includes its majority-owned subsidiaries.

(2) "NEC semiconductor products" means any semiconductor product developed or manufactured by or for NEC (as defined above).

M8E 00.4

Regional Information

Some information contained in this document may vary from country to country. Before using any NEC product in your application, please contact the NEC office in your country to obtain a list of authorized representatives and distributors. They will verify:

- Device availability
- Ordering information
- Product release schedule
- Availability of related technical literature
- Development environment specifications (for example, specifications for third-party tools and components, host computers, power plugs, AC supply voltages, and so forth)
- Network requirements

In addition, trademarks, registered trademarks, export restrictions, and other legal issues may also vary from country to country.

NEC Electronics Inc. (U.S.)

Santa Clara, California
Tel: 408-588-6000
800-366-9782
Fax: 408-588-6130
800-729-9288

NEC do Brasil S.A.

Electron Devices Division
Guarulhos-SP, Brasil
Tel: 11-6462-6810
Fax: 11-6462-6829

NEC Electronics (Europe) GmbH

Duesseldorf, Germany
Tel: 0211-65 03 01
Fax: 0211-65 03 327

• Sucursal en España

Madrid, Spain
Tel: 091-504 27 87
Fax: 091-504 28 60

• Succursale Française

Vélizy-Villacoublay, France
Tel: 01-30-67 58 00
Fax: 01-30-67 58 99

• Filiale Italiana

Milano, Italy
Tel: 02-66 75 41
Fax: 02-66 75 42 99

• Branch The Netherlands

Eindhoven, The Netherlands
Tel: 040-244 58 45
Fax: 040-244 45 80

• Branch Sweden

Taeby, Sweden
Tel: 08-63 80 820
Fax: 08-63 80 388

• United Kingdom Branch

Milton Keynes, UK
Tel: 01908-691-133
Fax: 01908-670-290

NEC Electronics Hong Kong Ltd.

Hong Kong
Tel: 2886-9318
Fax: 2886-9022/9044

NEC Electronics Hong Kong Ltd.

Seoul Branch
Seoul, Korea
Tel: 02-528-0303
Fax: 02-528-4411

NEC Electronics Shanghai, Ltd.

Shanghai, P.R. China
Tel: 021-6841-1138
Fax: 021-6841-1137

NEC Electronics Taiwan Ltd.

Taipei, Taiwan
Tel: 02-2719-2377
Fax: 02-2719-5951

NEC Electronics Singapore Pte. Ltd.

Novena Square, Singapore
Tel: 253-8311
Fax: 250-3583

INTRODUCTION

- Product overview** The IE-78K0-NS-PA is used in combination with an in-circuit emulator (IE-78K0-NS), emulation board (IE-780xxx-NS-EM1, IE-780xxx-NS-EM4), and I/O board (IE-78K0-NS-P0x) to debug products of the 78K/0 Series of 8-bit single-chip microcontrollers.
- Target readers** This manual is intended for engineers who perform debugging of systems that employ the 78K/0 Series of 8-bit single-chip microcontrollers using the IE-78K0-NS-PA and an in-circuit emulator (IE-78K0-NS), emulation board (IE-780xxx-NS-EM1, IE-780xxx-NS-EM4), and I/O board (IE-78K0-NS-P0x) together.
- Purpose** The purpose of this manual is to help the user understand the debugging functions that are available by using the IE-78K0-NS-PA and the in-circuit emulator (IE-78K0-NS), emulation board (IE-780xxx-NS-EM1, IE-780xxx-NS-EM4), and I/O board (IE-78K0-NS-P0x) together.
- Organization** When using the IE-78K0-NS-PA, please refer to the manual (this manual) that comes with the IE-78K0-NS-PA as well as the manual that comes with the in-circuit emulator (IE-78K0-NS), emulation board (IE-780xxx-NS-EM1, IE-780xxx-NS-EM4), and I/O board (IE-78K0-NS-P0x).

IE-78K0-NS
User's Manual

- General
- Part names
- Installation
- External interface

IE-78K0-NS-PA
User's Manual
(This manual)

- General
- Part names
- Installation
- External sense specifications
- Cautions

IE-78K0-NS-P0x
User's Manual

- General
- Part names
- Installation

IE-780xxx-NS-EM1
IE-780xxx-NS-EM4
User's Manual

- General
- Part names
- Installation
- Differences between target devices and target interface circuits

How to read this manual To understand the overall functions of the IE-78K0-NS-PA:
→ Read this manual in the order of the contents.

To understand the basic specifications:
→ Refer to **CHAPTER 1 GENERAL** and **CHAPTER 2 PART NAMES**.

For how to connect the IE-78K0-NS, IE-780xxx-NS-EM1, IE-780xxx-NS-EM4, and IE-78K0-NS-P0x and make settings to debug 78K/0 Series products:
→ Refer to **CHAPTER 3 INSTALLATION**.

Terminology The meanings of the terms used in this manual are described in the table below.

Term	Meaning
Target device	This is the device to be emulated.
Target system	This is the system to be debugged. This includes the target program and the hardware provided by the user. When defined narrowly, it includes only the hardware.
IE system	This refers to the combination of an in-circuit emulator (IE-78K0-NS), emulation board (IE-780xxx-NS-EMx), and I/O board (IE-78K0-NS-P0x).

Conventions

Data significance: Higher digits on the left and lower digits on the right

Note: Footnote for item marked with **Note** in the text

Caution: Information requiring particular attention

Remark: Supplementary information

Related documents The related documents (user's manuals) indicated in this publication may include preliminary versions. However, preliminary versions are not marked as such.

Document Name	Document No.
IE-78K0-NS In-Circuit Emulator	U13731E
IE-78K0-NS-PA Performance Board	This manual
ID78K Series Integrated Debugger Ver. 2.30 or Later Operation (Windows™ Based)	U15185E

Caution The related documents listed above are subject to change without notice. Be sure to use the latest version of each document for designing.

CONTENTS

CHAPTER 1 GENERAL	11
1.1 System Configuration	11
1.2 Hardware Configuration	13
1.3 Basic Specifications	14
CHAPTER 2 PART NAMES	16
2.1 Parts of Main Unit	17
2.2 External Sense Probe Names	18
CHAPTER 3 INSTALLATION	19
CHAPTER 4 EXTERNAL SENSE SPECIFICATIONS	26
CHAPTER 5 CAUTIONS	27

LIST OF FIGURES

Figure No.	Title	Page
1-1	IE-78K0-NS-PA System Configuration	12
1-2	Basic Hardware Configuration	13
2-1	Performance Board	17
3-1	Connecting Emulation Board (IE-780xxx-NS-EM1)	20
3-2	Connecting I/O Board (IE-78K0-NS-P0x) and Emulation Board (IE-780xxx-NS-EM4)	22
3-3	Connecting External Sense Probe	24
3-4	Connecting Emulation Probe	25

LIST OF TABLES

Table No.	Title	Page
1-1	List of Functions (MAX. Specifications)	14
2-1	Correspondence Between Connector No. and Color of Cable	18
2-2	Bit Configuration When Connecting External Sense Probe to EXTCN1.....	18
2-3	Bit Configuration When Connecting External Sense Probe to EXTCN2.....	18
4-1	Electrical Specifications of External Sense.....	26

CHAPTER 1 GENERAL

The IE-78K0-NS-PA is a development tool for effectively debugging hardware and software in which a 78K/0 Series 8-bit single-chip microcontroller is used as the target device.

This chapter describes the system configuration and basic specifications of the IE-78K0-NS-PA.

1.1 System Configuration

Figure 1-1 shows the system configuration of the IE-78K0-NS-PA.

Figure 1-1. IE-78K0-NS-PA System Configuration

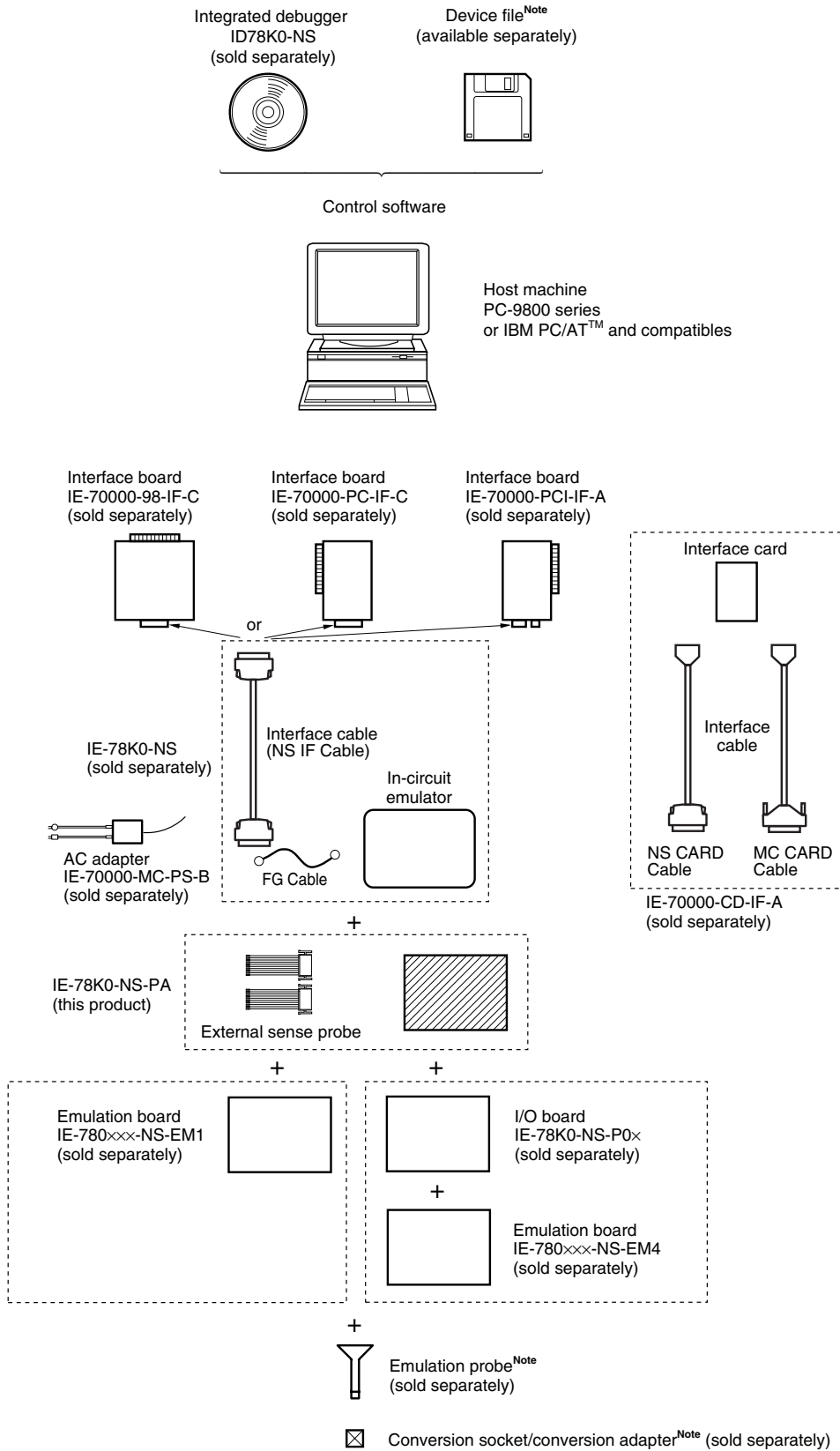

Note For the device file, emulation probe, and conversion socket/conversion adapter, refer to the IE-780xxx-NS-EM1 or IE-780xxx-NS-EM4 User's Manual.

1.2 Hardware Configuration

The position of the IE-78K0-NS-PA is shown in Figure 1-2.

Figure 1-2. Basic Hardware Configuration

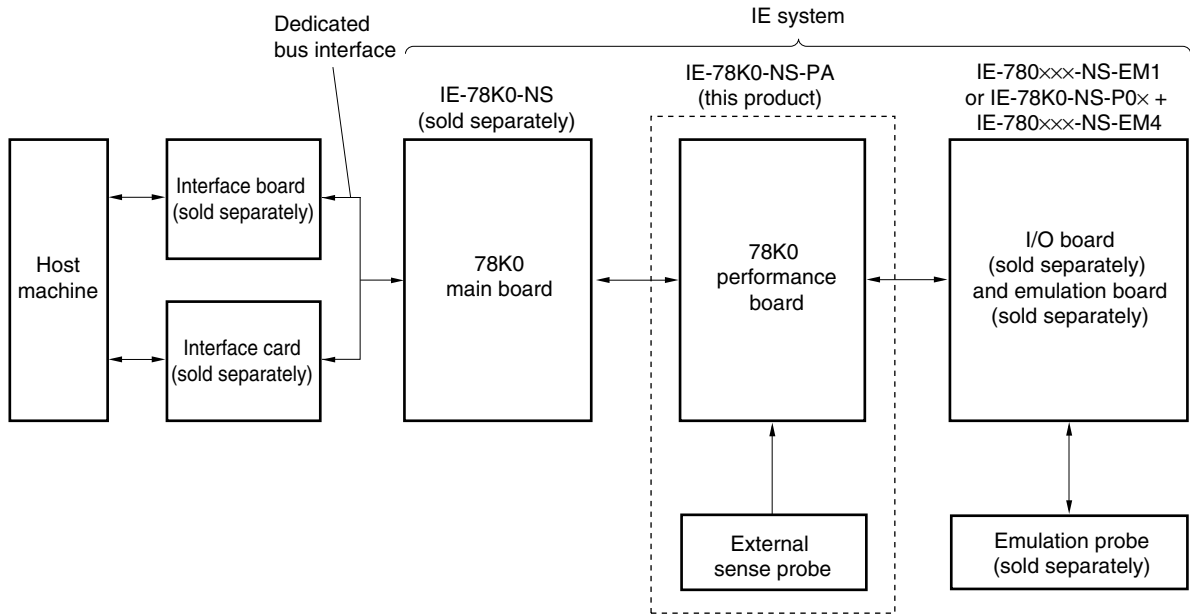

1.3 Basic Specifications

Table 1-1. List of Functions (MAX. Specifications) (1/2)

Parameter		IE-78K0-NS Single Unit Functions	Functions Added by Combining IE-78K0-NS with IE-78K0-NS-PA
Supervisor		V40™ (operating frequency: 16.0 MHz)	
Target device		78K/0 Series (μ PD780xxx)	
System clock		According to specification of emulation board (sold separately)	
Clock supply	External	Pulse input	
	Internal	Mounted on emulation board (sold separately)	
Substitute memory capacity		64 KB	
Mapping unit	Internal ROM	4 KB	
	Internal high-speed RAM	64 bytes	
	Internal low-speed RAM	128 bytes	
	External expansion memory	8 KB	
Emulation function		<ul style="list-style-type: none"> • Real-time execution • Break execution • Step execution 	
Real-time internal RAM monitor		2 KB of entire data memory space	
Event detection		<ul style="list-style-type: none"> • Program execution detection: 2 (fetch) (BRS1, BRS2) • Bus event detection: 4 (access) (BRA1 to BRA4) 	<ul style="list-style-type: none"> • Program execution detection: 8 (fetch) (BRS3 to BRS10) • Bus event detection: 8 (access) (BRA5 to BRA12)
Event integration		<ul style="list-style-type: none"> • Trigger condition • Path condition • Delay condition • Trace qualify condition 	
Break factors		<ul style="list-style-type: none"> • External trigger detection (EXTIN: 1) • Trigger output OUT (open-drain output: 1) • Event break • Manual break • Command break • Fail-safe break 	<ul style="list-style-type: none"> • External event inputs (EXTCN1: 8) • Timeout break
Real-time trace	Trace factors	<ul style="list-style-type: none"> • All traces • Qualify trace (access only) 	<ul style="list-style-type: none"> • Section trace (both fetch and access) (inter-event trace)^{Note}
	Trace capacity	32 bits \times 8 KB	48 bits \times 8 KB
	Trace contents	<ul style="list-style-type: none"> • Address • Data • Status 	<ul style="list-style-type: none"> • External sense traces: 16 (8 of which (EXTCN1) can be used as external single event inputs) • Time stamp • Snap shot

Note Events use BRS3 to BRS10 and BRA5 to BRA12 added by the IE-78K0-NS-PA.

Table 1-1. List of Functions (MAX. Specifications) (2/2)

Parameter	IE-78K0-NS Single Unit Functions	Functions Added by Combining IE-78K0-NS with IE-78K0-NS-PA
Execution time measurement	Up to 4 min 28 s, resolution: 62.5 ns	
Inter-event time measurement	–	<ul style="list-style-type: none"> • Resolution: Changeable between 160 ns and 20.56 μs • Maximum measurement time When resolution is set to 160 ns: Approximately 11 minutes When resolution is set to 20.56 μs: Approximately 24 hours^{Note}
Coverage	–	64 KB space (read, write, fetch)
DMM	–	16 events ^{Note}
Target interface	Emulation probe (sold separately) provided for each target device shape	
Host interface	Dedicated bus interface	
Low-voltage support	According to specification of emulation board (sold separately)	
Host machine	PC-9800 series, or IBM PC/AT and compatibles	
Power supply	DC 5 V	
Dimensions	W240 × D197 × H73 (mm)	

Note Events use BRS3 to BRS10 and BRA5 to BRA12 added by the IE-78K0-NS-PA.

CHAPTER 2 PART NAMES

This chapter introduces the parts of the IE-78K0-NS-PA main unit.

The packing box contains the performance board, 2 external sense probes, 20 external sense clips, a packing list, the user's manual, and a guarantee card.

If there are any missing or damaged items, please contact an NEC sales representative.

Please make sure to fill out and return the guarantee card that comes with the main unit.

2.1 Parts of Main Unit

Figure 2-1. Performance Board

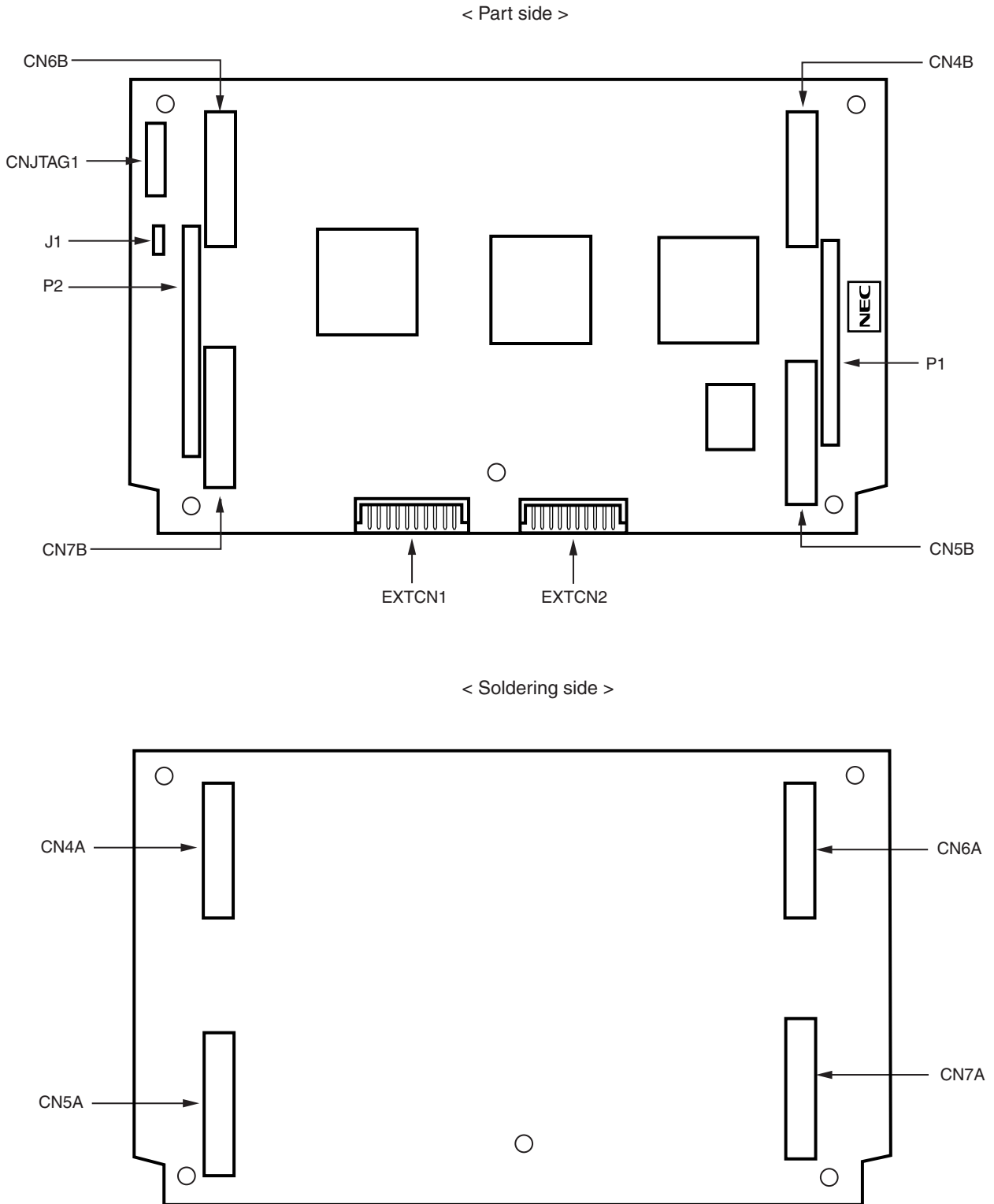

2.2 External Sense Probe Names

The IE-78K0-NS-PA includes external sense probes and external sense clips.

(1) External sense probes: 2

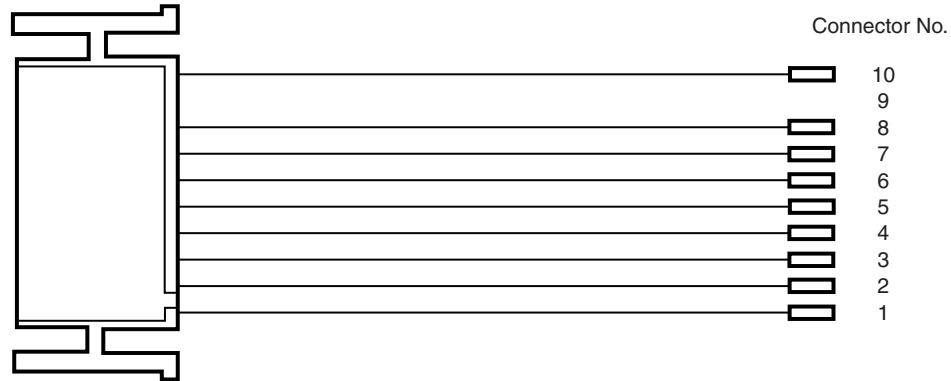

Table 2-1. Correspondence Between Connector No. and Color of Cable

Connector No.	1	2	3	4	5	6	7	8	9	10
Color of cable	Brown	Red	Orange	Yellow	Green	Blue	Purple	Gray	N.C.	Black

The names of the external sense probes when they are connected to EXTCN1 and EXTCN2 are as follows.

Table 2-2. Bit Configuration When Connecting External Sense Probe to EXTCN1

Connector No.	1	2	3	4	5	6	7	8	9	10
External sense	EXT1	EXT2	EXT3	EXT4	EXT5	EXT6	EXT7	EXT8	N.C.	GND

Table 2-3. Bit Configuration When Connecting External Sense Probe to EXTCN2

Connector No.	1	2	3	4	5	6	7	8	9	10
External sense	EXT9	EXT10	EXT11	EXT12	EXT13	EXT14	EXT15	EXT16	N.C.	GND

Remark N.C.: No connection

(2) External sense clips: 20 (16 for external sense probes, 2 for GND, and 2 spares)

- Made by Sunhayato Corporation (2 sets of 10)

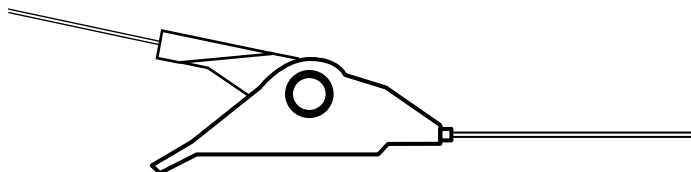

CHAPTER 3 INSTALLATION

This chapter describes how to connect the IE-78K0-NS-PA to the IE-78K0-NS, emulation board, etc.

Caution Connecting and removing cables or components from the target system and changing the settings of switches, etc. should be carried out after turning off the power supply of the IE system and the target system.

(1) Connecting emulation board (IE-780xxx-NS-EM1)

The IE-780xxx-NS-EM1 is sold separately.

Figure 3-1. Connecting Emulation Board (IE-780xxx-NS-EM1) (1/2)

<1> Remove the screws from the sides of the main unit, and then remove the top cover.

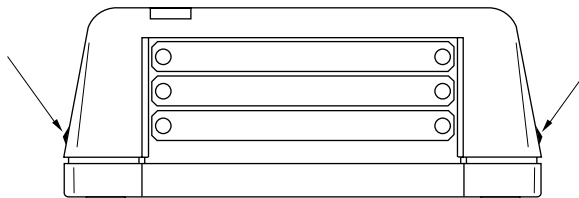

<2> Remove the first and second plates from the bottom by removing the screws.

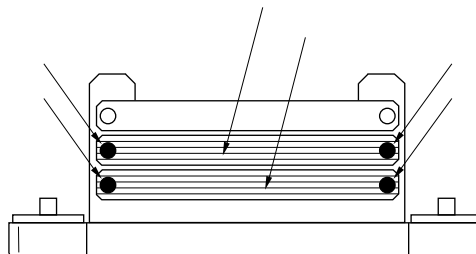

<3> Connect the IE-78K0-NS-PA and fix the spacers (metal) included with this product at five points on the board.

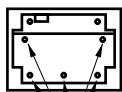

Fix here

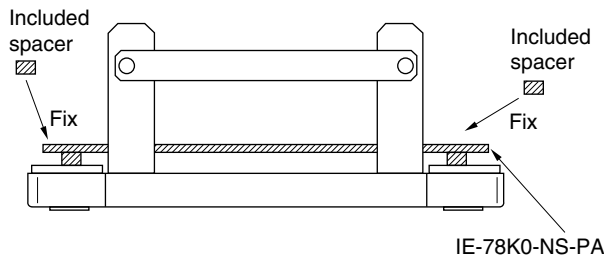

Caution Only when connecting the IE-78018-NS-EM1 on the IE-78K0-NS-PA, remove spacer 1 (metal) of the following figure and replace spacers 2 and 3 (metal) with spacers (plastic) included with this product.

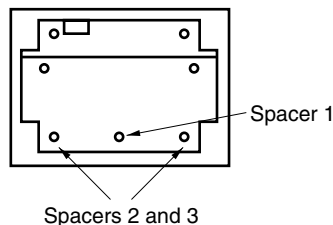

<4> Connect the IE-780xxx-NS-EM1 to the IE-78K0-NS-PA and fasten the two screws.

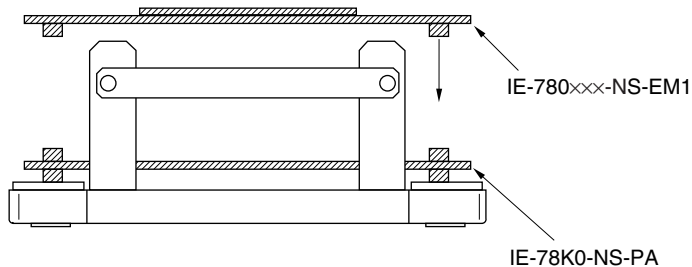

<5> When using an emulation probe, connect the corresponding emulation probe.

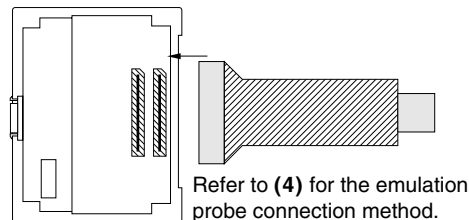

Refer to (4) for the emulation probe connection method.

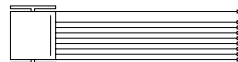

Refer to (3) for the external sense probe connection method.

Figure 3-1. Connecting Emulation Board (IE-780xxx-NS-EM1) (2/2)

- <6> Replace the top cover and fasten the four screws on the sides.

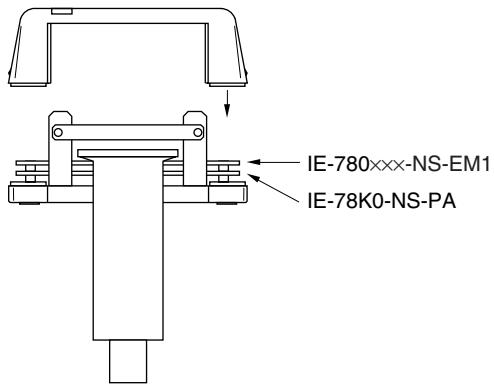

(2) Connecting I/O board (IE-78K0-NS-P0x) and emulation board (IE-780xxx-NS-EM4)

The IE-78K0-NS-P0x and IE-780xxx-NS-EM4 are sold separately.

Figure 3-2. Connecting I/O Board (IE-78K0-NS-P0x) and Emulation Board (IE-780xxx-NS-EM4) (1/2)

<1> Remove the screws from the sides of the main unit, and then remove the top cover.

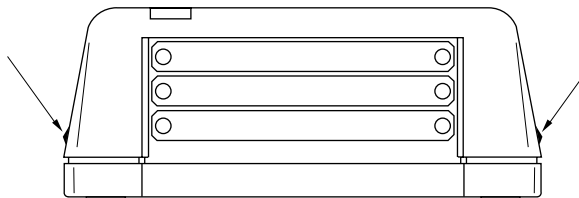

<2> Remove the first and third plates from the bottom by removing the screws.

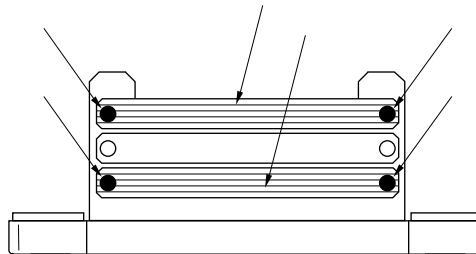

<3> Connect the IE-78K0-NS-PA and fix the spacers (metal) included with this product at five points on the board.

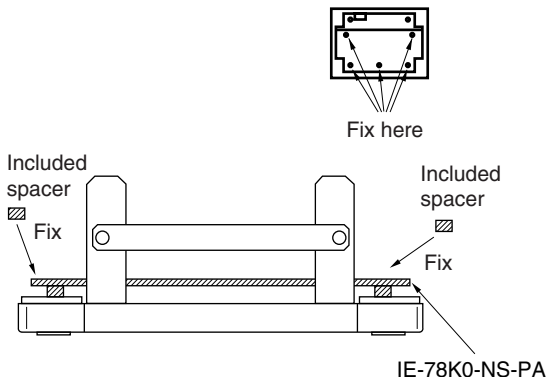

<4> Connect the IE-78K0-NS-P0x on the IE-78K0-NS-PA and fix the spacers included with the IE-78K0-NS-P0x at the four corners.

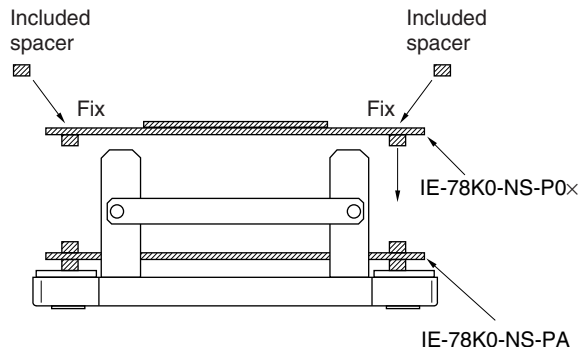

<5> Connect the IE-780xxx-NS-EM4 on the IE-78K0-NS-P0x, and fasten the screws at the four corners.

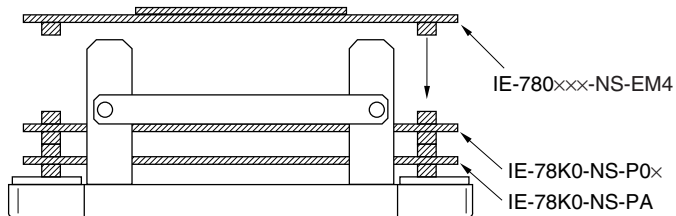

<6> When using an emulation probe, connect the corresponding emulation probe.

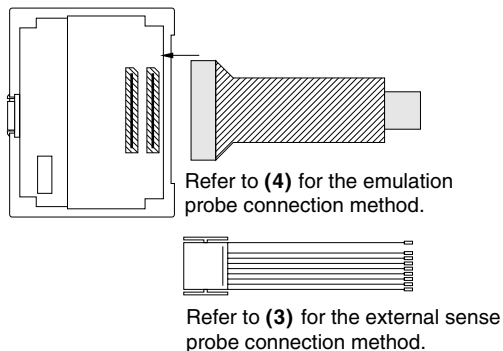
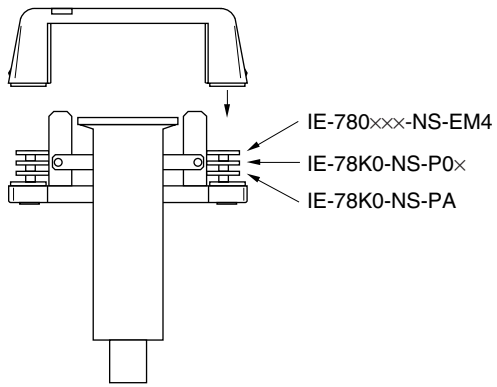

Figure 3-2. Connecting I/O Board (IE-78K0-NS-P0x) and Emulation Board (IE-780xxx-NS-EM4) (2/2)

- <7> Replace the top cover and fasten the four screws on the sides.



(3) Connecting external sense probe

Figure 3-3. Connecting External Sense Probe

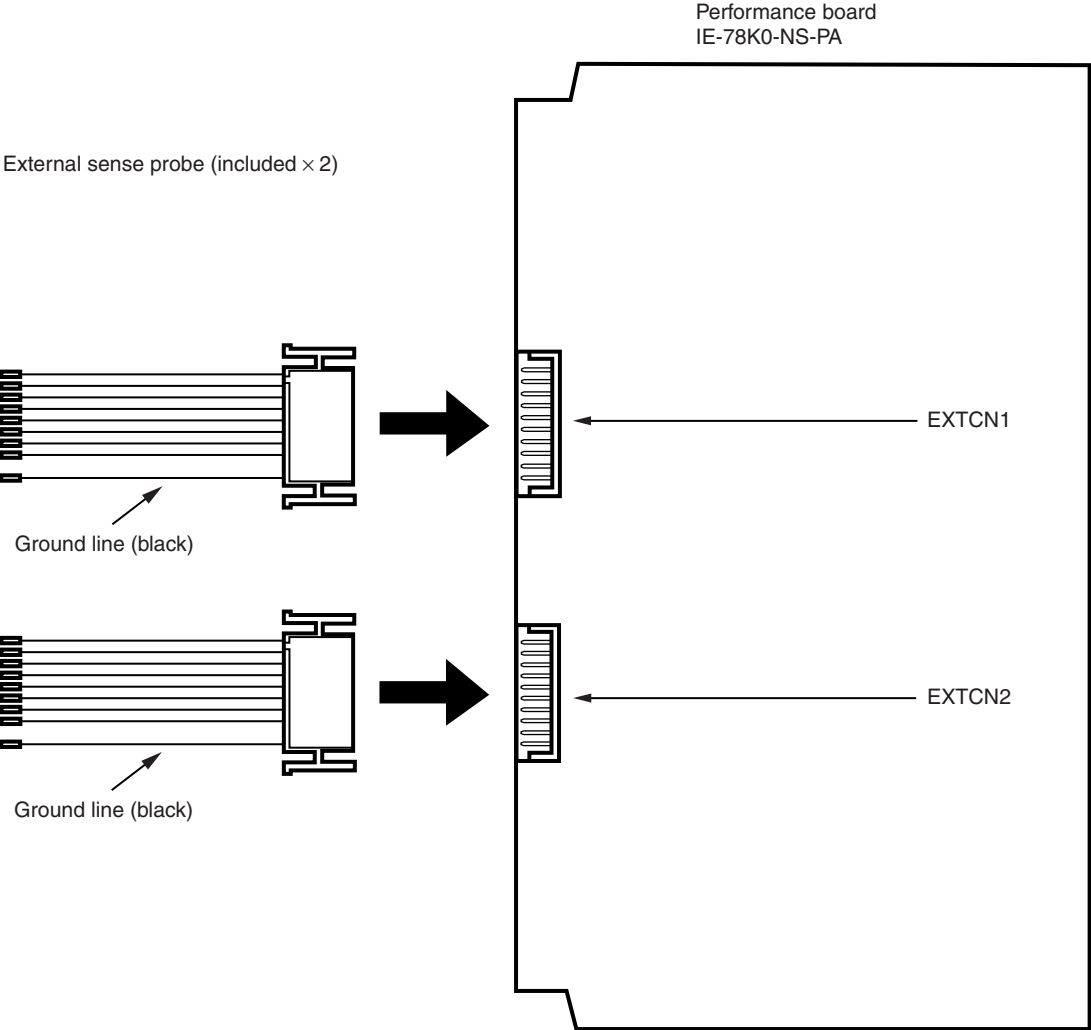

(4) Connecting emulation probe (NP-xxxxx)

NP-xxxxx is sold separately.

Figure 3-4. Connecting Emulation Probe

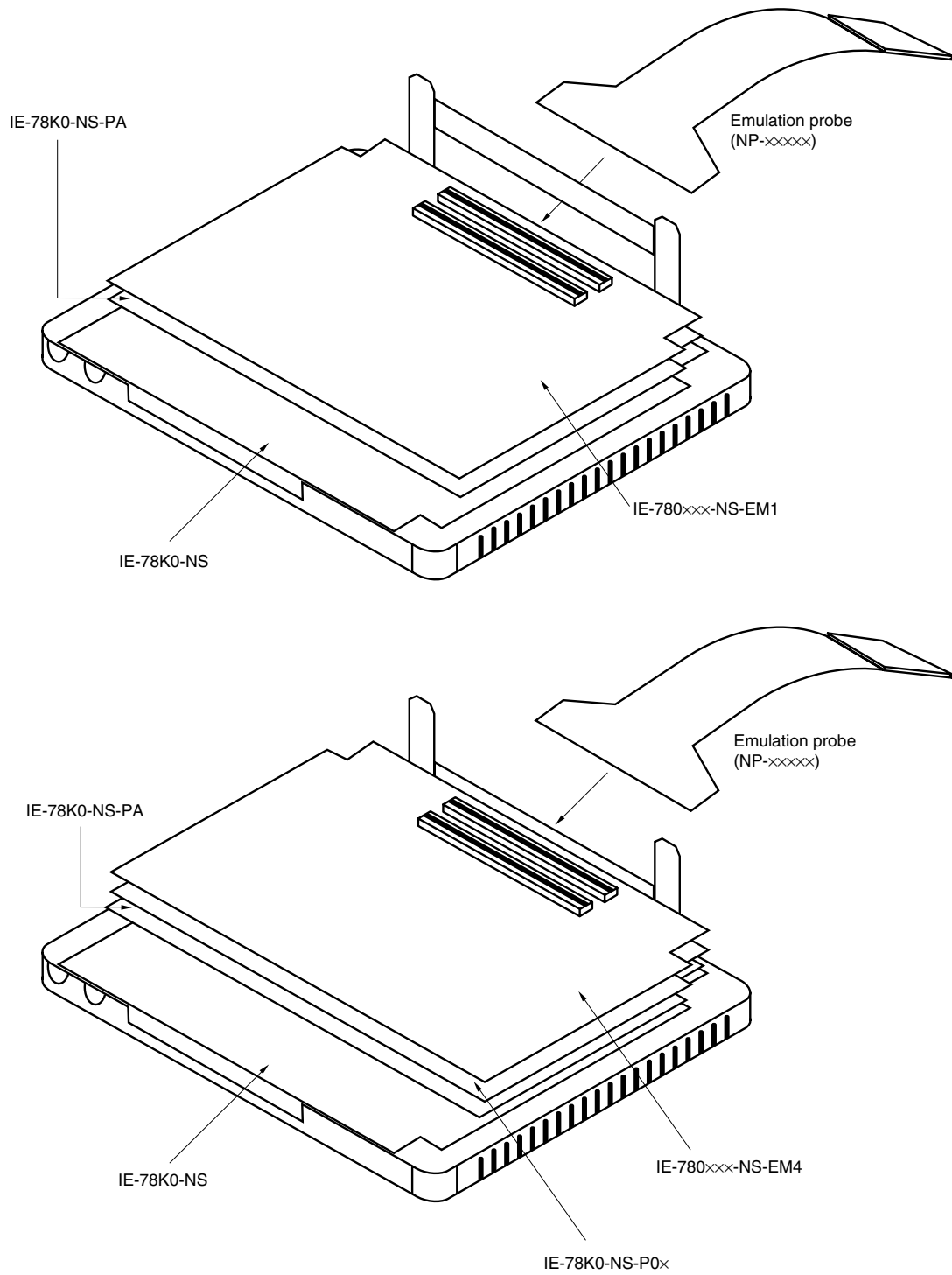

Caution The emulation probe (NP-xxxxx) mounting location varies depending on the emulation board in use. For details, refer to the user's manual of the corresponding emulation board.

CHAPTER 4 EXTERNAL SENSE SPECIFICATIONS

Up to 16-bit data can be input to the IE-78K0-NS-PA from the target system via an external sense probe. Also, when using an external event input, input a level of at least 2 CPU clocks.

Table 4-1. Electrical Specifications of External Sense

Parameter	MIN. [V]	MAX. [V]
Input voltage, high	Target voltage ^{Note} × 0.7	Target voltage ^{Note}
Input voltage, low	0	Target voltage ^{Note} × 0.3

Note 2.0 V when the target voltage is less than 2.0 V.

CHAPTER 5 CAUTIONS

- (1) When debugging is performed by connecting the performance board IE-78K0-NS-PA to the in-circuit emulator IE-78K0-NS and the corresponding emulation board, use an in-circuit emulator or an integrated debugger that satisfies the following conditions.
 - Use an in-circuit emulator IE-78K0-NS with control code D or later.
 - Use version 2.00 or later of the integrated debugger ID78K0-NS.

- (2) If it is set that DMM or snap shot occurs during the measurement section of the execution time, the execution time measurement value becomes larger than the actual value.
 - Countermeasure: Do not specify DMM or snap shot during the measurement section of the execution time.

- (3) When section trace is specified and then DMM or snap shot is specified, the trace data may not appear correctly.
 - Countermeasure: Do not set a DMM or snap shot event when performing a section trace.
Do not set a section trace when performing a DMM or snap shot event.

[MEMO]

[MEMO]

[MEMO]

Facsimile Message

Although NEC has taken all possible steps to ensure that the documentation supplied to our customers is complete, bug free and up-to-date, we readily accept that errors may occur. Despite all the care and precautions we've taken, you may encounter problems in the documentation. Please complete this form whenever you'd like to report errors or suggest improvements to us.

From:

Name

Company

Tel.

FAX

Address

Thank you for your kind support.

North America

NEC Electronics Inc.
Corporate Communications Dept.
Fax: +1-800-729-9288
+1-408-588-6130

Hong Kong, Philippines, Oceania

NEC Electronics Hong Kong Ltd.
Fax: +852-2886-9022/9044

Taiwan

NEC Electronics Taiwan Ltd.
Fax: +886-2-2719-5951

Europe

NEC Electronics (Europe) GmbH
Market Communication Dept.
Fax: +49-211-6503-274

Korea

NEC Electronics Hong Kong Ltd.
Seoul Branch
Fax: +82-2-528-4411

Asian Nations except Philippines

NEC Electronics Singapore Pte. Ltd.
Fax: +65-250-3583

South America

NEC do Brasil S.A.
Fax: +55-11-6462-6829

P.R. China

NEC Electronics Shanghai, Ltd.
Fax: +86-21-6841-1137

Japan

NEC Semiconductor Technical Hotline
Fax: +81-44-435-9608

I would like to report the following error/make the following suggestion:

Document title: _____

Document number: _____

Page number: _____

If possible, please fax the referenced page or drawing.

Document Rating	Excellent	Good	Acceptable	Poor
Clarity	<input type="checkbox"/>	<input type="checkbox"/>	<input type="checkbox"/>	<input type="checkbox"/>
Technical Accuracy	<input type="checkbox"/>	<input type="checkbox"/>	<input type="checkbox"/>	<input type="checkbox"/>
Organization	<input type="checkbox"/>	<input type="checkbox"/>	<input type="checkbox"/>	<input type="checkbox"/>