

# SHINDENGEN

## VX-2 Series Power MOSFET

N-Channel Enhancement type

**2SK2193**  
**(FP12W50VX2)**

**500V 12A**

### FEATURES

- Input capacitance (Ciss) is small.  
Especially, input capacitance at 0 bias is small.
- The static Rds(on) is small.
- The switching time is fast.

### APPLICATION

- Switching power supply of AC 100V input
- High voltage power supply
- Inverter

### RATINGS

#### ● Absolute Maximum Ratings (Tc = 25°C)

Item	Symbol	Conditions	Ratings	Unit
Storage Temperature	T <sub>stg</sub>		-55~150	°C
Channel Temperature	T <sub>ch</sub>		150	
Drain-Source Voltage	V <sub>DSS</sub>		500	V
Gate-Source Voltage	V <sub>GS</sub>		±30	
Continuous Drain Current (DC)	I <sub>D</sub>		12	A
Continuous Drain Current (Peak)	I <sub>DP</sub>		36	
Continuous Source Current (DC)	I <sub>S</sub>		12	
Total Power Dissipation	P <sub>T</sub>		50	W
Single Pulse Avalanche Current	I <sub>AS</sub>	T <sub>ch</sub> = 25°C	12	A
Dielectric Strength	V <sub>dis</sub>	Terminals to case, AC 1 minute	2	kV
Mounting Torque	TOR	( Recommended torque : 0.5N·m )	0.8	N·m

### OUTLINE DIMENSIONS

Case : ITO-3P

(Unit : mm)

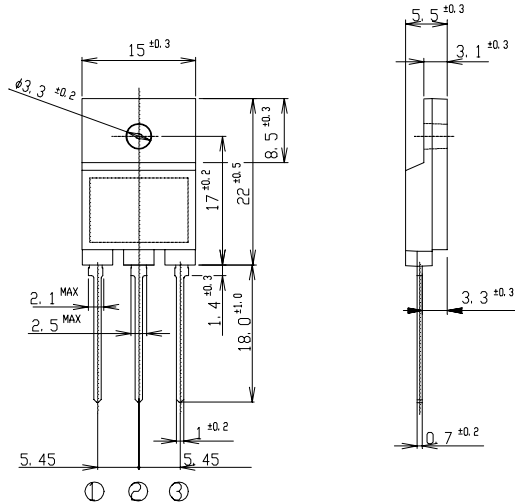

⊙ : G  
⊖ : D  
⊕ : S

●Electrical Characteristics  $T_c = 25^\circ\text{C}$

Item	Symbol	Conditions	Min.	Typ.	Max.	Unit
Drain-Source Breakdown Voltage	$V_{(BR)DSS}$	$I_D = 1\text{mA}, V_{GS} = 0\text{V}$	500			V
Zero Gate Voltage Drain Current	$I_{DSS}$	$V_{DS} = 500\text{V}, V_{GS} = 0\text{V}$			250	$\mu\text{A}$
Gate-Source Leakage Current	$I_{GSS}$	$V_{GS} = \pm 30\text{V}, V_{DS} = 0\text{V}$			$\pm 0.1$	
Forward Transconductance	$g_{fs}$	$I_D = 6\text{A}, V_{DS} = 10\text{V}$	3.0	7.6		S
Static Drain-Source On-state Resistance	$R_{DS(ON)}$	$I_D = 6\text{A}, V_{GS} = 10\text{V}$		0.55	0.7	$\Omega$
Gate Threshold Voltage	$V_{TH}$	$I_D = 1\text{mA}, V_{DS} = 10\text{V}$	2.5	3.0	3.5	V
Source-Drain Diode Forwade Voltage	$V_{SD}$	$I_S = 6\text{A}, V_{GS} = 0\text{V}$			1.5	
Thermal Resistance	$\theta_{jc}$	junction to case			2.5	$^\circ\text{C}/\text{W}$
Total Gate Charge	$Q_g$	$V_{DD} = 400\text{V}, V_{GS} = 10\text{V}, I_D = 12\text{A}$		42		nC
Input Capacitance	$C_{iss}$	$V_{DS} = 10\text{V}, V_{GS} = 0\text{V}, f = 1\text{MHz}$		1200		pF
Reverse Transfer Capacitance	$C_{rss}$			90		
Output Capacitance	$C_{oss}$			270		
Turn-On Time	$t_{on}$	$I_D = 6\text{A}, V_{GS} = 10\text{V}, R_L = 25\Omega$		90	130	ns
Turn-Off Time	$t_{off}$			190	280	

# 2SK2193

# Transfer Characteristics

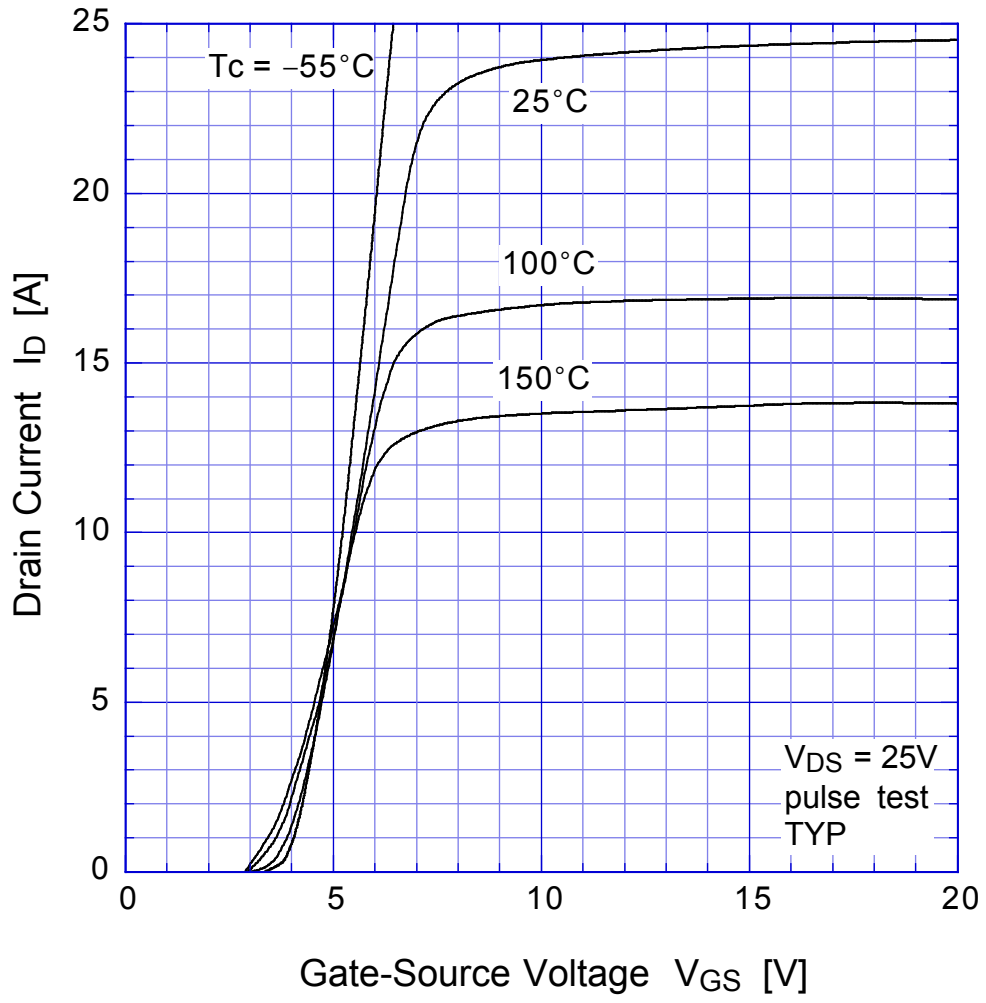

## 2SK2193 Static Drain-Source On-state Resistance

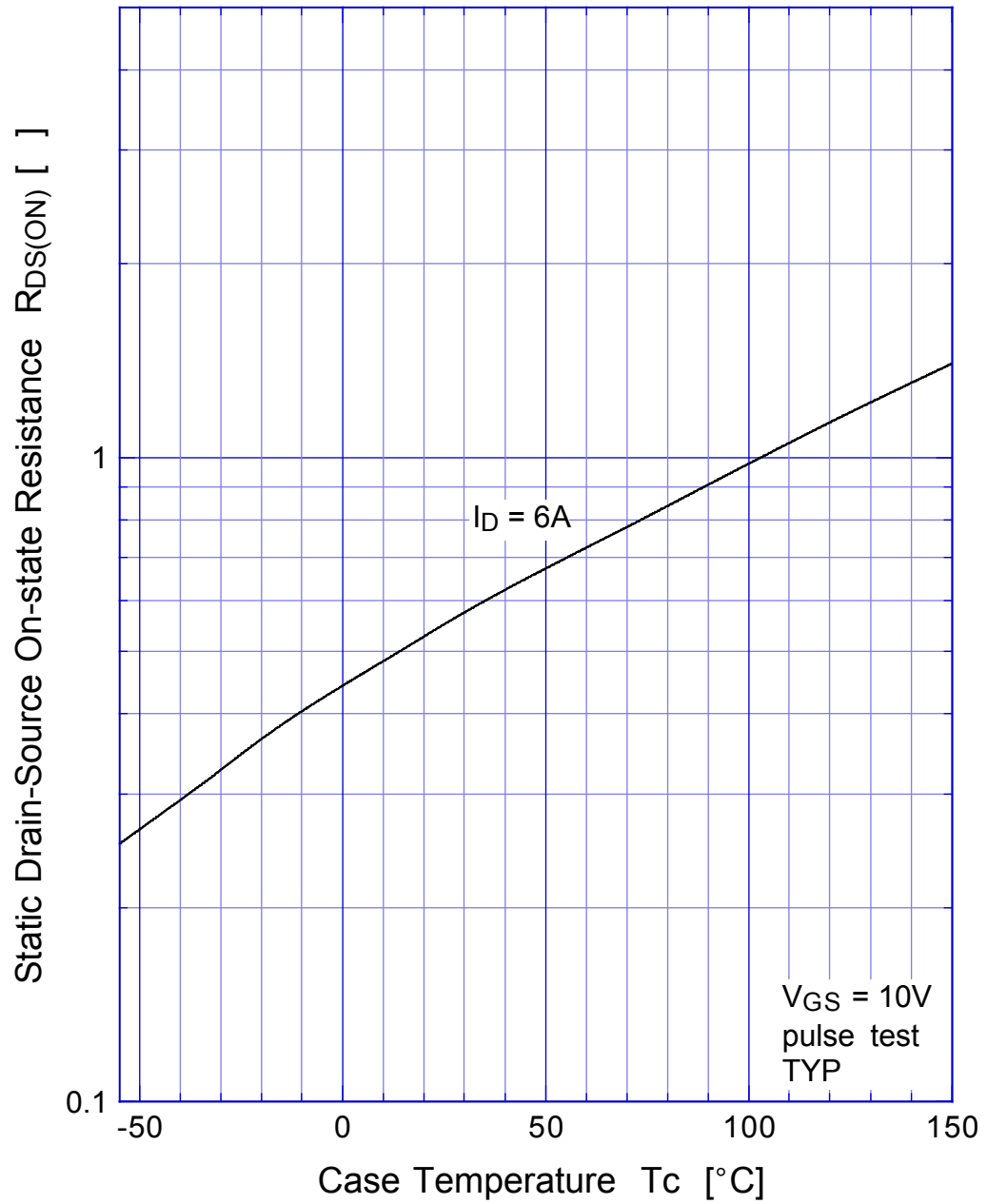

2SK2193 Gate Threshold Voltage

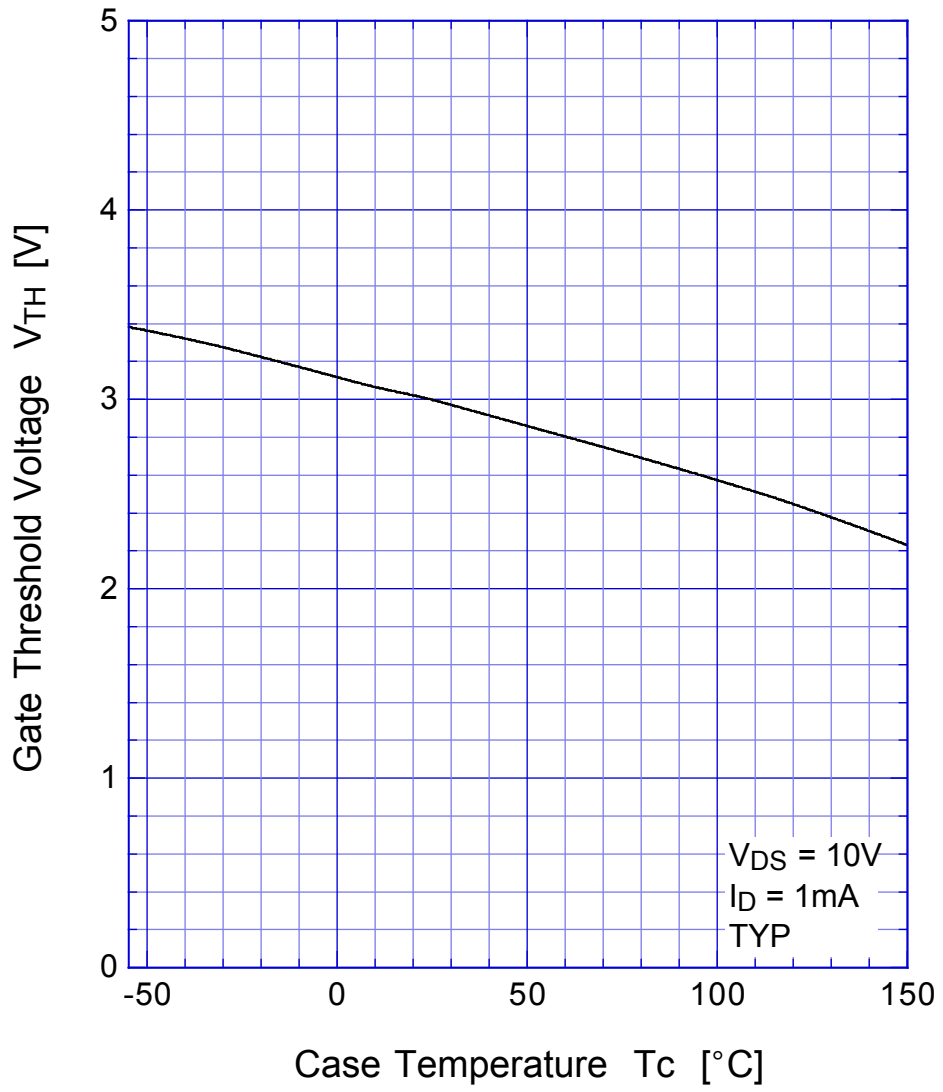

# 2SK2193 Safe Operating Area

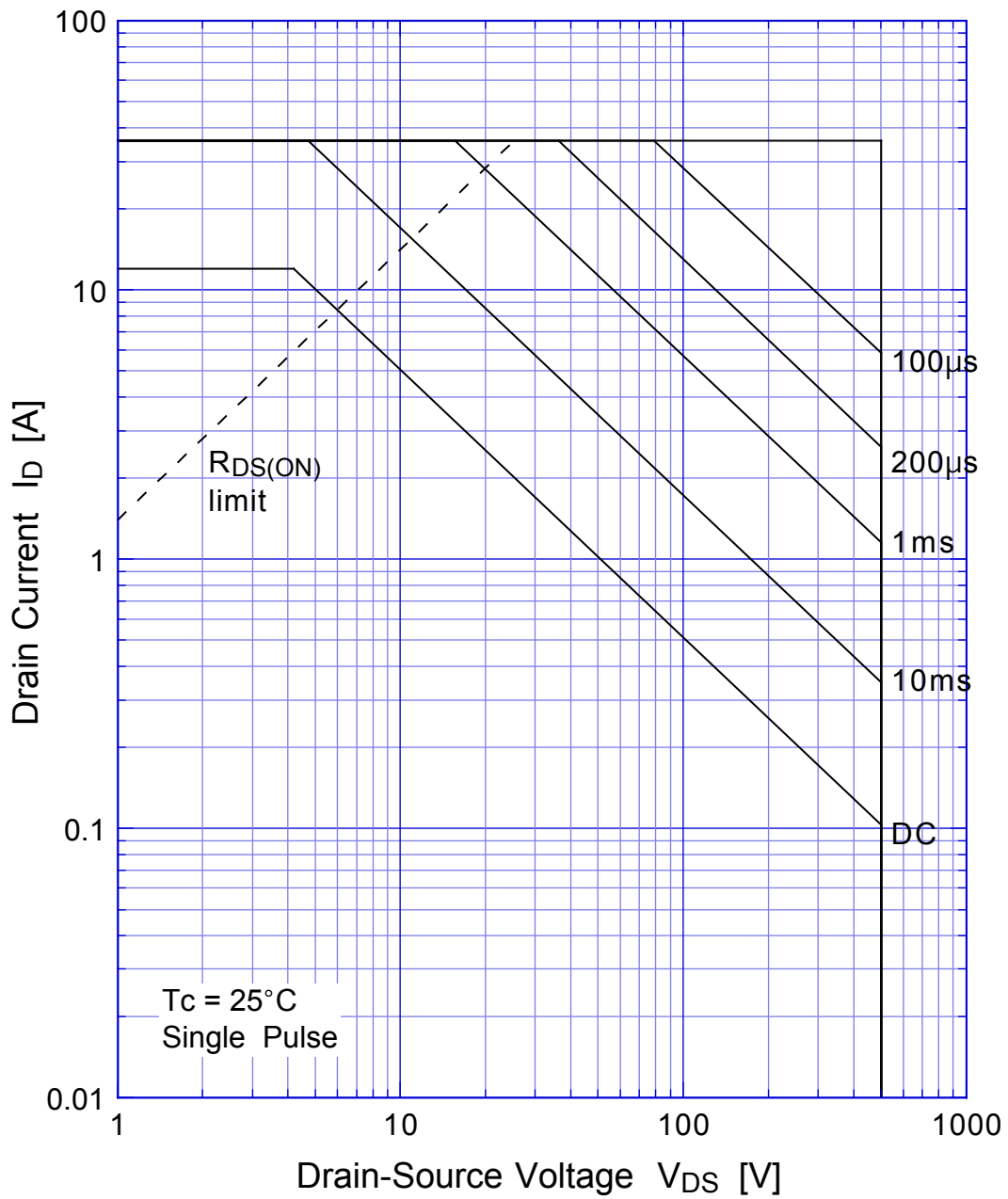

# 2SK2193 Transient Thermal Impedance

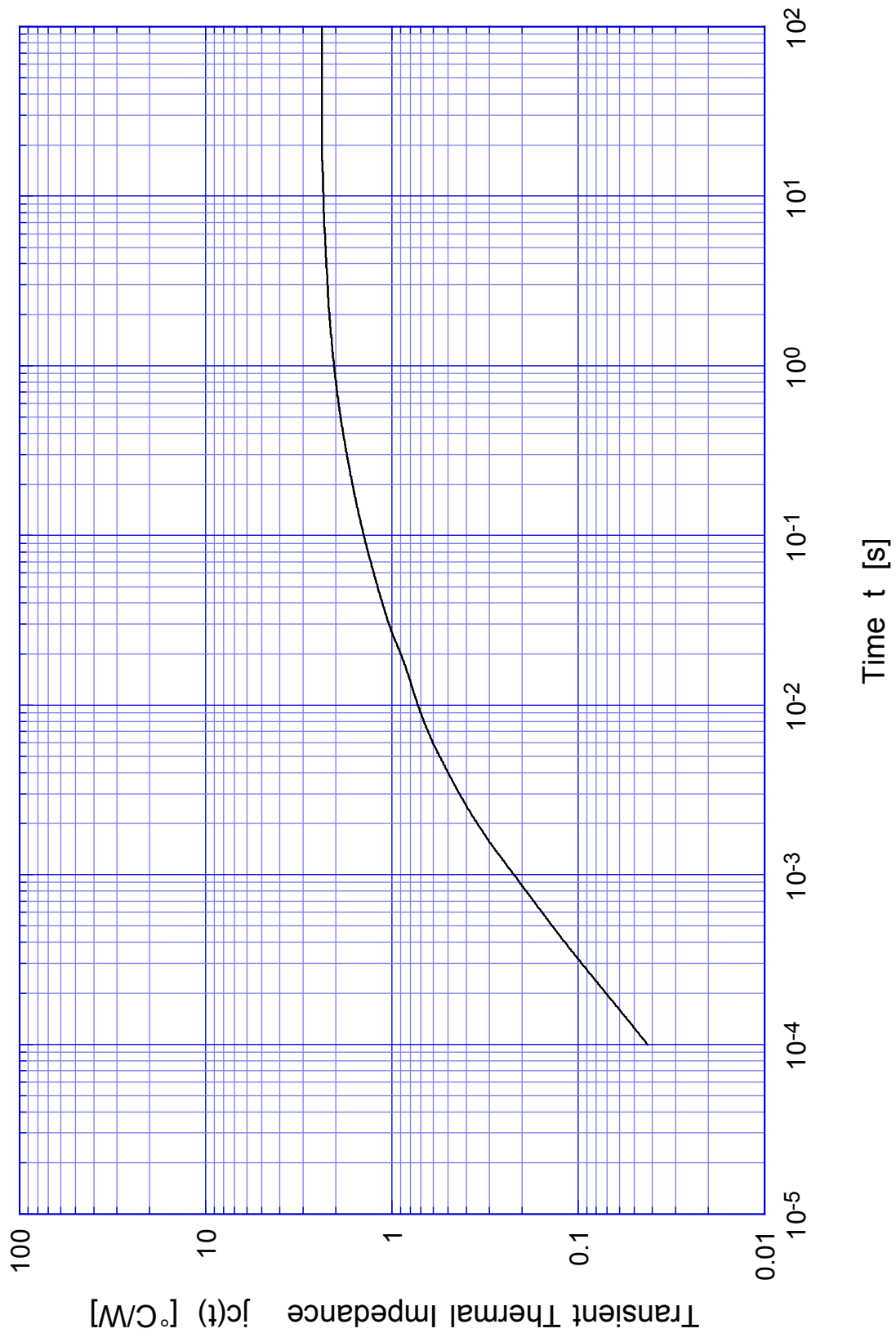

# 2SK2193

## Capacitance

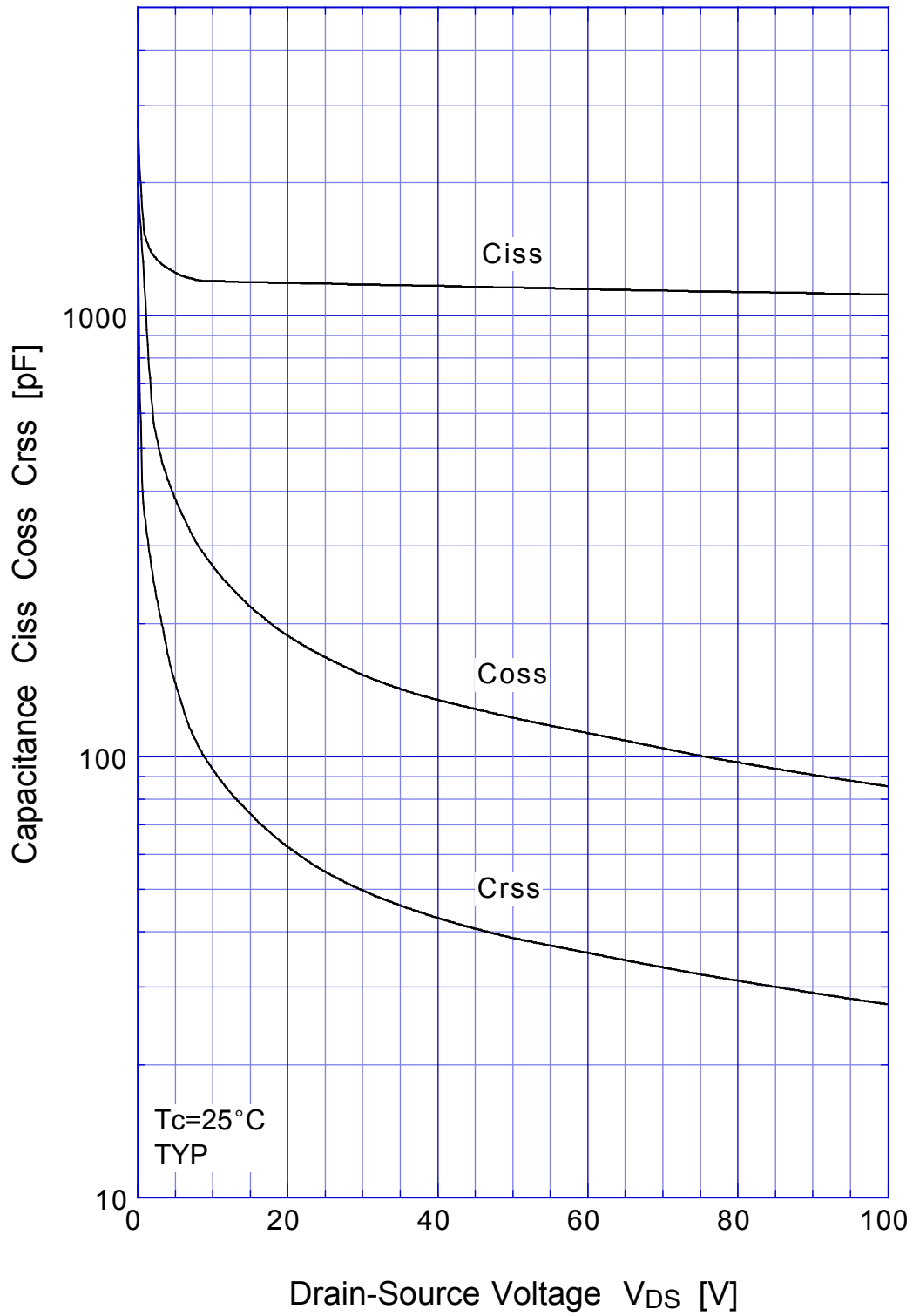



2SK2193

Power Derating



## 2SK2193 Gate Charge Characteristics

