

## 32M-BIT MASK-PROGRAMMABLE ROM

### 4M-WORD BY 8-BIT (BYTE MODE) / 2M-WORD BY 16-BIT (WORD MODE)

### PAGE ACCESS MODE

#### Description

The  $\mu$ PD23C32040L is a 33,554,432 bits mask-programmable ROM. The word organization is selectable (BYTE mode : 4,194,304 words by 8 bits, WORD mode : 2,097,152 words by 16 bits).

The active levels of OE (Output Enable Input) can be selected with mask-option.

The  $\mu$ PD23C32040L are packed in 44-pin plastic SOP, 48-pin plastic TSOP (I), and 44-pin plastic TSOP (II).

#### Features

- Word organization  
4,194,304 words by 8 bits (BYTE mode)  
2,097,152 words by 16 bits (WORD mode)
- Page access mode  
BYTE mode : 8 byte random page access  
WORD mode : 4 word random page access
- Operating supply voltage :  $V_{CC} = 3.3 \pm 0.3$  V

Operating supply voltage $V_{CC}$	Access time / Page access time ns (MAX.)	Power supply current (Active mode) mA (MAX.)	Standby current (CMOS level input) $\mu$ A (MAX.)
3.3 V $\pm$ 0.3 V	140 / 40	60	30

#### Ordering Information

Part number	Package
$\mu$ PD23C32040LGX-xxx	44-pin plastic SOP (600 mil)
$\mu$ PD23C32040LGY-xxx-MJH	48-pin plastic TSOP (I) (12 $\times$ 18 mm) (Normal bent)
$\mu$ PD23C32040LGY-xxx-MKH	48-pin plastic TSOP (I) (12 $\times$ 18 mm) (Reverse bent)
$\mu$ PD23C32040LG5-xxx-7JF	44-pin plastic TSOP (II) (400 mil) (Normal bent)

(xxx : ROM code suffix No.)

The information in this document is subject to change without notice.

**Pin Configuration (Marking Side)**

/xxx indicates active low signal.

**44-pin Plastic SOP (600 mil)**

[ μPD23C32040LGX ]

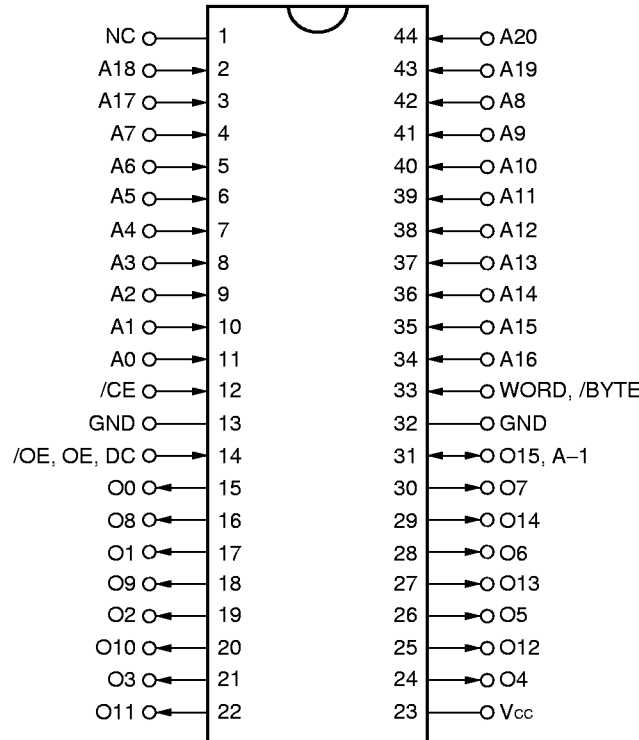

- A0 - A20 : Address inputs
- O0 - O7, O8 - O14 : Data Outputs
- O15, A-1 : Data 15 Output (WORD mode),  
LSB Address input (BYTE mode)
- WORD, /BYTE : Mode select
- /CE : Chip Enable
- /OE, OE : Output Enable
- Vcc : Supply Voltage
- GND : Ground
- NC <sup>Note 1</sup> : No Connection
- IC <sup>Note 2</sup> : Internal Connection
- DC : Don't Care

- Notes**
1. Some signals can be applied because this pin is not connected to the inside of the chip.
  2. Leave this pin unconnected or connect to GND.

48-pin Plastic TSOP (I) (12 × 18 mm) (Normal Bent)  
 [ μPD23C32040LGY-MJH ]



48-pin Plastic TSOP (I) (12 × 18 mm) (Reverse Bent)  
 [ μPD23C32040LGY-MKH ]



44-pin Plastic TSOP (II) (400 mil) (Normal Bent)

[ μPD23C32040LG5-7JF ]

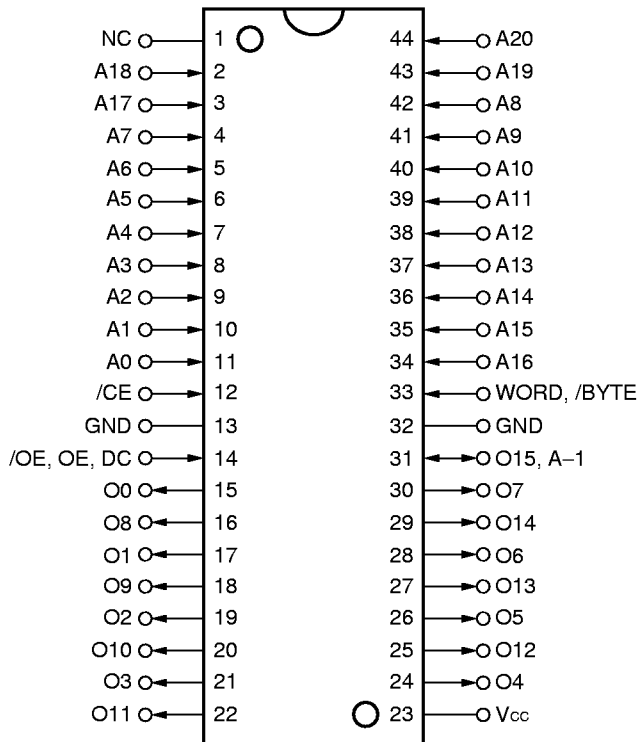

Input / Output Pin Functions

Pin name	Input / Output	Function
WORD, /BYTE	Input	The pin for switching WORD mode and BYTE mode. <b>High level</b> : WORD mode (2M-word by 16-bit) <b>Low level</b> : BYTE mode (4M-word by 8-bit)
A0 to A20 (Address input)	Input	Address bus. A0 to A20 are used differently in the WORD mode and the BYTE mode. <b>WORD mode (2M-word by 16-bit)</b> A0 to A20 are used as 21 bits address signals. <b>BYTE mode (4M-word by 8-bit)</b> A0 to A20 are used as the upper 21 bits of total 22 bits of address signal. (The least significant bit (A-1) is combined to O15.)
O0 to O7, O8 to O14 (Data output)	Output	Output data bus. O0 to O7, O8 to O14 are used differently in the WORD mode and the BYTE mode. <b>WORD mode (2M-word by 16-bit)</b> The lower 15 bits of 16 bits data outputs to O0 to O14. (The most significant bit (O15) combined to A-1.) <b>BYTE mode (4M-word by 8-bit)</b> 8 bits data outputs to O0 to O7 and also O8 to O14 are high impedance.
O15, A-1 (Data output 15, LSB address input)	Output, Input	O15, A-1 are used differently in the WORD mode and the BYTE mode. <b>WORD mode (2M-word by 16-bit)</b> The most significant output data bus (O15). <b>BYTE mode (4M-word by 8-bit)</b> The least significant address bus (A-1).
/CE (Chip Enable)	Input	Chip activating signal. When the OE is active, output states are following. <b>High level</b> : High impedance <b>Low level</b> : Data out
/OE, OE, DC (Output Enable, Don't Care)	Input	Output enable signal. The active level of OE is mask option. The active level of OE can be selected from high active, low active and Don't care at order.
Vcc	-	Supply voltage
GND	-	Ground
NC	-	Not internally connected (The signal can be connected).
IC	-	Internally connected (Leave this pin unconnected or connect to GND).

Block Diagram

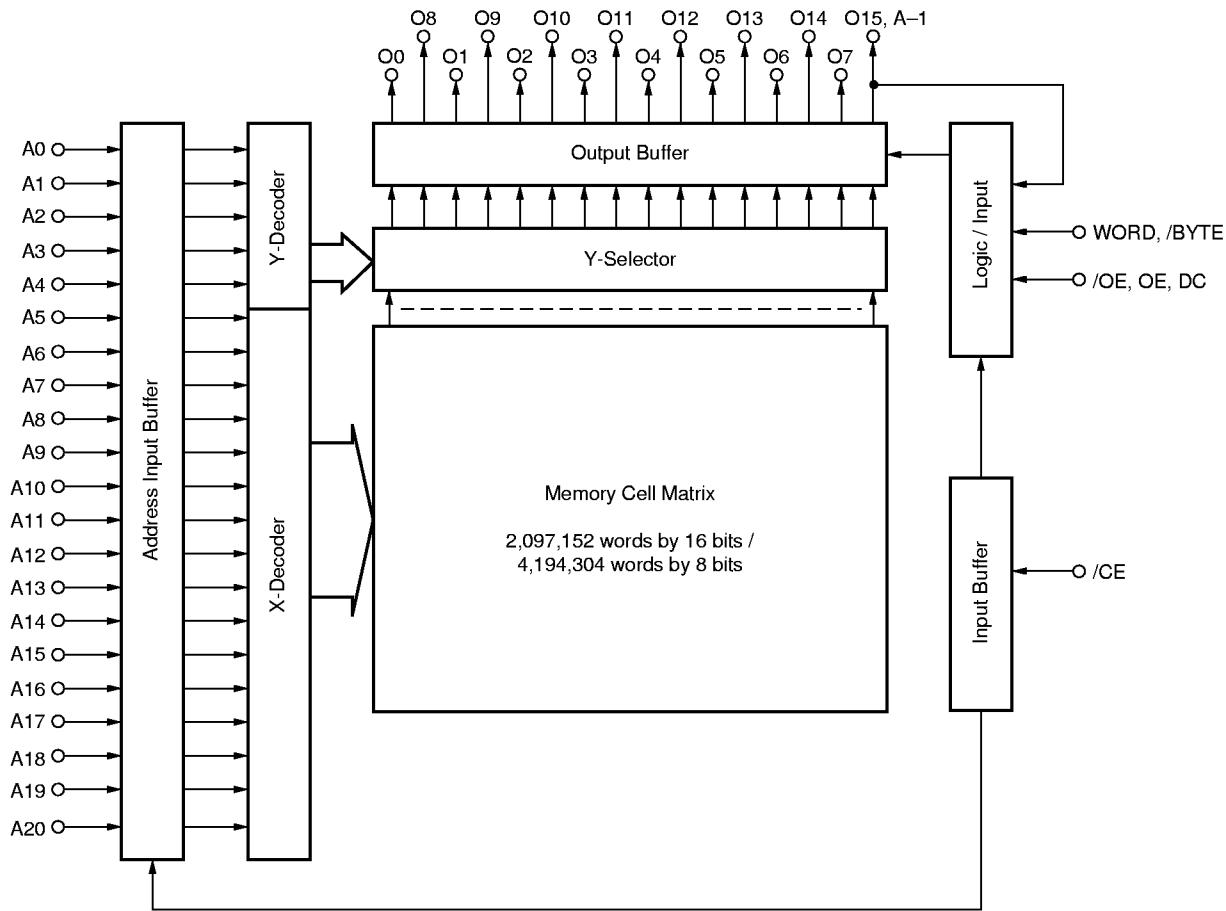

**Mask Option**

The active levels of output enable pin (/OE, OE, DC) are mask programmable and optional, and can be selected from among "0" "1" "x" shown in the table below.

Option	/OE, OE, DC	OE active level
0	/OE	L
1	OE	H
x	DC	Don't care

Operation modes for each option are shown in the tables below.

Operation mode (Option : 0)

/CE	/OE	Mode	Output state
L	L	Active	Data out
	H		High impedance
H	H or L	Standby	High impedance

Operation mode (Option : 1)

/CE	OE	Mode	Output state
L	L	Active	High impedance
	H		Data out
H	H or L	Standby	High impedance

Operation mode (Option : x)

/CE	DC	Mode	Output state
L	H or L	Active	Data out
H	H or L	Standby	High impedance

**Remark** L : Low level input  
 H : High level input

**Electrical Specifications**

**Absolute Maximum Ratings**

Parameter	Symbol	Condition	Rating	Unit
Supply voltage	V <sub>CC</sub>		-0.3 to +4.6	V
Input voltage	V <sub>I</sub>		-0.3 to V <sub>CC</sub> + 0.3	V
Output voltage	V <sub>O</sub>		-0.3 to V <sub>CC</sub> + 0.3	V
Operating ambient temperature	T <sub>A</sub>		-10 to +70	°C
Storage temperature	T <sub>stg</sub>		-65 to +150	°C

**Caution** Exposing the device to stress above those listed in Absolute Maximum Ratings could cause permanent damage. The device is not meant to be operated under conditions outside the limits described in the operational section of this specification. Exposure to Absolute Maximum Rating conditions for extended periods may affect device reliability.

**Capacitance (T<sub>A</sub> = 25 °C)**

Parameter	Symbol	Test condition	MIN.	TYP.	MAX.	Unit
Input capacitance	C <sub>I</sub>	f = 1 MHz			10	pF
Output capacitance	C <sub>O</sub>				12	pF

**DC Characteristics (T<sub>A</sub> = -10 to +70 °C, V<sub>CC</sub> = 3.3 V ± 0.3 V)**

Parameter	Symbol	Test condition	MIN.	TYP.	MAX.	Unit
High level input voltage	V <sub>IH</sub>		2.0		V <sub>CC</sub> + 0.3	V
Low level input voltage	V <sub>IL</sub>		-0.3		+0.8	V
High level output voltage	V <sub>OH</sub>	I <sub>OH</sub> = -100 μA	2.4			V
Low level output voltage	V <sub>OL</sub>	I <sub>OL</sub> = 2.1 mA			0.4	V
Input leakage current	I <sub>LI</sub>	V <sub>I</sub> = 0 V to V <sub>CC</sub>	-10		+10	μA
Output leakage current	I <sub>LO</sub>	V <sub>O</sub> = 0 V to V <sub>CC</sub> , Chip deselected	-10		+10	μA
Power supply current	I <sub>CC1</sub>	/CE = V <sub>IL</sub> (Active mode), I <sub>O</sub> = 0 mA			60	mA
Standby current	I <sub>CC3</sub>	/CE = V <sub>CC</sub> - 0.2 V (Standby mode)			30	μA



**AC Characteristics (TA = -10 to +70 °C, Vcc = 3.3 V ± 0.3 V)**

Parameter	Symbol	Test condition	MIN.	TYP.	MAX.	Unit
Address access time	t <sub>ACC</sub>				140	ns
Page access time	t <sub>PAC</sub>				40	ns
Chip enable access time	t <sub>CE</sub>				140	ns
Output enable access time	t <sub>OE</sub>				40	ns
Output hold time	t <sub>OH</sub>		0			ns
Output disable time	t <sub>DF</sub>		0		25	ns
WORD, /BYTE access time	t <sub>WB</sub>				140	ns

**Remark** t<sub>DF</sub> is the time from inactivation of /CE or /OE, OE to high-impedance state output.

**AC Test Conditions**

**Input Waveform (Rise / Fall Time ≤ 5 ns)**

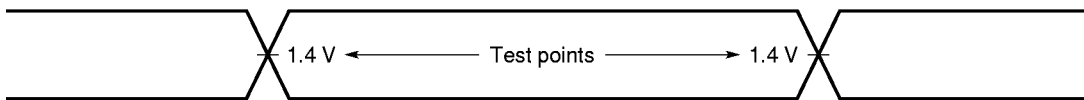

**Output Waveform**

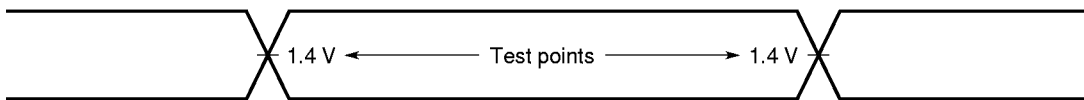

**Output Load**

1 TTL + 100 pF

Read Cycle Timing Chart 1

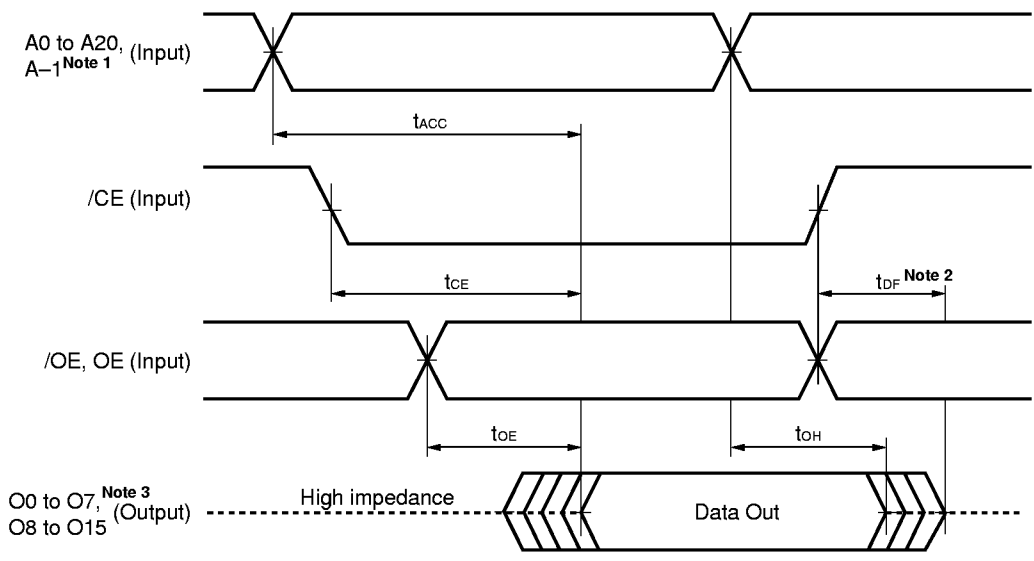

- Notes** 1. During WORD mode, A-1 is O15.
- 2.  $t_{DF}$  is specified when one of /CE, /OE, OE is inactivated.
- 3. During BYTE mode, O8 to O14 are high impedance and O15 is A-1.

Read Cycle Timing Chart 2 (Page Access Mode)

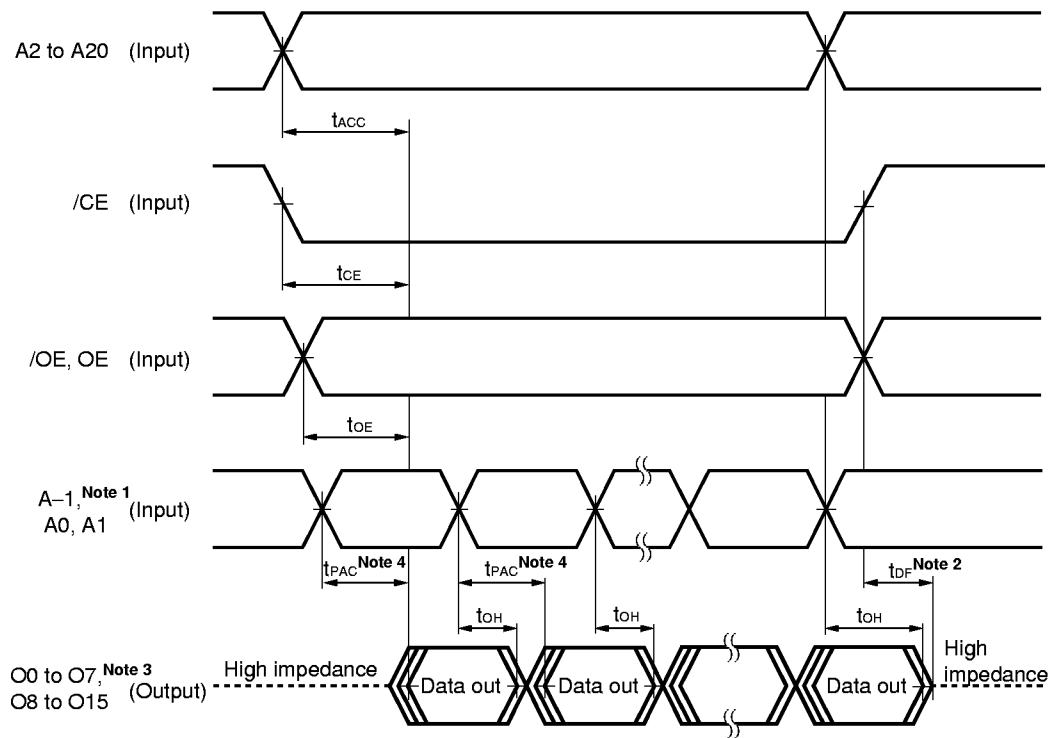

- Notes**
1. During WORD mode, A-1 is O15.
  2.  $t_{DF}$  is specified when one of /CE, /OE, OE is inactivated.
  3. During BYTE mode, O8 to O14 are high impedance and O15 is A-1.
  4. The definitions of page access time is as follows.

Page access time	Upper address (A2 to A20) inputs condition	/CE input condition	/OE, OE input condition
$t_{PAC}$	Before $t_{ACC} - t_{PAC}$	Before $t_{CE} - t_{PAC}$	Before stabilizing of page address (A-1, A0, A1)

WORD, /BYTE Switch Timing Chart

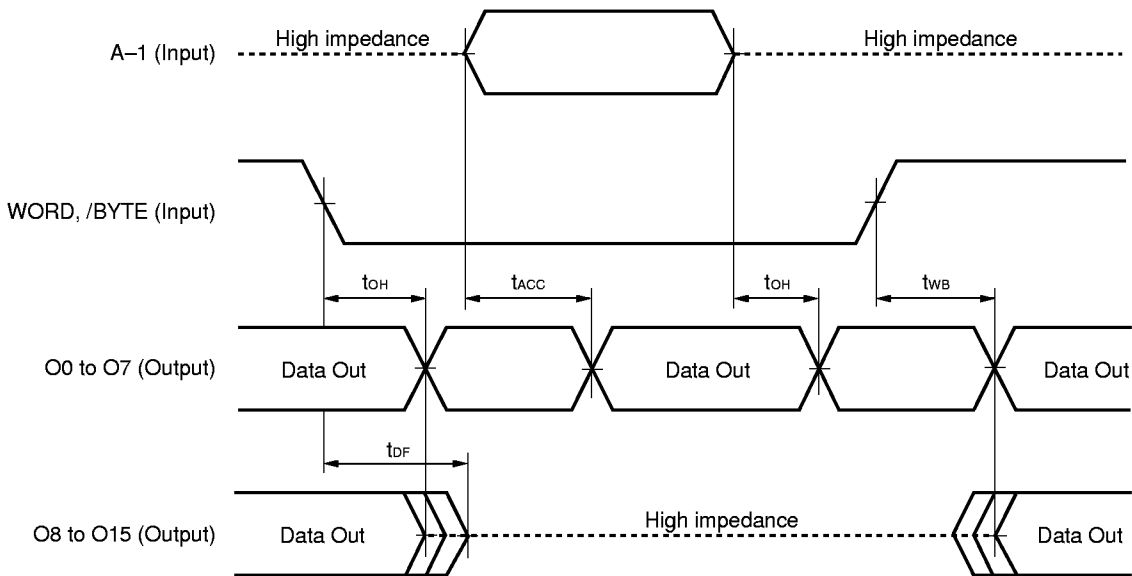

Remark /OE, OE and /CE : Active.

**Notice of Change in 48-Pin TSOP (I) Standoff Height**

We are changing the 48-pin TSOP (I) standoff height  $0.05 \pm 0.05$  mm (low standoff height) to  $0.1 \pm 0.05$  mm (high standoff height). Each lot version is identified by the fifth character of the lot number.

**Difference Between High Standoff Height and Low Standoff Height**

**Detail of Lead End**

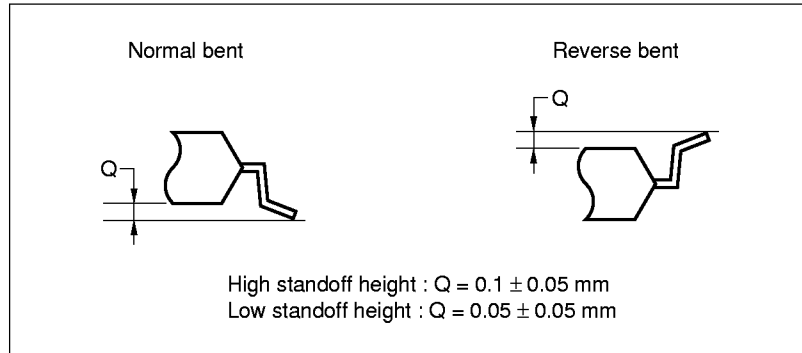

**Identification of Each Lot Version**

Each lot version is identified by the fifth character of the lot number.

Fifth character of the lot number	Lot version	Standoff height
L	L version	$0.1 \pm 0.05$ mm (high standoff height)
K	K version	$0.05 \pm 0.05$ mm (low standoff height)
E	E version	

**Marking Example**

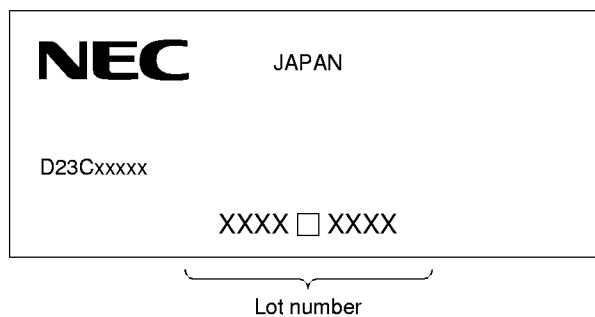

Package Drawings

44 PIN PLASTIC SOP (600 mil)

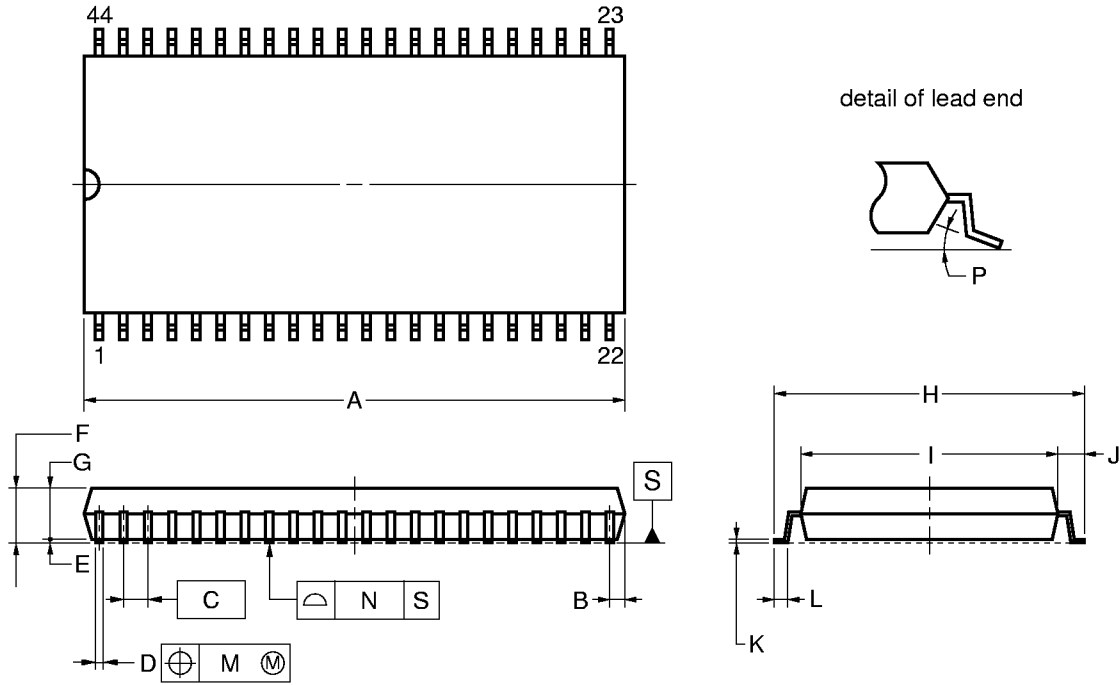

NOTE

1. Controlling dimension — millimeter.
2. Each lead centerline is located within 0.12 mm (0.005 inch) of its true position (T.P.) at maximum material condition.

ITEM	MILLIMETERS	INCHES
A	27.83 <sup>+0.4</sup> <sub>-0.05</sub>	1.096 <sup>+0.016</sup> <sub>-0.003</sub>
B	0.78 MAX.	0.031 MAX.
C	1.27 (T.P.)	0.050 (T.P.)
D	0.42 <sup>+0.08</sup> <sub>-0.07</sub>	0.017 <sup>+0.003</sup> <sub>-0.004</sub>
E	0.15±0.1	0.006±0.004
F	3.0 MAX.	0.119 MAX.
G	2.7±0.05	0.106 <sup>+0.003</sup> <sub>-0.002</sub>
H	16.04±0.3	0.631 <sup>+0.013</sup> <sub>-0.012</sub>
I	13.24±0.1	0.521 <sup>+0.005</sup> <sub>-0.004</sub>
J	1.4±0.2	0.055±0.008
K	0.22 <sup>+0.08</sup> <sub>-0.07</sub>	0.009 <sup>+0.003</sup> <sub>-0.004</sub>
L	0.8±0.2	0.031 <sup>+0.009</sup> <sub>-0.008</sub>
M	0.12	0.005
N	0.10	0.004
P	3° <sup>+7°</sup> <sub>-3°</sub>	3° <sup>+7°</sup> <sub>-3°</sub>

P44GX-50-600A-3

L Version : High Standoff Height

48 PIN PLASTIC TSOP (I) (12×18)

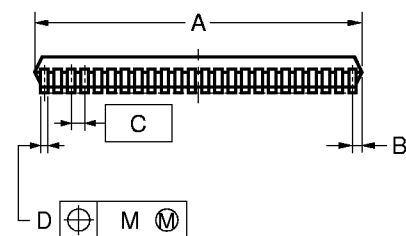
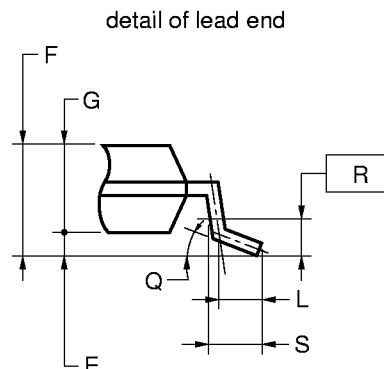
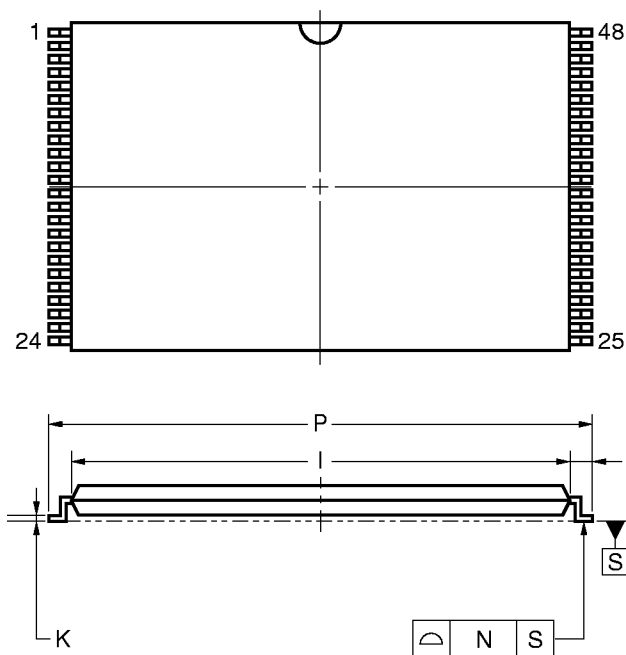

NOTES

1. Controlling dimension — Millimeter.
2. Each lead centerline is located within 0.10 mm (0.004 inch) of its true position (T.P.) at maximum material condition.
3. "A" excludes mold flash. (Includes mold flash : 12.4 mm MAX. <0.489 inch MAX.>)

ITEM	MILLIMETERS	INCHES
A	12.0±0.1	0.472 <sup>+0.005</sup> <sub>-0.004</sub>
B	0.45 MAX.	0.018 MAX.
C	0.5 (T.P.)	0.020 (T.P.)
D	0.22±0.05	0.009 <sup>+0.002</sup> <sub>-0.003</sub>
E	0.1±0.05	0.004±0.002
F	1.2 MAX.	0.048 MAX.
G	1.0±0.05	0.039 <sup>+0.003</sup> <sub>-0.002</sub>
I	16.4±0.1	0.646 <sup>+0.004</sup> <sub>-0.005</sub>
J	0.8±0.2	0.031 <sup>+0.009</sup> <sub>-0.008</sub>
K	0.145±0.05	0.006 <sup>+0.002</sup> <sub>-0.003</sub>
L	0.5	0.020
M	0.10	0.004
N	0.10	0.004
P	18.0±0.2	0.709 <sup>+0.008</sup> <sub>-0.009</sub>
Q	3° <sup>+5°</sup> <sub>-3°</sub>	3° <sup>+5°</sup> <sub>-3°</sub>
R	0.25	0.010
S	0.60±0.15	0.024 <sup>+0.006</sup> <sub>-0.007</sub>

S48GY-50-MJH1

L Version : High Standoff Height

48 PIN PLASTIC TSOP (I) (12×18)

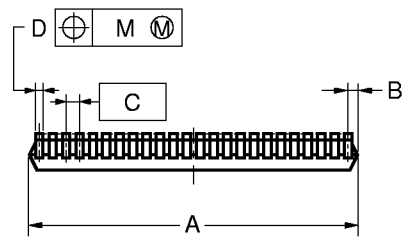
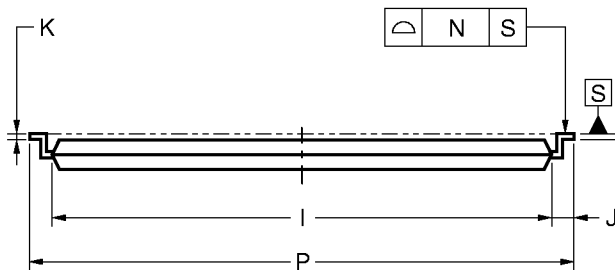
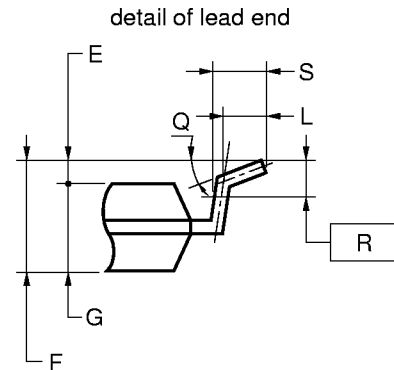
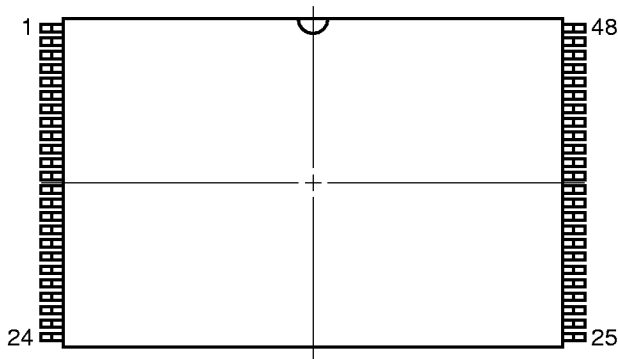

NOTES

1. Controlling dimension — Millimeter.
2. Each lead centerline is located within 0.10 mm (0.004 inch) of its true position (T.P.) at maximum material condition.
3. "A" excludes mold flash. (Includes mold flash : 12.4 mm MAX. <0.489 inch MAX.>)

ITEM	MILLIMETERS	INCHES
A	12.0±0.1	0.472 <sup>+0.005</sup> <sub>-0.004</sub>
B	0.45 MAX.	0.018 MAX.
C	0.5 (T.P.)	0.020 (T.P.)
D	0.22±0.05	0.009 <sup>+0.002</sup> <sub>-0.003</sub>
E	0.1±0.05	0.004±0.002
F	1.2 MAX.	0.048 MAX.
G	1.0±0.05	0.039 <sup>+0.003</sup> <sub>-0.002</sub>
I	16.4±0.1	0.646 <sup>+0.004</sup> <sub>-0.005</sub>
J	0.8±0.2	0.031 <sup>+0.009</sup> <sub>-0.008</sub>
K	0.145±0.05	0.006 <sup>+0.002</sup> <sub>-0.003</sub>
L	0.5	0.020
M	0.10	0.004
N	0.10	0.004
P	18.0±0.2	0.709 <sup>+0.008</sup> <sub>-0.009</sub>
Q	3° <sup>+5°</sup> <sub>-3°</sub>	3° <sup>+5°</sup> <sub>-3°</sub>
R	0.25	0.010
S	0.60±0.15	0.024 <sup>+0.006</sup> <sub>-0.007</sub>

S48GY-50-MKH1



K Version, E Version : Low Standoff Height

48 PIN PLASTIC TSOP (I) (12x18)

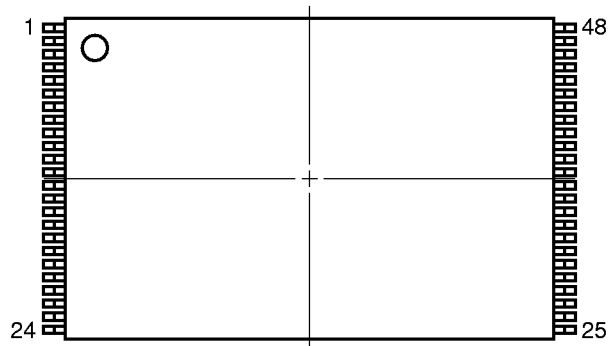

detail of lead end

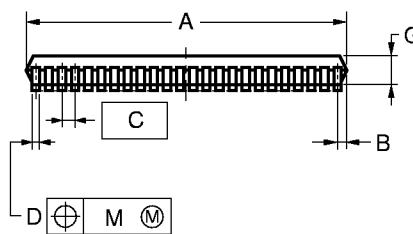
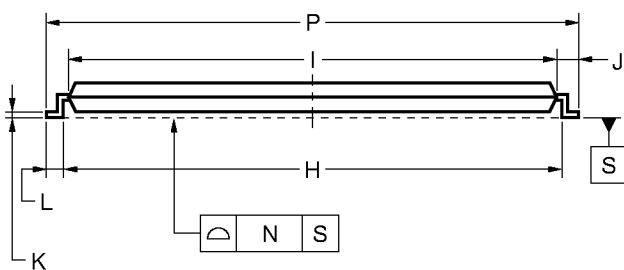
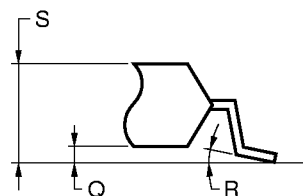

NOTES

- Controlling dimension — millimeter.
- Each lead centerline is located within 0.08 mm (0.003 inch) of its true position (T.P.) at maximum material condition.
- "A" excludes mold flash. (Includes mold flash : 12.4 mm MAX. <0.489 inch MAX.>)

ITEM	MILLIMETERS	INCHES
A	12.0±0.1	0.472 <sup>+0.005</sup> <sub>-0.004</sub>
B	0.45 MAX.	0.018 MAX.
C	0.5 (T.P.)	0.020 (T.P.)
D	0.22 <sup>+0.08</sup> <sub>-0.07</sub>	0.009 <sup>+0.003</sup> <sub>-0.004</sub>
G	0.97	0.038
H	17.0±0.2	0.669 <sup>+0.009</sup> <sub>-0.008</sub>
I	16.4±0.1	0.646 <sup>+0.004</sup> <sub>-0.005</sub>
J	0.8±0.2	0.031 <sup>+0.009</sup> <sub>-0.008</sub>
K	0.145 <sup>+0.03</sup> <sub>-0.055</sub>	0.006 <sup>+0.001</sup> <sub>-0.003</sub>
L	0.5±0.1	0.020 <sup>+0.004</sup> <sub>-0.005</sub>
M	0.08	0.003
N	0.10	0.004
P	18.0±0.2	0.709 <sup>+0.008</sup> <sub>-0.009</sub>
Q	0.05±0.05	0.002±0.002
R	2° <sup>+4°</sup> <sub>-2°</sub>	2° <sup>+4°</sup> <sub>-2°</sub>
S	1.02±0.08	0.040 <sup>+0.004</sup> <sub>-0.003</sub>

S48GY-50-MJH-3

K Version, E Version : Low Standoff Height

48 PIN PLASTIC TSOP (I) (12x18)

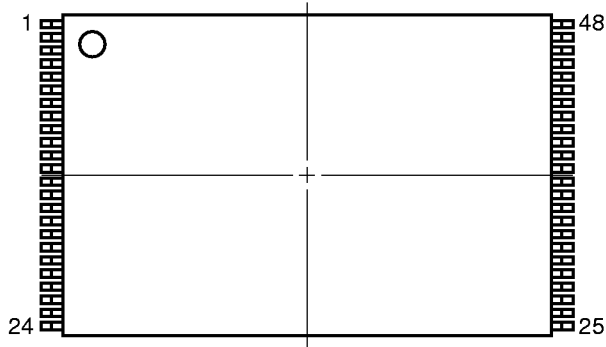

detail of lead end

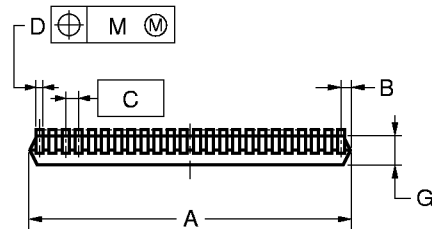
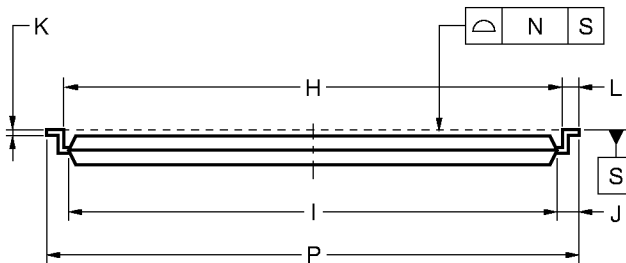
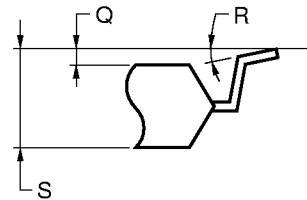

NOTES

1. Controlling dimension — millimeter.
2. Each lead centerline is located within 0.08 mm (0.003 inch) of its true position (T.P.) at maximum material condition.
3. "A" excludes mold flash. (Includes mold flash : 12.4 mm MAX. <0.489 inch MAX.>)

ITEM	MILLIMETERS	INCHES
A	12.0±0.1	0.472 <sup>+0.005</sup> <sub>-0.004</sub>
B	0.45 MAX.	0.018 MAX.
C	0.5 (T.P.)	0.020 (T.P.)
D	0.22 <sup>+0.08</sup> <sub>-0.07</sub>	0.009 <sup>+0.003</sup> <sub>-0.004</sub>
G	0.97	0.038
H	17.0±0.2	0.669 <sup>+0.009</sup> <sub>-0.008</sub>
I	16.4±0.1	0.646 <sup>+0.004</sup> <sub>-0.005</sub>
J	0.8±0.2	0.031 <sup>+0.009</sup> <sub>-0.008</sub>
K	0.145 <sup>+0.03</sup> <sub>-0.055</sub>	0.006 <sup>+0.001</sup> <sub>-0.003</sub>
L	0.5±0.1	0.020 <sup>+0.004</sup> <sub>-0.005</sub>
M	0.08	0.003
N	0.10	0.004
P	18.0±0.2	0.709 <sup>+0.008</sup> <sub>-0.009</sub>
Q	0.05±0.05	0.002±0.002
R	2° <sup>+4°</sup> <sub>-2°</sub>	2° <sup>+4°</sup> <sub>-2°</sub>
S	1.02±0.08	0.040 <sup>+0.004</sup> <sub>-0.003</sub>

S48GY-50-MKH-3

44 PIN PLASTIC TSOP(II) (400 mil)

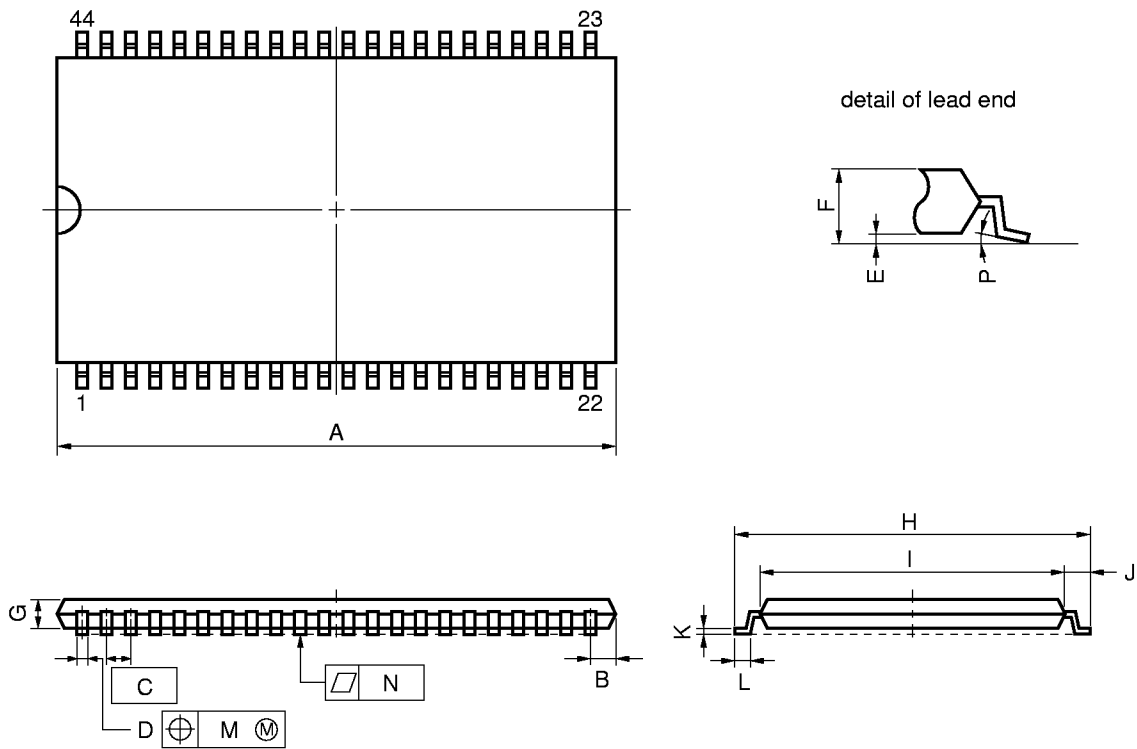

**NOTE**

Each lead centerline is located within 0.13 mm (0.005 inch) of its true position (T.P.) at maximum material condition.

ITEM	MILLIMETERS	INCHES
A	18.63 MAX.	0.734 MAX.
B	0.93 MAX.	0.037 MAX.
C	0.8 (T.P.)	0.031 (T.P.)
D	0.32 <sup>+0.08</sup> <sub>-0.07</sub>	0.013±0.003
E	0.1±0.05	0.004±0.002
F	1.2 MAX.	0.048 MAX.
G	0.97	0.038
H	11.76±0.2	0.463±0.008
I	10.16±0.1	0.400±0.004
J	0.8±0.2	0.031 <sup>+0.009</sup> <sub>-0.008</sub>
K	0.145 <sup>+0.025</sup> <sub>-0.015</sub>	0.006±0.001
L	0.5±0.1	0.020 <sup>+0.004</sup> <sub>-0.005</sub>
M	0.13	0.005
N	0.10	0.004
P	3 <sup>+7°</sup> <sub>-3°</sub>	3 <sup>+7°</sup> <sub>-3°</sub>

S44G5-80-7JF5

### Recommended Soldering Conditions

Please consult with our sales offices for soldering conditions of the  $\mu$ PD23C32040L.

### Types of Surface Mount Device

- $\mu$ PD23C32040LGX : 44-pin plastic SOP (600 mil)
- $\mu$ PD23C32040LGY-MJH : 48-pin plastic TSOP (I) (12 × 18 mm) (Normal Bent)
- $\mu$ PD23C32040LGY-MKH : 48-pin plastic TSOP (I) (12 × 18 mm) (Reverse Bent)
- $\mu$ PD23C32040LG5-7JF : 44-pin plastic TSOP (II) (400 mil) (Normal Bent)

[ MEMO ]

[ MEMO ]

## NOTES FOR CMOS DEVICES

### ① PRECAUTION AGAINST ESD FOR SEMICONDUCTORS

**Note:** Strong electric field, when exposed to a MOS device, can cause destruction of the gate oxide and ultimately degrade the device operation. Steps must be taken to stop generation of static electricity as much as possible, and quickly dissipate it once, when it has occurred. Environmental control must be adequate. When it is dry, humidifier should be used. It is recommended to avoid using insulators that easily build static electricity. Semiconductor devices must be stored and transported in an anti-static container, static shielding bag or conductive material. All test and measurement tools including work bench and floor should be grounded. The operator should be grounded using wrist strap. Semiconductor devices must not be touched with bare hands. Similar precautions need to be taken for PW boards with semiconductor devices on it.

### ② HANDLING OF UNUSED INPUT PINS FOR CMOS

**Note:** No connection for CMOS device inputs can be cause of malfunction. If no connection is provided to the input pins, it is possible that an internal input level may be generated due to noise, etc., hence causing malfunction. CMOS devices behave differently than Bipolar or NMOS devices. Input levels of CMOS devices must be fixed high or low by using a pull-up or pull-down circuitry. Each unused pin should be connected to  $V_{DD}$  or GND with a resistor, if it is considered to have a possibility of being an output pin. All handling related to the unused pins must be judged device by device and related specifications governing the devices.

### ③ STATUS BEFORE INITIALIZATION OF MOS DEVICES

**Note:** Power-on does not necessarily define initial status of MOS device. Production process of MOS does not define the initial operation status of the device. Immediately after the power source is turned ON, the devices with reset function have not yet been initialized. Hence, power-on does not guarantee out-pin levels, I/O settings or contents of registers. Device is not initialized until the reset signal is received. Reset operation must be executed immediately after power-on for devices having reset function.

[MEMO]

The export of this product from Japan is regulated by the Japanese government. To export this product may be prohibited without governmental license, the need for which must be judged by the customer. The export or re-export of this product from a country other than Japan may also be prohibited without a license from that country. Please call an NEC sales representative.

No part of this document may be copied or reproduced in any form or by any means without the prior written consent of NEC Corporation. NEC Corporation assumes no responsibility for any errors which may appear in this document.

NEC Corporation does not assume any liability for infringement of patents, copyrights or other intellectual property rights of third parties by or arising from use of a device described herein or any other liability arising from use of such device. No license, either express, implied or otherwise, is granted under any patents, copyrights or other intellectual property rights of NEC Corporation or others.

While NEC Corporation has been making continuous effort to enhance the reliability of its semiconductor devices, the possibility of defects cannot be eliminated entirely. To minimize risks of damage or injury to persons or property arising from a defect in an NEC semiconductor device, customers must incorporate sufficient safety measures in its design, such as redundancy, fire-containment, and anti-failure features.

NEC devices are classified into the following three quality grades:

"Standard", "Special", and "Specific". The Specific quality grade applies only to devices developed based on a customer designated "quality assurance program" for a specific application. The recommended applications of a device depend on its quality grade, as indicated below. Customers must check the quality grade of each device before using it in a particular application.

Standard: Computers, office equipment, communications equipment, test and measurement equipment, audio and visual equipment, home electronic appliances, machine tools, personal electronic equipment and industrial robots

Special: Transportation equipment (automobiles, trains, ships, etc.), traffic control systems, anti-disaster systems, anti-crime systems, safety equipment and medical equipment (not specifically designed for life support)

Specific: Aircrafts, aerospace equipment, submersible repeaters, nuclear reactor control systems, life support systems or medical equipment for life support, etc.

The quality grade of NEC devices is "Standard" unless otherwise specified in NEC's Data Sheets or Data Books. If customers intend to use NEC devices for applications other than those specified for Standard quality grade, they should contact an NEC sales representative in advance.

Anti-radioactive design is not implemented in this product.