

NAH Series

Small Package Solid State Acceleration Sensor

Low Level Output

APPLICATIONS

- Automotive: smart suspension, crash sensors, ABS, & air bag systems
- Vibration monitoring of machines
- Consumer appliances
- Earthquake monitoring
- Biomedical instruments
- Computer peripherals
- Military arming and fusing

FEATURES

- Range $\pm 2g$; $\pm 50g$
- Solid state, high reliability
- Low cost, miniature size
- Advanced silicon micromachined cantilever beam design
- Self-test feature included on $\pm 50g$ devices; 5g at 5 VDC and 50g at 12 VDC
- Output signal of up to 60mV FSO with 2.0mA excitation
- Integral micromachined stops yield superior shock resistance to 2000g
- On-chip integrated air damping eliminates high temperature sensitivity of fluid damping
- Temperature compensated from 0 to +70°C
- Resonant frequency greater than 500Hz (2g), 2500Hz (50g)
- Cross-axis sensitivity < 3% FSO
- Nonlinearity of < 0.25% FSO typical

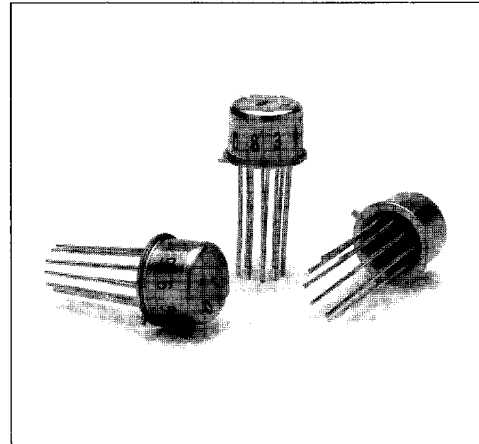

DESCRIPTION

Lucas NovaSensor's NAH Series piezoresistive accelerometer is housed in a standard TO-5 package that is suitable for printed circuit board mounting. It contains a unique, miniature cantilever-beam chip that produces a millivolt-level output that is linearly proportional to acceleration. A self-test feature is included on the $\pm 50g$ NAH Series accelerometers. As with all Lucas NovaSensor silicon sensors, the NAH Series accelerometer employs SenStable® processing technology, providing excellent output stability. Also, three-dimensional silicon sculpting and Silicon Fusion Bonding at the wafer level are used to achieve a smaller accelerometer chip with improved overall performance due to matched mechanical, chemical, electrical, and thermal properties.

Integral air damping and over-range protection up to 2000g in all 3 axes makes this miniature accelerometer suitable for a wide range of motion and vibration sensing applications. The extremely small size, high reliability, and ruggedness provide superior performance at low cost to the OEM user.

Specific resistor values are provided with each sensor for offset and temperature compensation, and the user may provide standard signal conditioning circuitry to amplify the output signal.

NAH Series

Small Package Solid State Acceleration Sensor — Low Level Output

T-65-13

OPERATING
CHARACTERISTICS

PARAMETER	VALUE	UNITS	NOTES					
GENERAL								
Acceleration Range	±2	g	0 ±2g					
	±50	g	0 ±50g					
Acceleration Limits	2000	g	any direction					
ELECTRICAL @ 2mA, 25°C (77°F) unless otherwise stated								
Input Excitation	2.0	mA	3.0mA max.					
Input Impedance	1300	Ω	±25%					
Output Impedance	2000	Ω	±25%					
Bridge Impedance	2000	Ω	±25%					
ENVIRONMENTAL								
Temperature Range								
Operating ⁽⁷⁾	-40 to +100	°C	-40° to +212°F					
Compensation	0 to +70	°C	+32° to +158°F					
MECHANICAL								
Weight	1	gram						
Case Material	10-pin TO-5 header, nickel and gold plated Kovar							
Performance⁽²⁾								
		Compensated⁽¹⁾						
		±2g			±50g			
Parameter	Units	Min.	Typ.	Max.	Min.	Typ.	Max.	Notes
Zero Acceleration Output	mV	-2	±1	2	-2	±1	2	
Sensitivity	mV/g	4	6	8	0.5	0.8	1.2	3
Nonlinearity	%FSO	-0.5	±0.25	0.5	-0.5	±0.25	0.5	4
Frequency Response	Hz	0-200			0-1000			
Mounted Resonant Frequency (undamped)	Hz	550			2500			
Damping Ratio		0.4	0.7	1.0	0.4	0.7	1.0	
Cross-axis Sensitivity	%FSO	-3	±1	3	-3	±1	3	
Thermal Accuracy of Offset	%FSO	±2			±2			
Thermal Accuracy of FSO	%FSO	±2			±2			
Thermal Hysteresis	%FSO	-0.5	±0.1	0.5	-0.5	±0.1	0.5	
Vibration Rectification	mg/g ²	±1.5			±0.15			5
Short-Term Stability of Offset	μV/V	±5			±5			6
Self-Test Output	g				4	5	6	8

- Notes:
1. All values for compensated bridge circuit. Compensation resistor values are supplied.
 2. All values measured in reference to 25°C and 2mA constant current, unless otherwise stated.
 3. Positive acceleration gives positive voltage; Negative acceleration gives negative voltage.
 4. Best fit straight line.
 5. Offset shift under constant AC vibration.
 6. Normalized offset/bridge voltage—100 hrs.
 7. Reduced performance outside compensation range.
 8. With 5VDC actuation voltage.

NAH Series

Small Package Solid State Acceleration Sensor — Low Level Output

T-65-13

TYPICAL PERFORMANCE CHARACTERISTICS

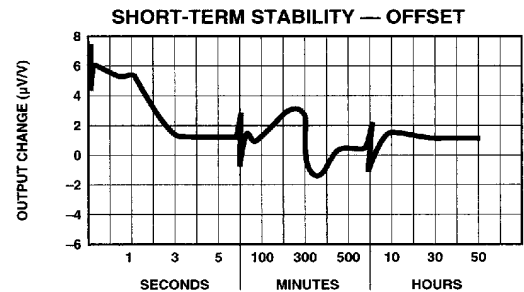
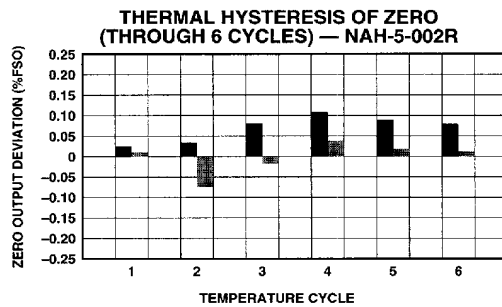
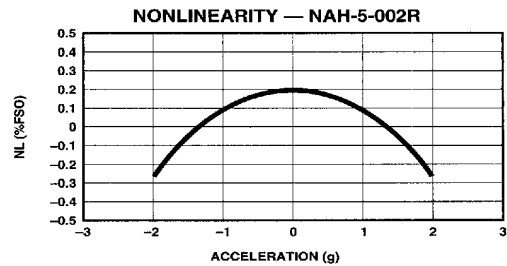
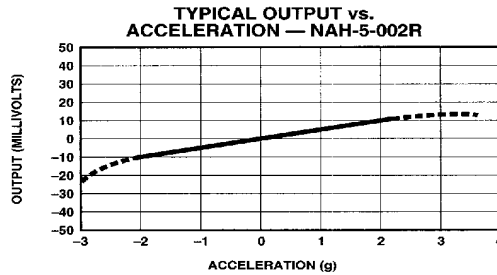
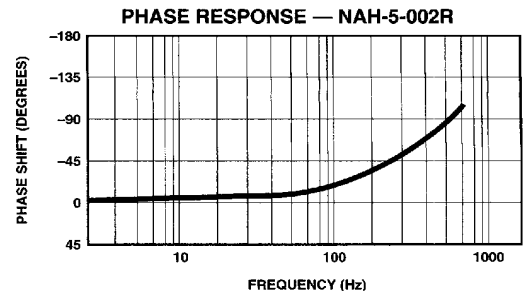
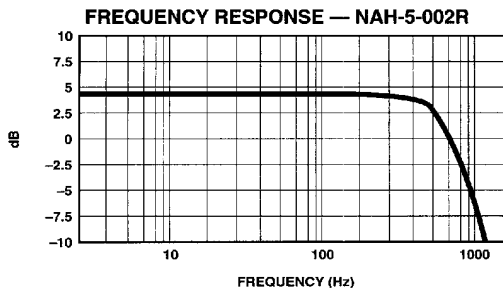

NOTE: Data taken at 25°C
TEMPERATURE CYCLE: 25°C, 70°C, 25°C, 0°C, 25°C

■ Room Temp. Hyst. after 70°C soak. ■ Room Temp. Hyst. after full cycle.

SCHEMATIC DIAGRAMS

±2g and ±50g

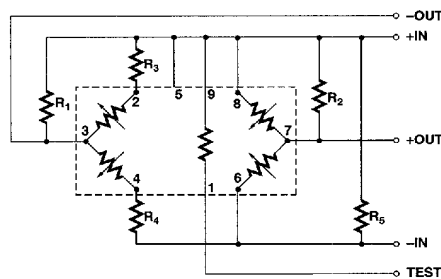

±50g Self-test Circuit Example

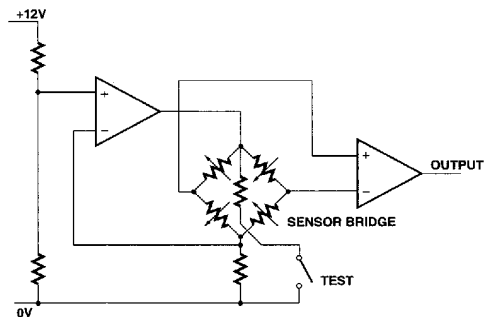

- Notes:**
1. Test voltage must be applied negative with respect to +IN.
 2. Test terminal pulled to 0V to actuate bridge. Should be held low 20 to 500mS for highest accuracy reading.
 3. Self-test feature available on ±50g range only; do not connect pins 1 and 9 when using ±2g version.

NAH Series

Small Package Solid State Acceleration Sensor — Low Level Output

PACKAGE DIAGRAMS

TO-5 PACKAGE

T-65-13

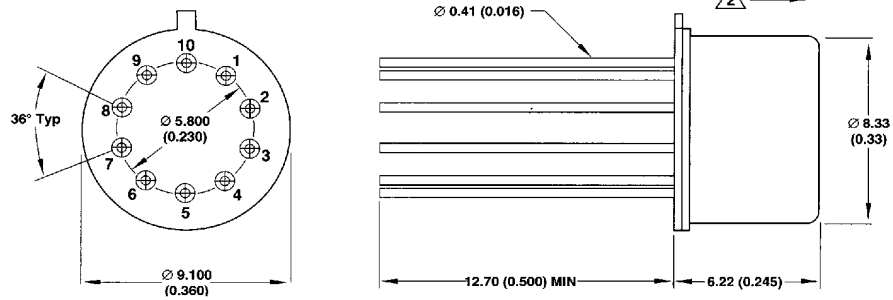

- Notes:**
1. All dimensions shown in mm(inches).
 2. Acceleration in this direction produces positive output.

ORDERING

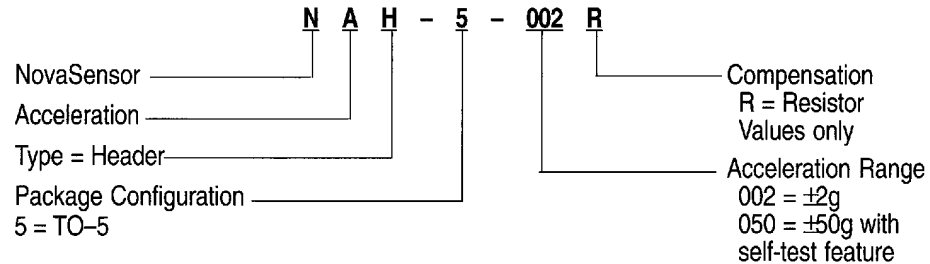

Sales Terms: Lucas NovaSensor standard sales terms apply. Prices and specifications are subject to change without notice.

Warranty: Lucas NovaSensor warrants its products against defects in material and workmanship for 12 months from date of shipment. Products not subjected to misuse will be repaired or replaced. THE FOREGOING IS IN LIEU OF ANY OTHER EXPRESSED OR IMPLIED WARRANTIES. Lucas NovaSensor reserves the right to make changes to any product herein and assumes no liability arising out of the application or use of any product or circuit described or referenced herein.

Lucas NovaSensor
1055 Mission Court
Fremont, CA 94539



Telephone: 510-490-9100
Fax: 510-770-0645
Telex: 990010

Rev.1192