

Stereo 1.5W Audio Power Amplifier with DC Volume Control

Features

- Operating Voltage: 3.3V to 5V
- DC Volume Control Interface, 0dB to -105dB
- Depop Circuitry Integrated
- Thermal shutdown protection circuitry
- High supply voltage ripple rejection
- Low Supply Current, $I_{DD} = 13\text{mA}$ at Stereo BTL
- Low Shutdown Current, $I_{DD} = 0.7\mu\text{A}$
- Bridge-Tied Load (BTL) or Single-Ended-(SE) Modes Operation
- Output Power at 1% THD+N, $V_{DD}=5\text{V}$
-1.2 W/Ch (typ) into an 8Ω Load
- Output Power at 10% THD+N, $V_{DD}=5\text{V}$
-1.5 W/Ch (typ) into an 8Ω Load
- Low Crossover Distortion
- Low Quiescent Current
- Bridge-tied or Stereo(Single-ended) Configurations

General Description

The APA7063 is a monolithic integrated circuit that provides DC volume control, and a stereo bridged audio power amplifiers capable of producing 1.5W(1.2W) into 8Ω with less than 10%(1.0%) THD+N. APA7063 provides a volume control pin DC_Vol determines the attenuation of output of the amplifiers. The attenuator range is from 0dB ($\text{DC_Vol}=0.7V_{DD}$) to -105dB ($\text{DC_Vol}=0\text{V}$) with 32 steps. Both of the depop circuitry and the thermal shutdown protection circuitry are integrated in the APA7063, that reduces pops and clicks noise during power up and when using the shutdown modes and protects the chip from being destroyed by over temperature failure. To simplify the audio system design applications, the APA7063 combines a stereo bridge-tied loads (BTL) mode for speaker drive and a stereo single-end (SE) mode for headphone drive into a single chip, where both modes are easily switched by the SE/BTL input control pin signal. The APA7063 also features a shutdown function which keeps the supply current only $0.7\mu\text{A}$ (typ).

Applications

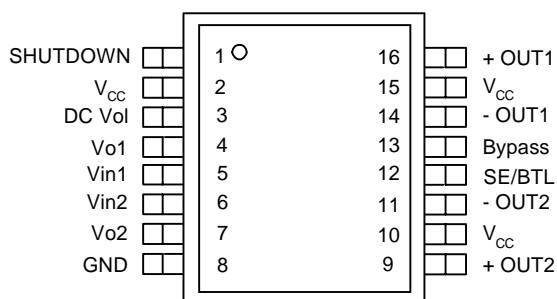

- Portable and Desktop Computers
- Multimedia Monitors
- Portable Radios, PDAs, and Portable TVs

Pin Description



ANPEC reserves the right to make changes to improve reliability or manufacturability without notice, and advise customers to obtain the latest version of relevant information to verify before placing orders.

Ordering and Marking Information

<p>APA7063 □□-□□</p> <p> □□ — Handling Code □□ — Temp. Range □□ — Package Code </p>	<p>Package Code J : PDIP - 16 K : SOP - 16 Temp. Range I : - 40 to 85 °C Handling Code TU : Tube TR : Tape & Reel </p>
<p>APA7063 J :</p> <div style="border: 1px solid black; padding: 2px; display: inline-block;">  </div>	<p>XXXXX - Date Code</p>
<p>APA7063 K :</p> <div style="border: 1px solid black; padding: 2px; display: inline-block;">  </div>	<p>XXXXX - Date Code</p>

Block Diagram

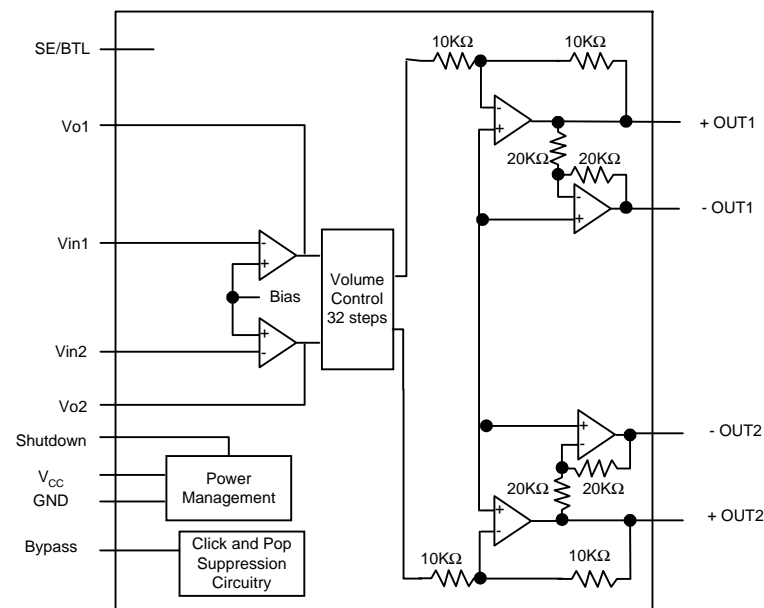

Absolute Maximum Ratings

(Over operating free-air temperature range unless otherwise noted.)

Symbol	Parameter	Rating	Unit
V _{DD}	Supply Voltage	6	V
T _A	Operating Ambient Temperature Range	-40 to 85	°C
T _J	Maximum Junction Temperature	150	°C
T _{STG}	Storage Temperature Range	-65 to +150	°C
T _S	Soldering Temperature, 10 seconds	260	°C
V _{ESD}	Electrostatic Discharge	-2000 to 2000*1	V

Electical Characteristics

Electrical Characteristics for Entire IC

The following specifications apply for $V_{DD}=5V$ unless otherwise noted. Limits apply for $T_A=25^{\circ}C$

Symbol	Parameter	Test Conditions	APA7063			Unit
			Min.	Typ.	Max.	
V_{DD}	Supply Voltage		3.3		5.5	V
I_{DD}	Quiescent Power Supply Current	$V_{IN}=0V, I_O=0A$		13	25	mA
I_{SD}	Shutdown Current	$V_{PIN2}=V_{DD}$		0.7	2.0	μA
V_{IH}	SE/BTL High Input Voltage		4			V
V_{IL}	SE/BTL Low Input Voltage				0.8	V

Electrical Characteristics for Volume Attenuators

The following specifications apply for $V_{DD}=5V$. Limits apply for $T_A=25^{\circ}C$

Symbol	Parameter	Test Conditions	APA7063			Unit
			Min.	Typ.	Max.	
C_{RANGE}	Attenuator Range	Gain with $V_{PIN3}=5V$			± 0.5	dB
		Attenuation with $V_{PIN3}=0V$	-100	-105		

Electrical Characteristics for BTL Mode Operation

The following specifications apply for $V_{DD}=5V$ unless otherwise noted. Limits apply for $T_A=25^{\circ}C$

Symbol	Parameter	Test Conditions	APA7063	Unit
			Typ.	
V_{OS}	Output Offset Voltage	$V_{IN}=0V$	5	mV
P_O	Output Power	THD=1%, $f=1kHz$ $R_L=8\Omega$	1.2	W
		THD=10%, $f=1kHz$ $R_L=8\Omega$	1.5	
THD+N	Total Harmonic Distortion + Noise	$A_{VD}=2, 20Hz < f < 20kHz, R_L=8\Omega, P_O=1W$ $P_O=340mW, R_L=32\Omega,$	0.3 1.0	%
RSRR	Power Supply Rejection Ratio	$V_{RIPPLE}=200mV_{RMS}, R_L=8\Omega$ $C_B=2.2\mu F, f=120Hz$	74	dB
X_{TALK}	Channel Separation	$f=1kHz, C_B=2.2\mu F$	95	dB
V_N	Output Noise Voltage	$R_L=8\Omega, A-Wtd$ Filter	40	μV

Electical Characteristics (Cont.)

Electrical Characteristics for SE Mode Operation

The following specifications apply for $V_{DD} = 5V$ unless otherwise noted. Limits apply for $T_A = 25^\circ C$

Symbol	Parameter	Test Conditions	APA7063	Unit
			Typ.	
V_{DS}	Output Offset Voltage	$V_{IN}=0V,$	100	mV
P_O	Output Power	THD=1%, $f=1KHZ, R_L=32K\Omega$ THD=10%, $f=1KHZ, R_L=32K\Omega$	95 100	mW
THD+N	Total Harmonic Distortion plus Noise	$A_V=1, V_{OUT}=1 V_{RMS}, f=1KHZ, R_L=1K\Omega$	0.01	%
		$P_O=75mW, R_L=32K\Omega, A_V=1, f=1KHZ$	0.05	%
RSRR	Power Supply Rejection Ratio	$V_{RIPPLE}=200mV_{RMS}, f=120Hz, C_B=2.2\mu F$	58	dB
X_{TALK}	Channel Separation	$f=1KHZ, C_B=2.2\mu F$	95	dB
V_N	Output Noise Voltage	$R_L=1K\Omega, A-Wtd$ Filter	30	μV

Pin Description

Pin Name	No	I/O	Description
Shutdown	1	I	Shutdown mode control signal input, place entire IC in shutdown mode when held high, $I_{dd}=0.7\mu A$.
VDD	2,10,15		Supply voltage input pin.
DC_Vol	3	I	Volume control function input pin.
Vo1	4	O	Channel 1 output for external feedback circuit.
Vin1	5	I	Audio input channel 1
Vin2	6	I	Audio input channel 2
Vo2	7	O	Channel 2 output for external feedback circuit.
GND	8		Ground connection for circuitry.
+OUT2	9	O	Channel 2 positive output in BTL mode and high impedance state in SE mode.
-OUT2	11	O	Channel 2 negative output in BTL mode and in SE mode.
SE/BTL	12	I	Mode control signal input, hold low for BTL mode, hold high for SE mode.
Bypass	13	I	Connect to voltage divider for internal mid_supply bias
-OUT1	14	O	Channel 1 negative output in BTL mode and in SE mode.
+OUT1	16	O	Channel 1 positive output in BTL mode and high impedance state in SE mode.

Typical Application Circuit

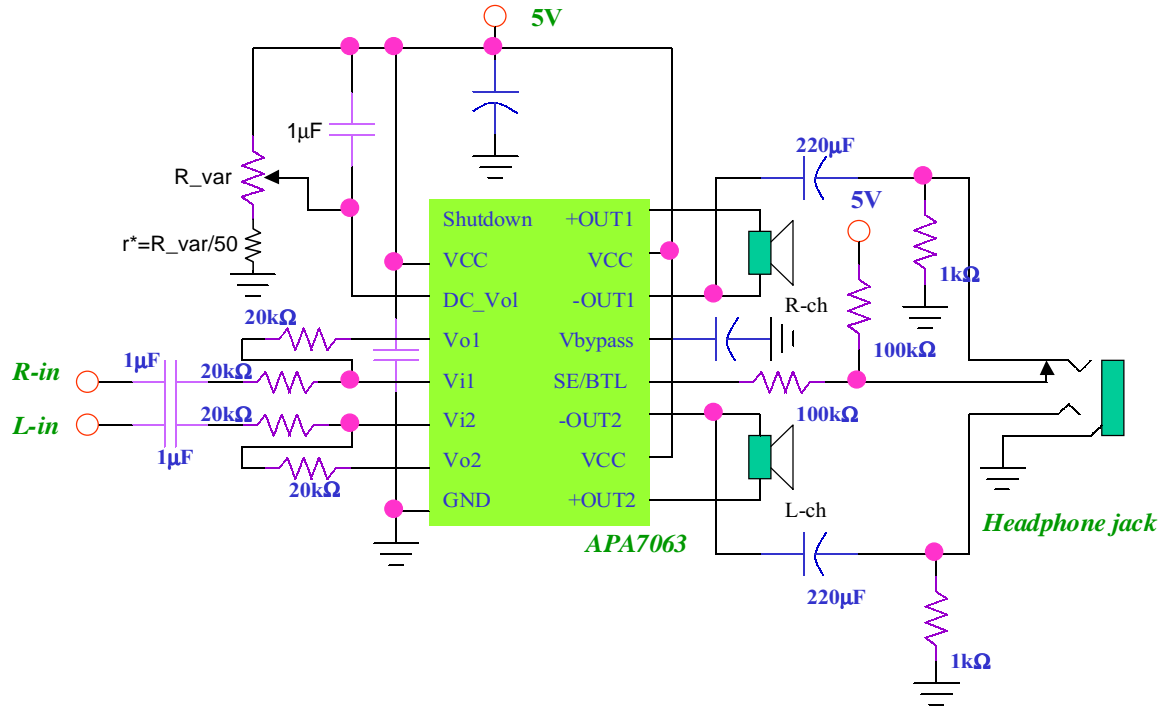

* Add a resistor to avoid volume control gain error at power on status. For the R_var with 10KΩ variable resistor, the recommended value of r is in range of 100~200Ω.

Typical Characteristics

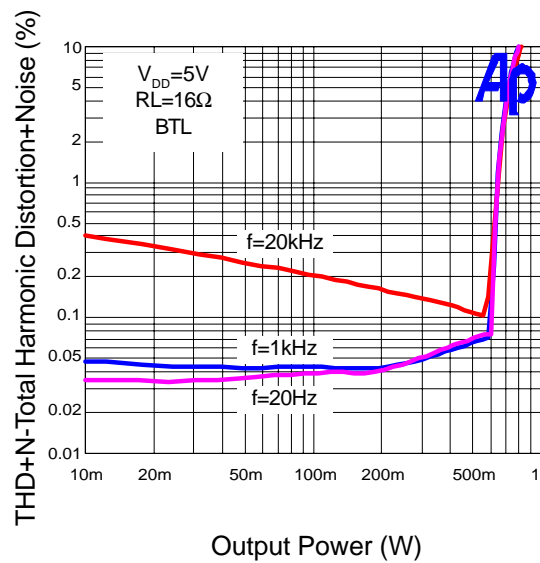
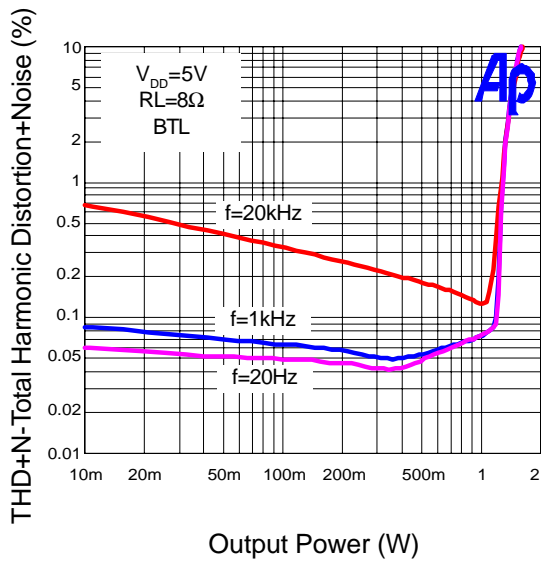
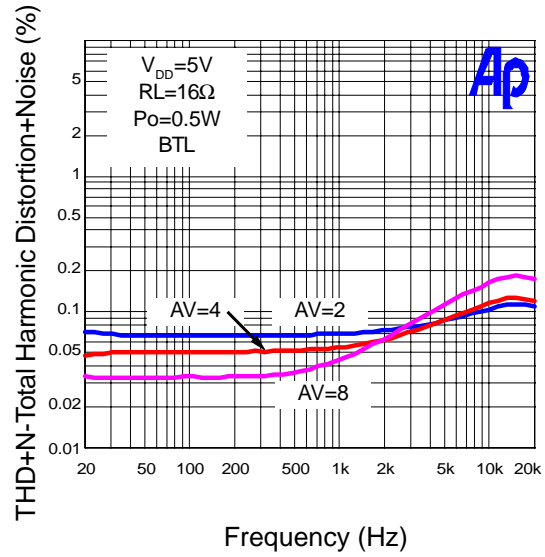
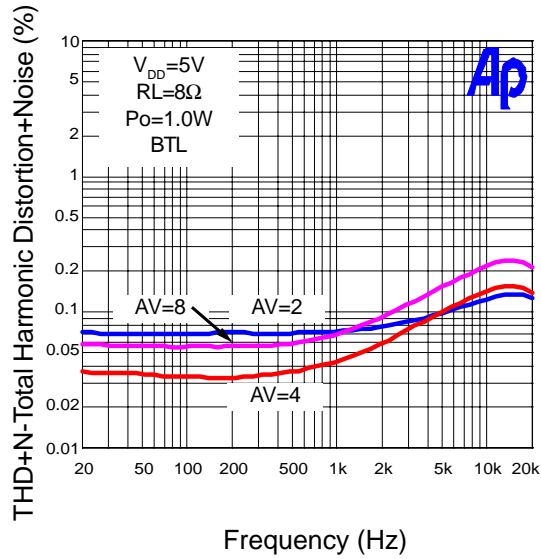

Typical Characteristics (Cont.)

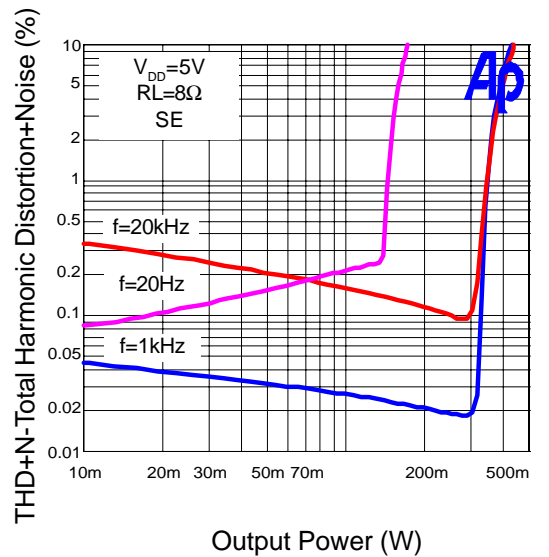
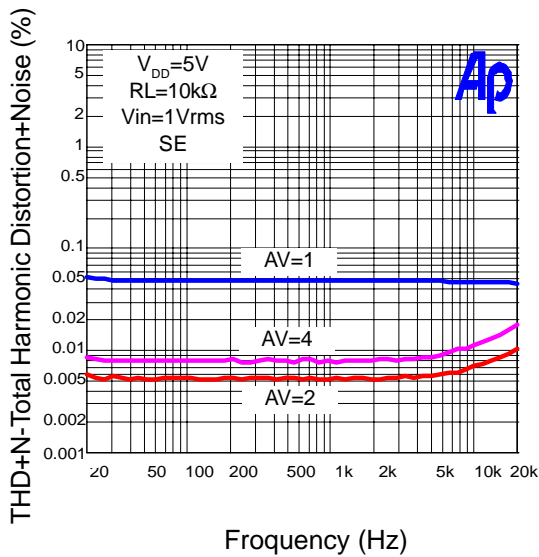
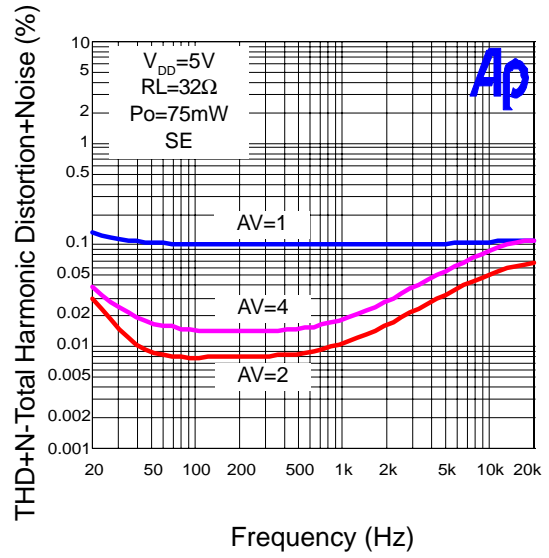
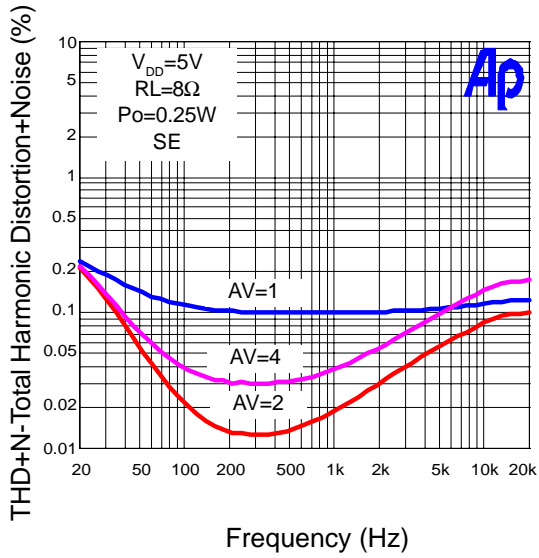

Typical Characteristics (Cont.)

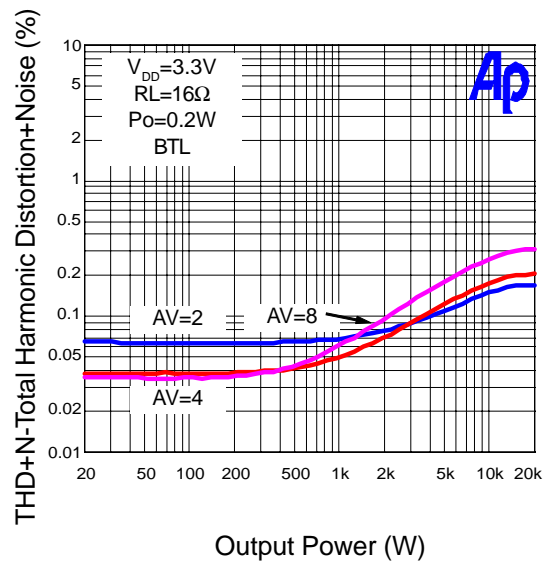
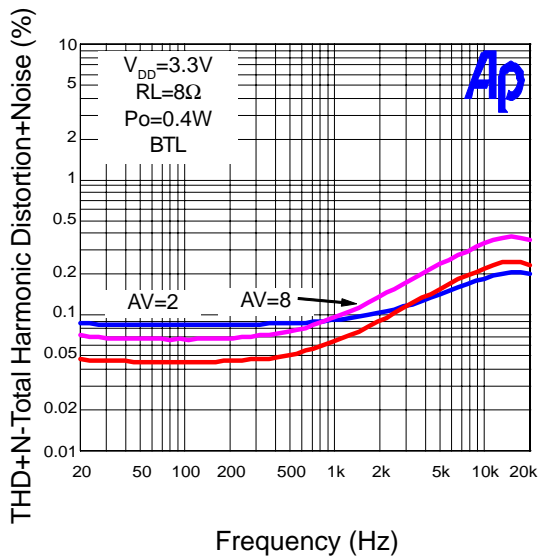
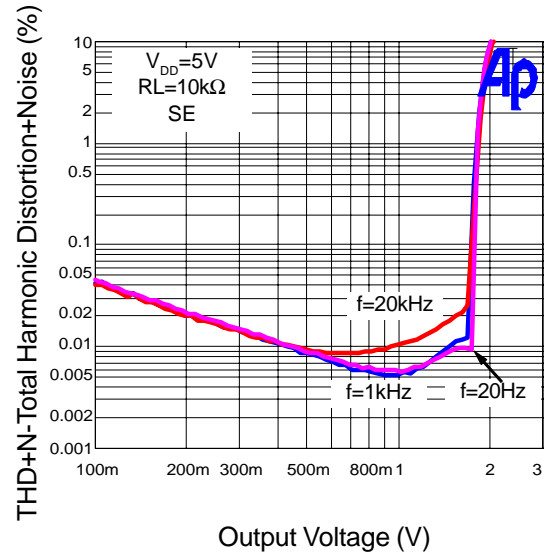
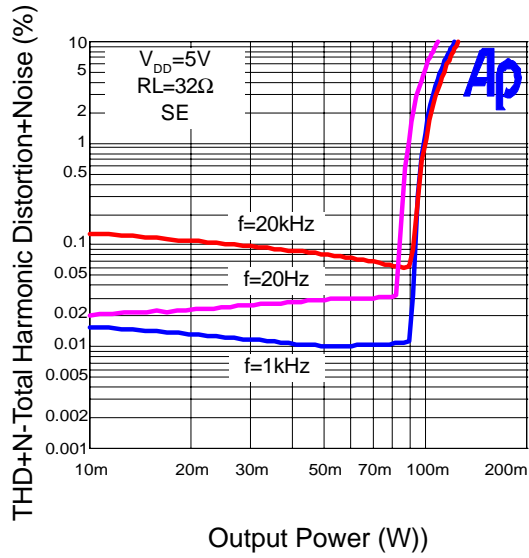

Typical Characteristics (Cont.)

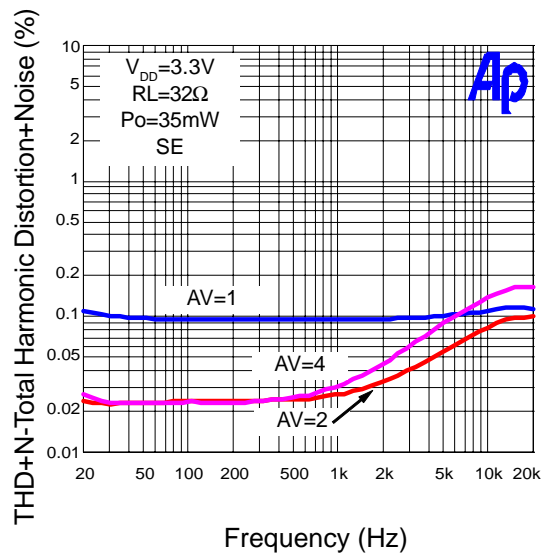
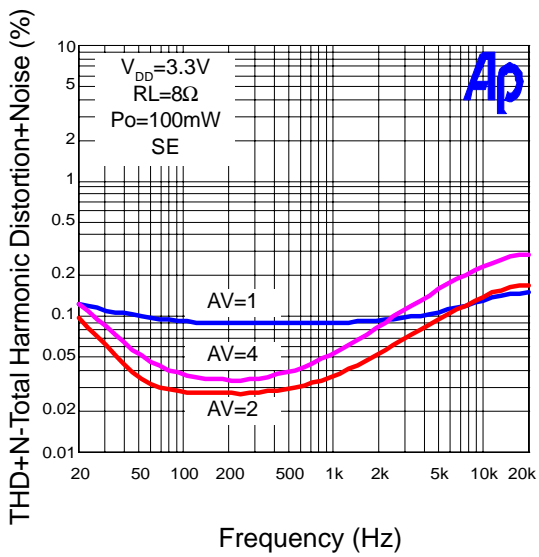
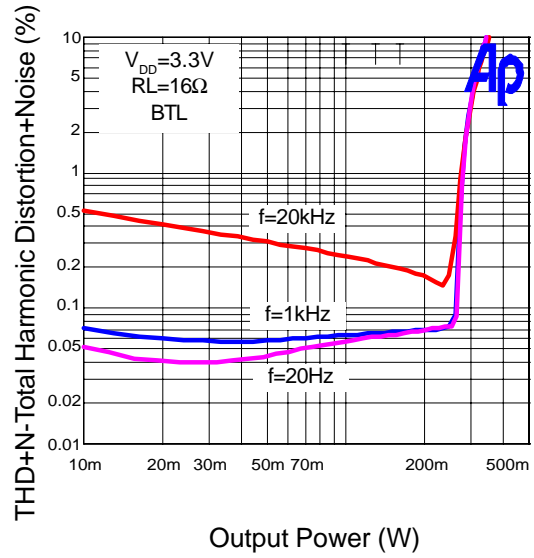
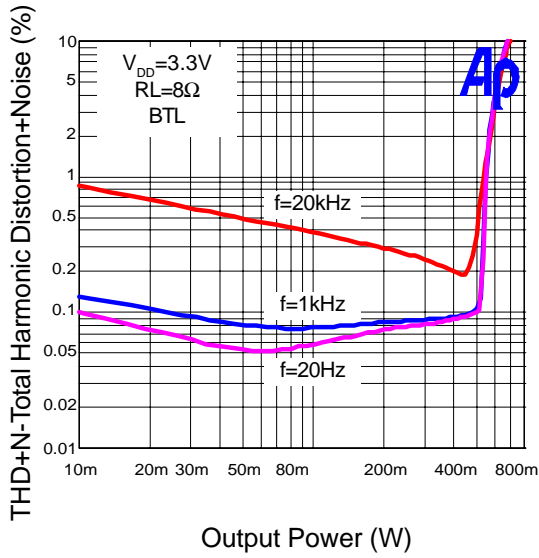

Typical Characteristics (Cont.)

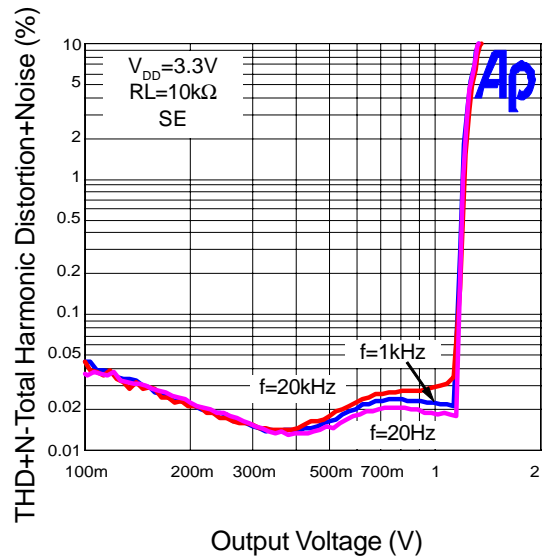
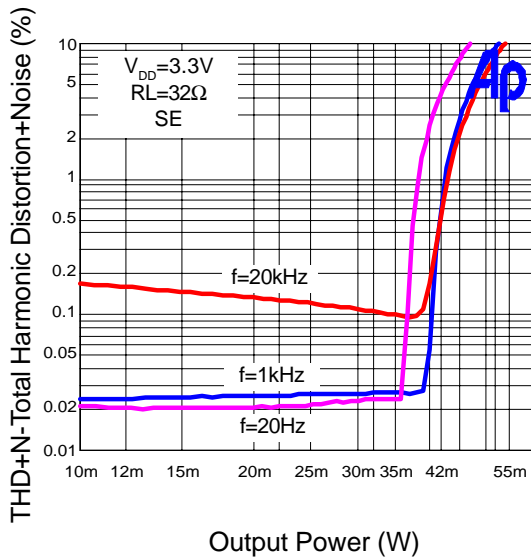
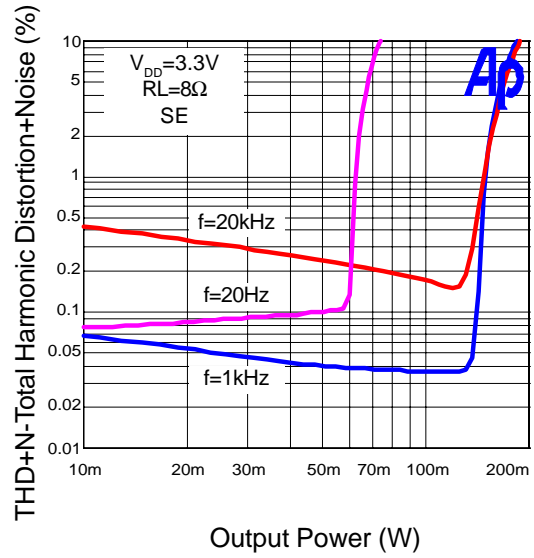
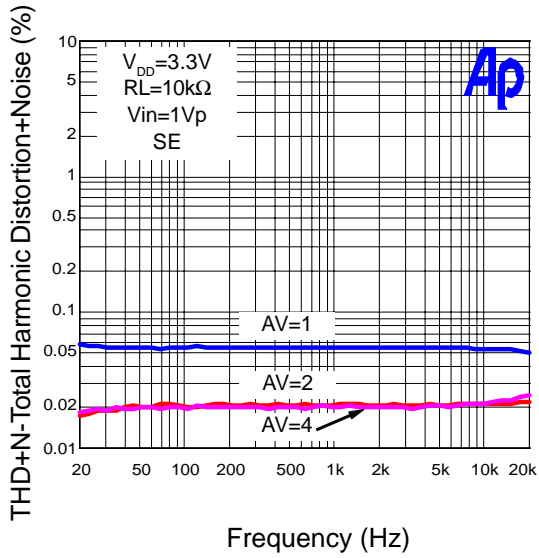

Typical Characteristics (Cont.)

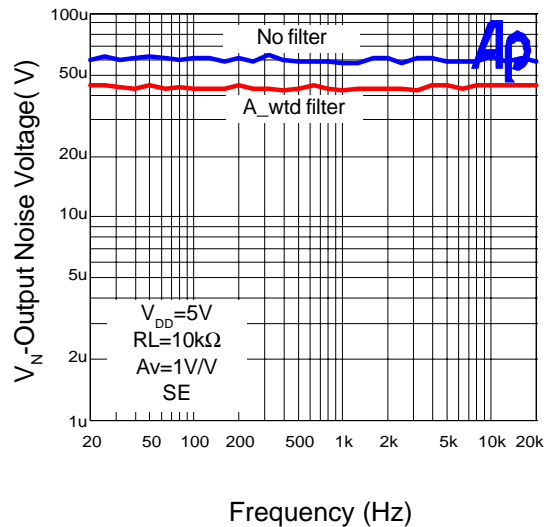
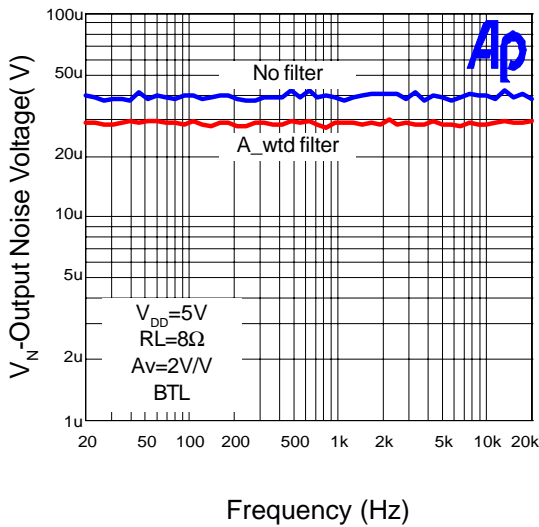
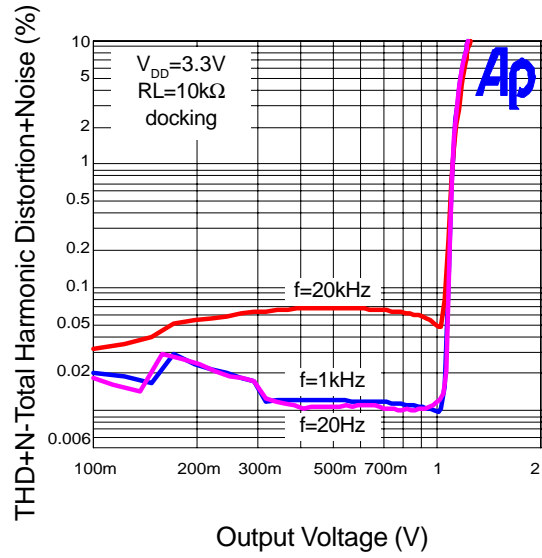
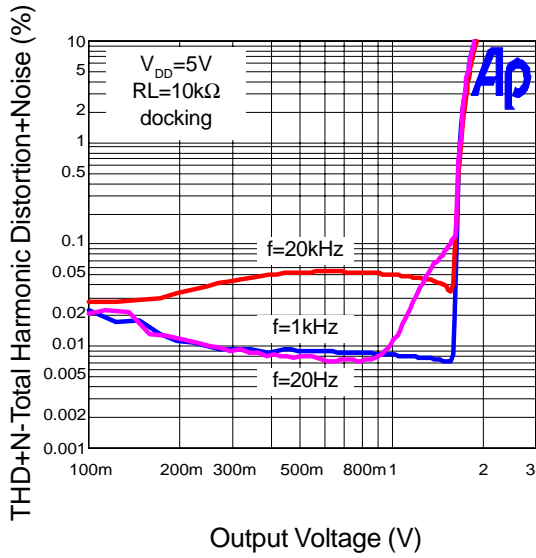

Typical Characteristics (Cont.)

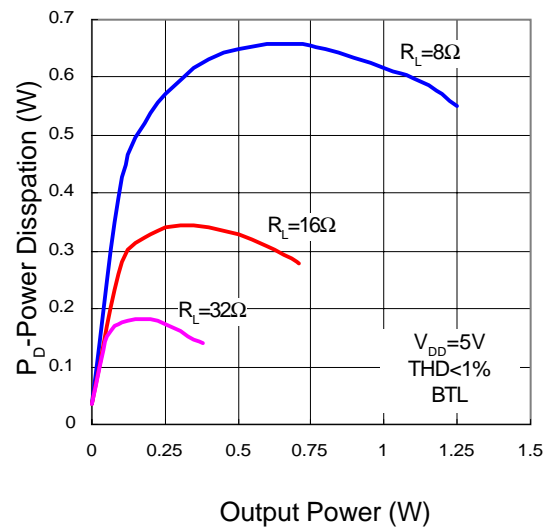
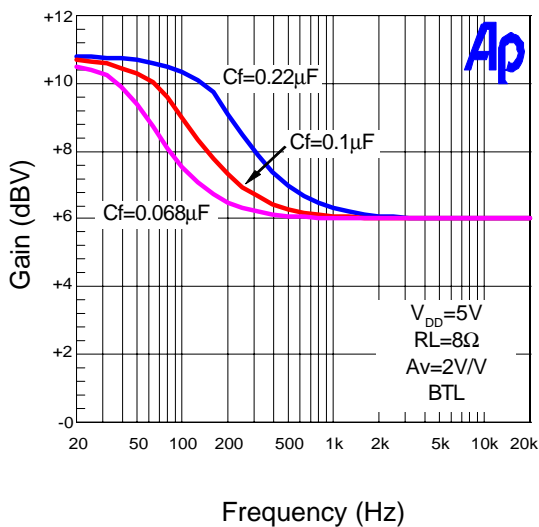
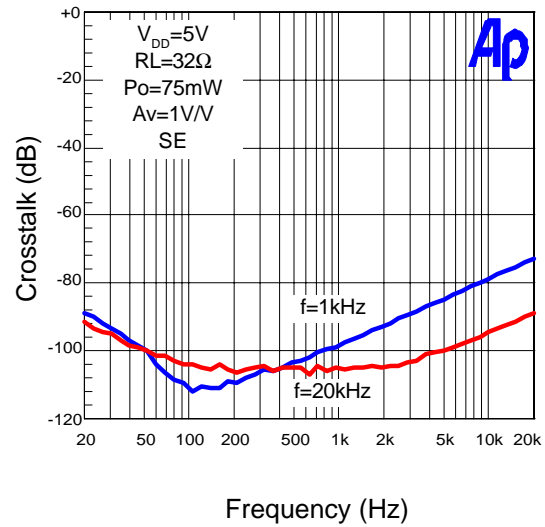
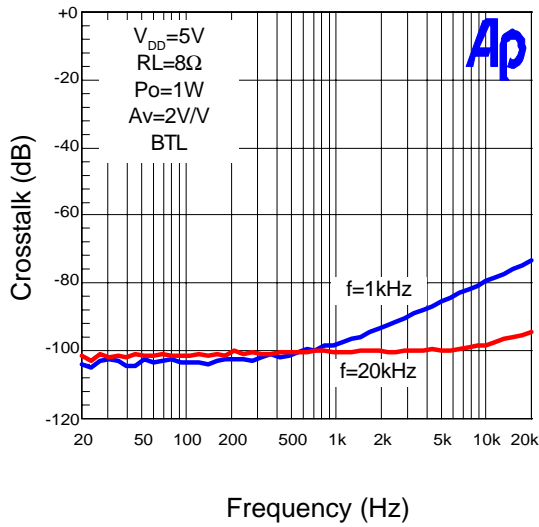

Typical Characteristics (Cont.)

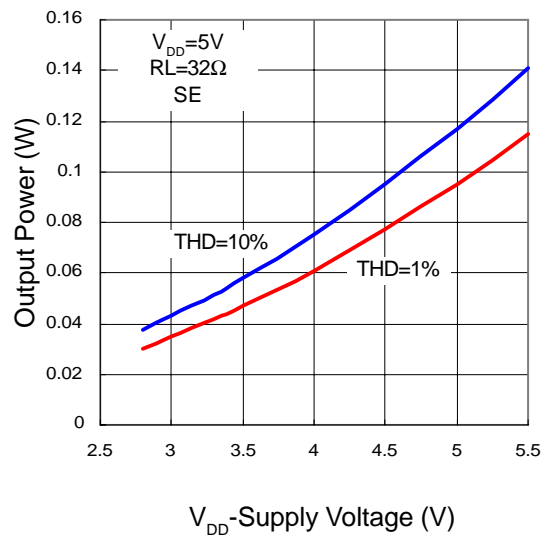
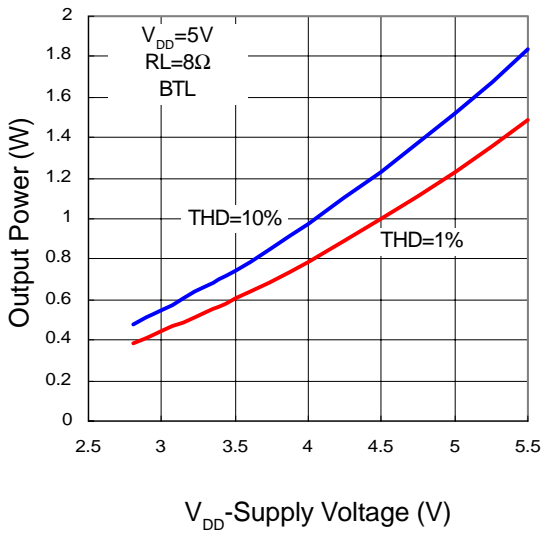
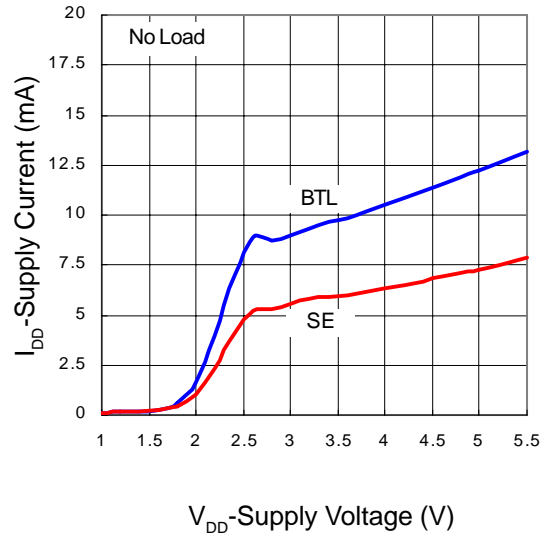
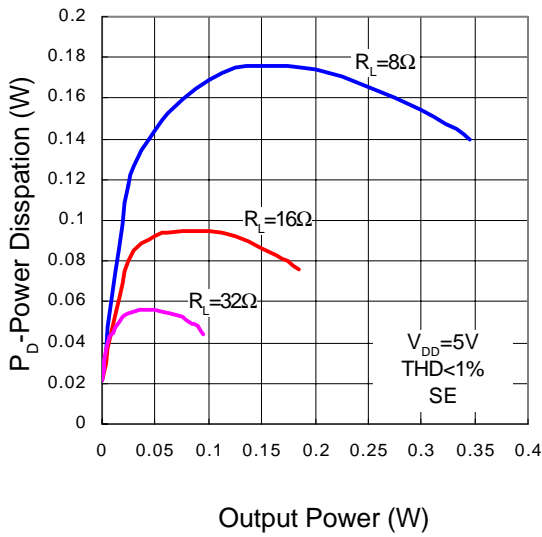

Typical Characteristics (Cont.)

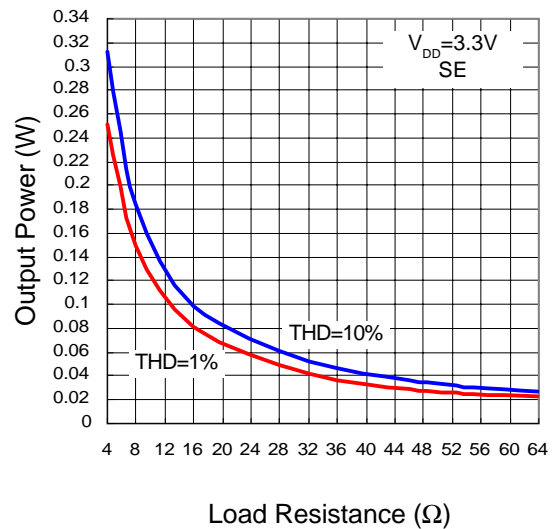
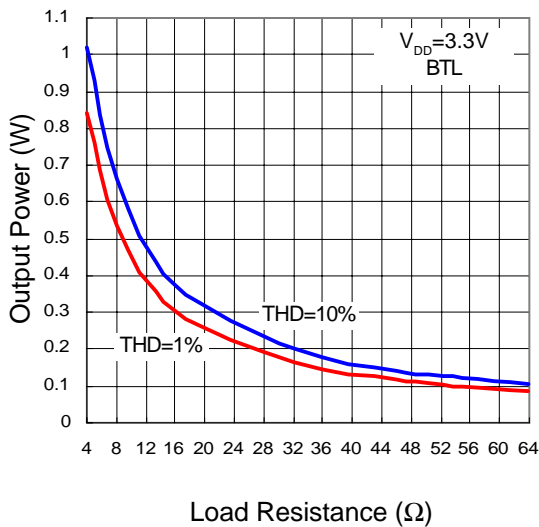
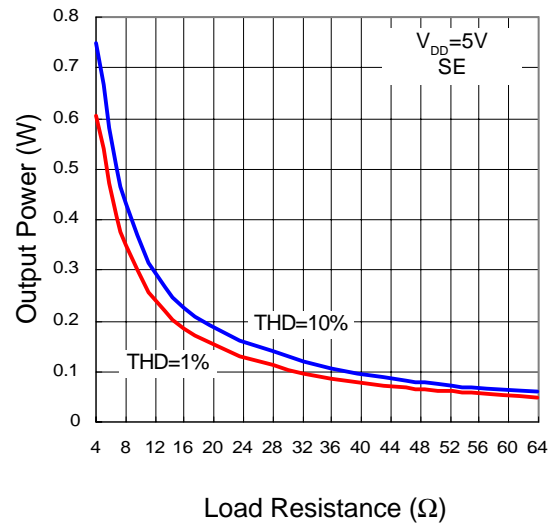
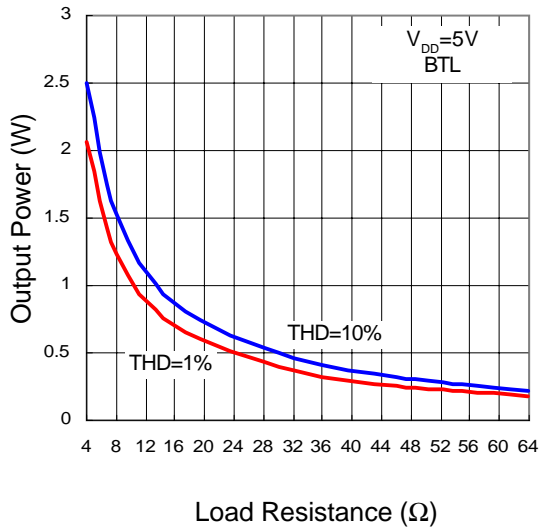

Typical Characteristics (Cont.)

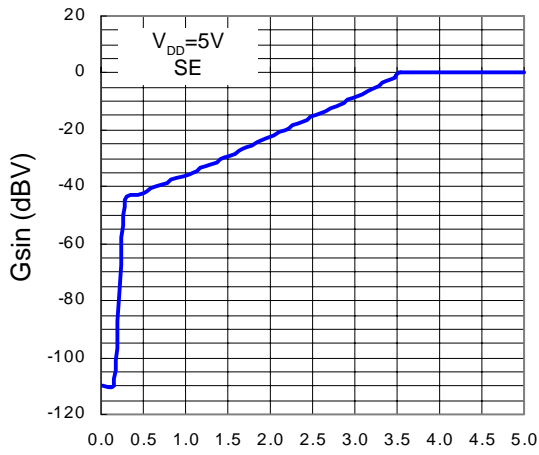

Voltage (V)

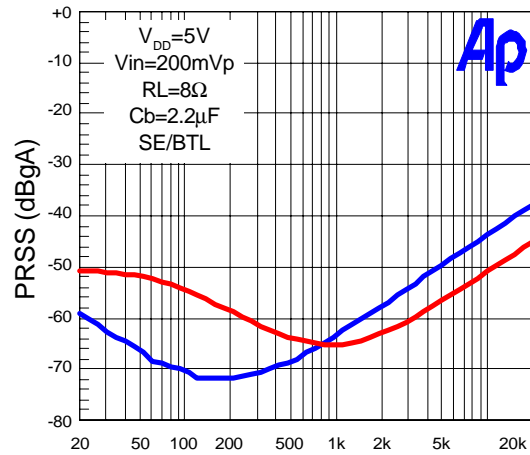

Frequency (Hz)

Packaging Information

SO – 300mil (Reference JEDEC Registration MS-013)

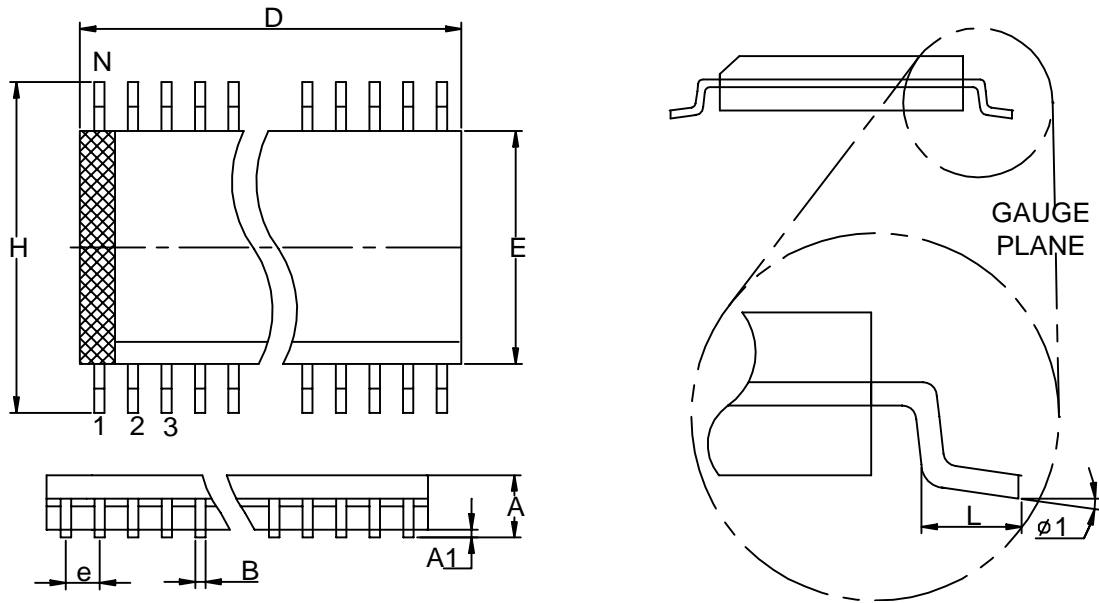

Dim	Millimeters		Variations- D			Dim	Inches		Variations- D		
	Min.	Max.	Variations	Min.	Max.		Min.	Max.	Variations	Min.	Max.
A	2.35	2.65	SO-16	10.10	10.50	A	0.093	0.1043	SO-16	0.398	0.413
A1	0.10	0.30	SO-18	11.35	11.76	A1	0.004	0.0120	SO-18	0.447	0.463
B	0.33	0.51	SO-20	12.60	13	B	0.013	0.020	SO-20	0.496	0.512
D	See variations		SO-24	15.20	15.60	D	See variations		SO-24	0.599	0.614
E	7.40	7.60	SO-28	17.70	18.11	E	0.2914	0.2992	SO-28	0.697	0.713
e	1.27BSC		SO-14	8.80	9.20	e	0.050BSC		SO-14	0.347	0.362
H	10	10.65				H	0.394	0.419			
L	0.40	1.27				L	0.016	0.050			
N	See variations					N	See variations				
φ 1	0°	8°				φ 1	0°	8°			

Packaging Information (Cont.)

PDIP-16 pin (Reference JEDEC Registration MS-001)

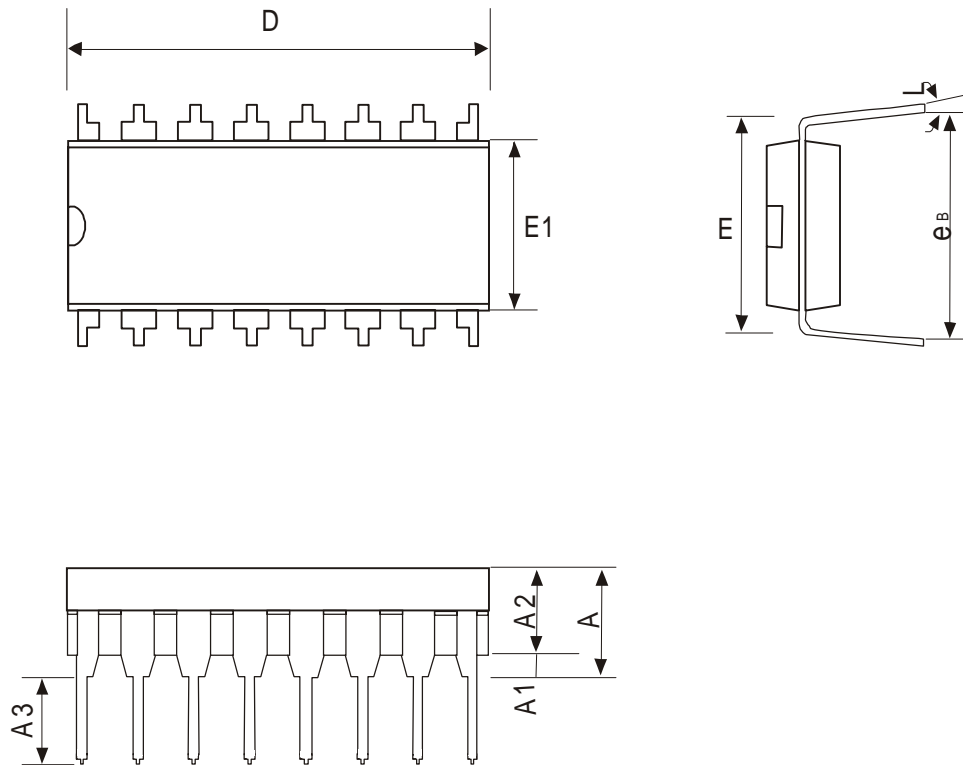

Dim	Millimeters		Inches	
	Min.	Max.	Min.	Max.
A	-	5.320	-	0.210
A1	0.380	-	0.015	-
A2	3.169	3.422	0.125	0.135
A3	2.915	3.803	0.115	0.150
D	18.632	19.646	0.735	0.775
E	7.605BSC		0.300BSC	
E1	6.210	6.464	0.245	0.255
L°	0	380.25	0	15
e _B	8.492	9.506	0.335	0.375

Physical Specifications

Terminal Material	Solder-Plated Copper (Solder Material : 90/10 or 63/37 SnPb)
Lead Solderability	Meets EIA Specification RSI86-91, ANSI/J-STD-002 Category 3.

Reflow Condition (IR/Convection or VPR Reflow)

Reference JEDEC Standard J-STD-020A APRIL 1999

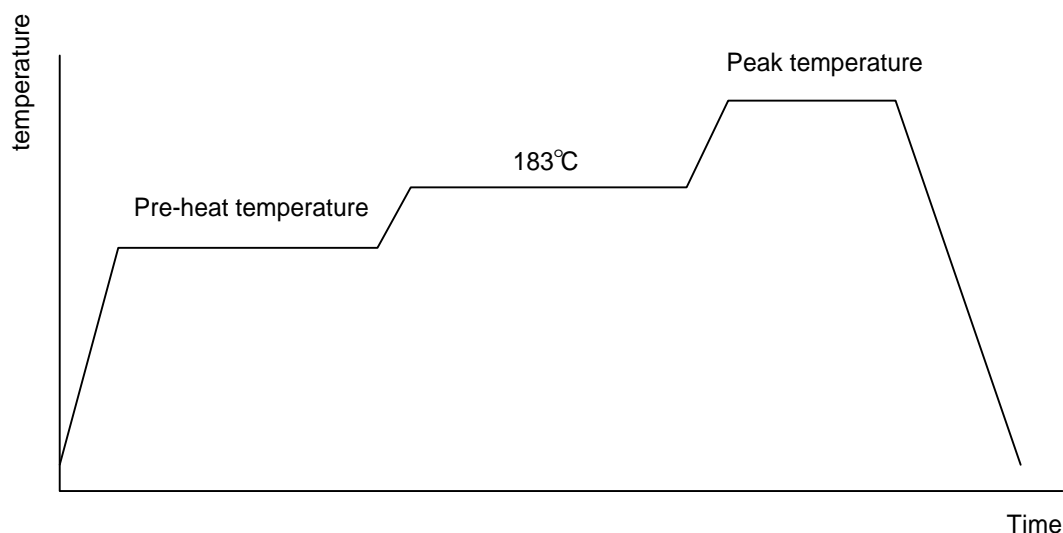

Classification Reflow Profiles

	Convection or IR/ Convection	VPR
Average ramp-up rate(183°C to Peak)	3°C/second max.	10 °C /second max.
Preheat temperature 125 ± 25°C)	120 seconds max	
Temperature maintained above 183°C	60 – 150 seconds	
Time within 5°C of actual peak temperature	10 –20 seconds	60 seconds
Peak temperature range	220 +5/-0°C or 235 +5/-0°C	215-219°C or 235 +5/-0°C
Ramp-down rate	6 °C /second max.	10 °C /second max.
Time 25°C to peak temperature	6 minutes max.	

Package Reflow Conditions

pkg. thickness ≥ 2.5mm and all bgas	pkg. thickness < 2.5mm and pkg. volume ≥ 350 mm ³	pkg. thickness < 2.5mm and pkg. volume < 350mm ³
Convection 220 +5/-0 °C		Convection 235 +5/-0 °C
VPR 215-219 °C		VPR 235 +5/-0 °C
IR/Convection 220 +5/-0 °C		IR/Convection 235 +5/-0 °C

Reliability test Program

Test item	Method	Description
SOLDERABILITY	MIL-STD-883D-2003	245° C , 5 SEC
HOLT	MIL-STD-883D-1005.7	1000 Hrs Bias @ 125 °C
PCT	JESD-22-B, A102	168 Hrs, 100 % RH , 121 °C
TST	MIL-STD-883D-1011.9	-65° C ~ 150° C , 200 Cycles
ESD	MIL-STD-883D-3015.7	VHBM > 2KV, VMM > 200V
Latch-Up	JESD 78	10ms , I _{tr} > 100mA

Carrier Tape & Reel Dimensions

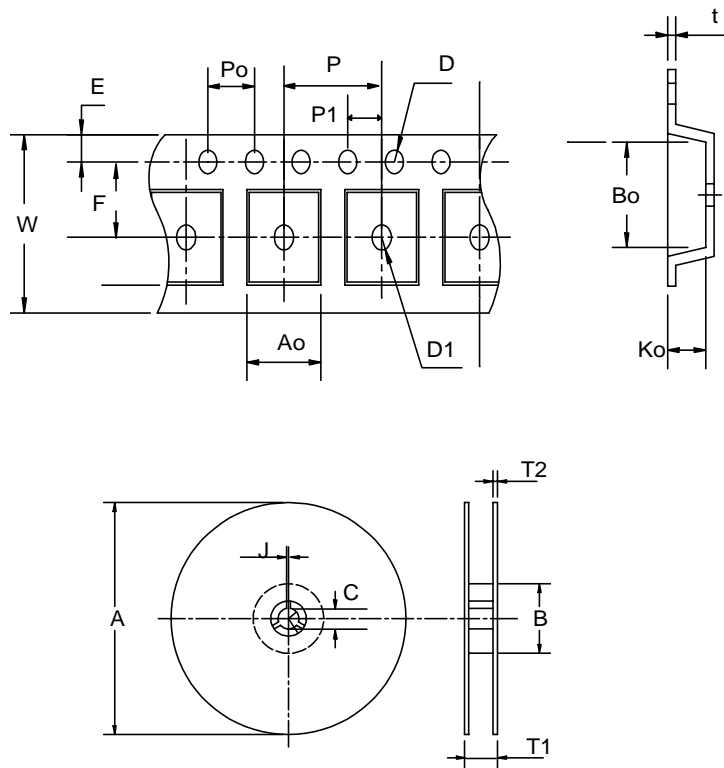

Application	A	B	C	J	T1	T2	W	P	E
SOP- 8	330 ± 1	62 +1.5	12.75+ 0.15	2 ± 0.5	12.4 ± 0.2	2 ± 0.2	12± 0.3	8± 0.1	1.75±0.1
	F	D	D1	Po	P1	Ao	Bo	Ko	t
	5.5± 1	1.55 +0.1	1.55+ 0.25	4.0 ± 0.1	2.0 ± 0.1	6.4 ± 0.1	5.2± 0.1	2.1± 0.1	0.3±0.013

Cover Tape Dimensions

Application	Carrier Width	Cover Tape Width	Devices Per Reel
SOP- 8	12	9.3	2500

Customer Service

Anpec Electronics Corp.

Head Office :

5F, No. 2 Li-Hsin Road, SBIP,

Hsin-Chu, Taiwan, R.O.C.

Tel : 886-3-5642000

Fax : 886-3-5642050

Taipei Branch :

7F, No. 137, Lane 235, Pac Chiao Rd.,

Hsin Tien City, Taipei Hsien, Taiwan, R. O. C.

Tel : 886-2-89191368

Fax : 886-2-89191369