

Silicon Unijunction Transistors

www.DataSheet4U.com

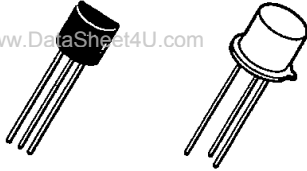

TO-92

TO-18

The GE/RCA 2N2646, GES2646 and 2N2647, GES2647 silicon-unijunction transistors have an entirely new structure resulting in lower saturation voltage, peak-point current and valley current as well as a much higher base-one peak pulse voltage. In addition, these devices are much faster switches.

The 2N2646 and GES2646 are intended for general purpose industrial applications where circuit economy is of primary importance, and is ideal for use in firing circuits for Silicon

Controlled Rectifiers and other applications where a guaranteed minimum pulse amplitude is required. The 2N2647 and GES2647 are intended for applications where a low emitter leakage current and a low peak point emitter current (trigger current) are required (i.e., long timing applications), and also for triggering high power SCR's. These types are supplied in JEDEC TO-18 package (2N2646, 2N2647) and in JEDEC TO-92 packages (GES2646, GES2647).

MAXIMUM RATINGS, Absolute-Maximum Values:

EMITTER REVERSE VOLTAGE	30 V
INTERBASE VOLTAGE	35 V
RMS EMITTER CURRENT	50 mA
PEAK EMITTER CURRENT (Note 1)	2 A
POWER DISSIPATION (Note 2)	300 mW
OPERATING TEMPERATURE RANGE	-65° to +125°C
STORAGE TEMPERATURE RANGE	-65° to +150°C

NOTES:

1. Capacitor discharge — 10µF or less, 30 V or less.
2. Derate 3 mW/°C increase in ambient temperature. The total power dissipation (available power to Emitter and Base-Two) must be limited by the external circuitry.

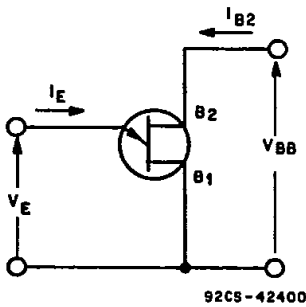

Fig. 1—Unijunction transistor symbol and nomenclature used for current and voltage circuit.

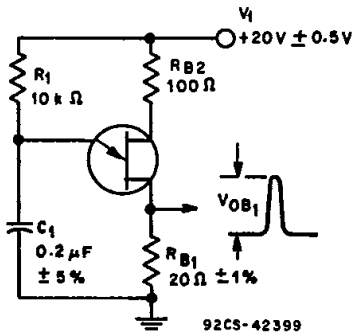

Fig. 2—Typical base-1 peak-pulse voltage circuit.

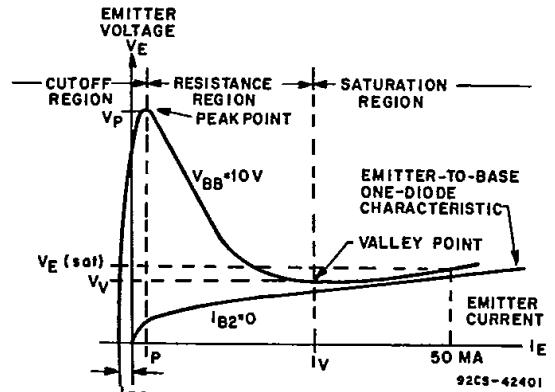

Fig. 3—Static emitter characteristics waveforms.

Unijunction Transistors and Switches

2N2646, 2N2647, GES2646, GES2647

ELECTRICAL CHARACTERISTICS, At Ambient Temperature (T_A) = 25°C Unless Otherwise Specified

www.DataSheet4U.com

CHARACTERISTICS	SYMBOL	LIMITS						UNITS
		2N2646, GES2646			2N2647, GES2647			
		MIN.	TYP.	MAX.	MIN.	TYP.	MAX.	
Intrinsic Standoff Ratio ($V_{BB} = 10\text{ V}$)	η	0.56	0.69	0.75	0.68	0.77	0.82	—
Interbase Resistance ($V_{BB} = 3\text{ V}, I_E = 0$)	R_{BB0}	4.7	6.7	9.1	4.7	6.7	9.1	k Ω
Emitter Saturation Voltage ($V_{BB} = 10\text{ V}, I_E = 50\text{ mA}$)	$V_E(\text{sat})$	—	2	—	—	2	—	V
Modulated Interbase Current ($V_{BB} = 10\text{ V}, I_E = 50\text{ mA}$)	$I_{B2}(\text{mod})$	—	24	—	—	27	—	mA
Emitter Reverse Current ($V_{B2E} = 30\text{ V}, I_{B1} = 0$)	I_{EO}	—	0.001	12	—	0.001	0.2	μA
Peak Point Emitter Current ($V_{BB} = 25\text{ V}$)	I_P	—	0.8	5	—	1	2	—
Valley Point Current ($V_{BB} = 20\text{ V}, R_{B2} = 100\ \Omega$)	I_V	4	5	—	8	9	18	mA
Base-One Peak Pulse Voltage (Note 1)(Fig. 2)	V_{OB1}	3	8.5	—	6	9.5	—	V

NOTES:

- The Base-1 peak pulse voltage is measured in the circuit below. This specification on the 2N2646 and 2N2647 is used to ensure a minimum pulse amplitude for applications in SCR firing circuits and other types of pulse circuits.
- SCR firing conditions—see Figs. 19, 20, 21, and 22.

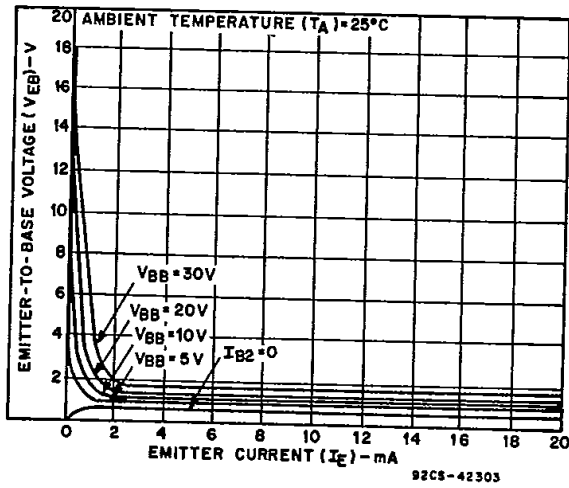

Fig. 4—Typical static emitter characteristics.

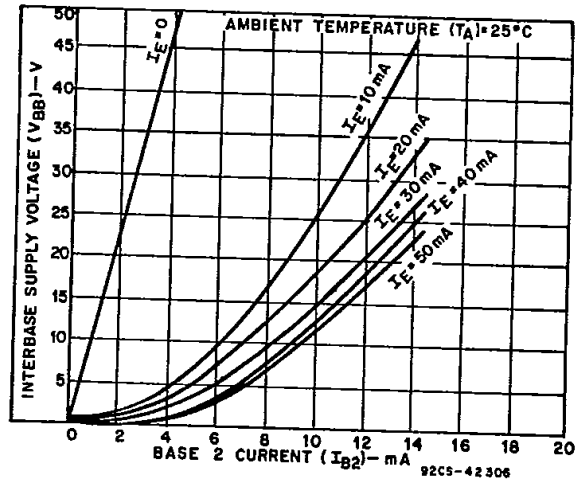

Fig. 5—Typical static interbase characteristics

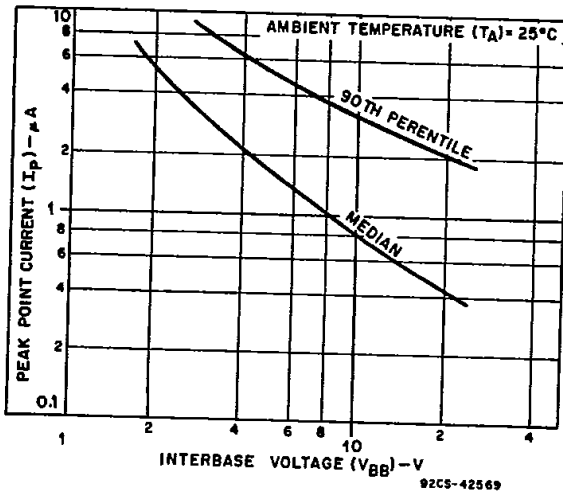

Fig. 6—Typical peak point current characteristics.

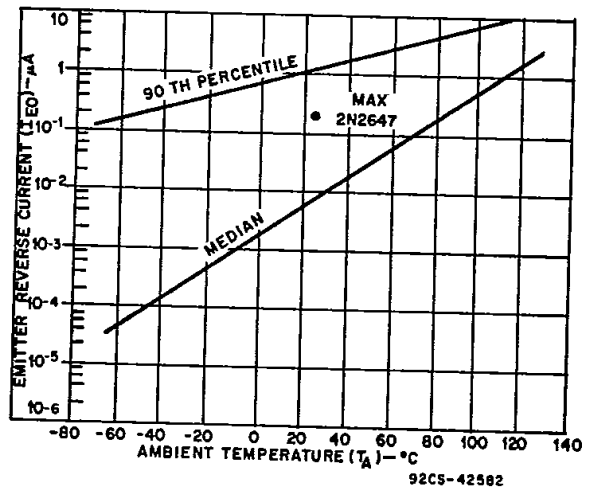

Fig. 7—Typical emitter reverse current characteristics.

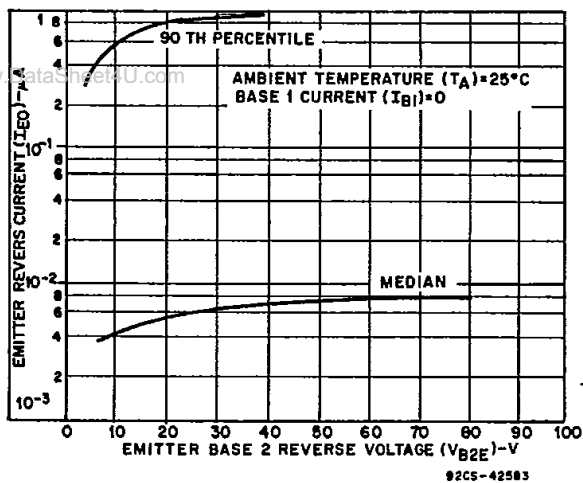

Fig. 8 - Typical emitter reverse current characteristics.

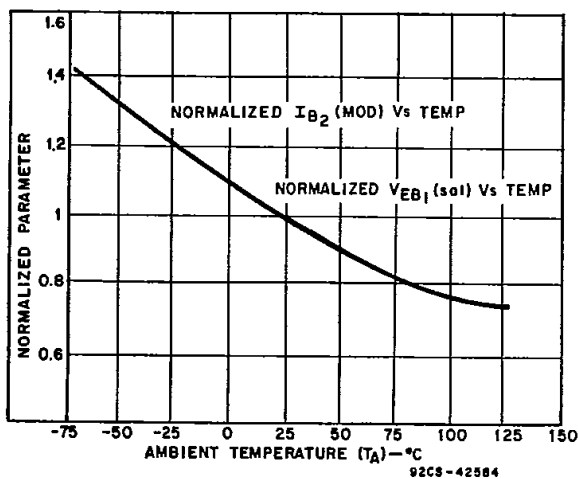

Fig. 9 - Normalized base-2 current and base-1 saturation voltage characteristic.

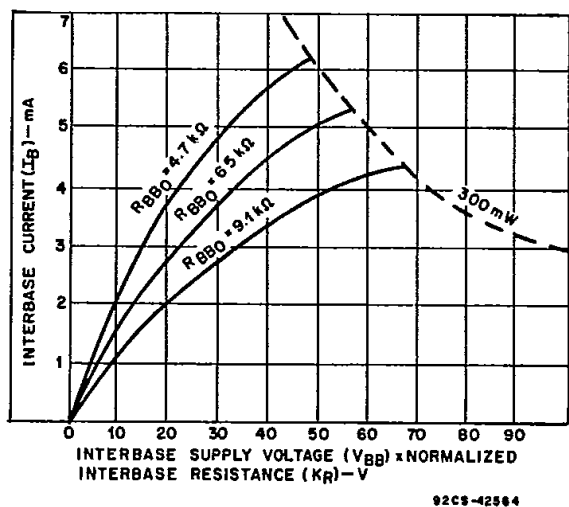

Fig. 10 - Typical interbase characteristics.
 Interbase characteristics at any junction temperature may be determined by dividing the horizontal scale by K_R , see Fig. 11.

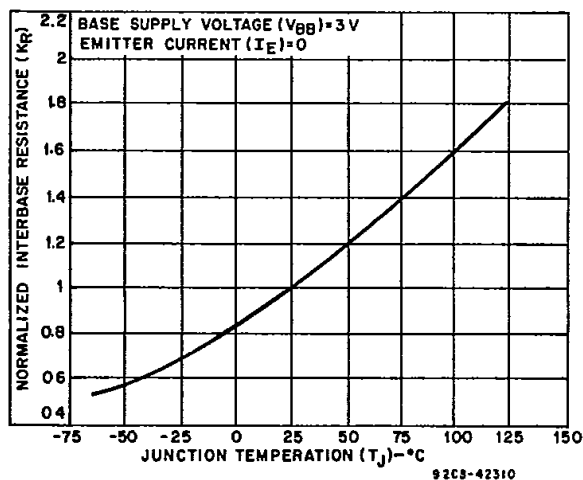

Fig. 11 - Normalized interbase resistance characteristic.

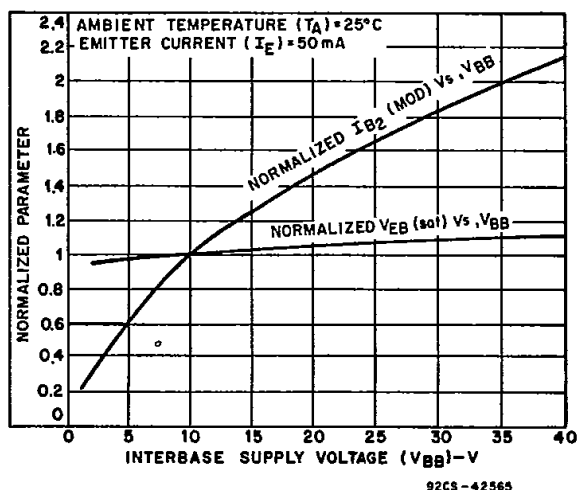

Fig. 12 - Normalized base-2 current and base-1 saturation voltage characteristics.

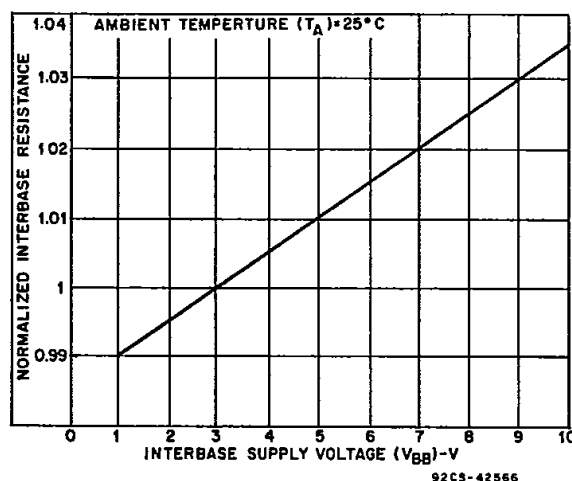

Fig. 13 - Normalized interbase resistance characteristic.

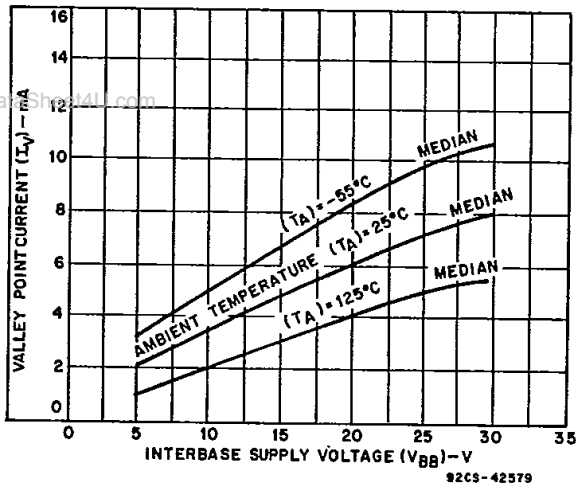

Fig. 14—Valley point current vs. base voltage, for 2N2646 only.

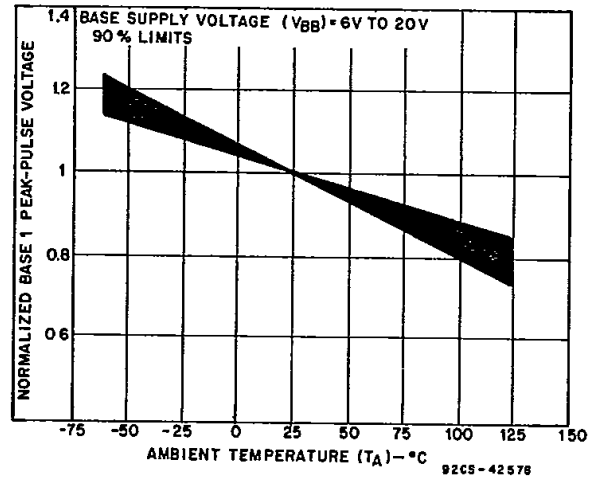

Fig. 15—Normalized base 1 peak-pulse voltage vs. ambient temperature.

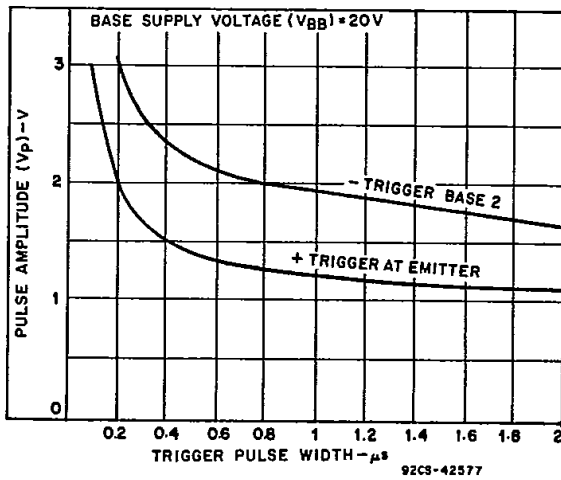

Fig. 16—Minimum trigger pulse amplitude vs. trigger pulse width for turn-on of unijunction transistor

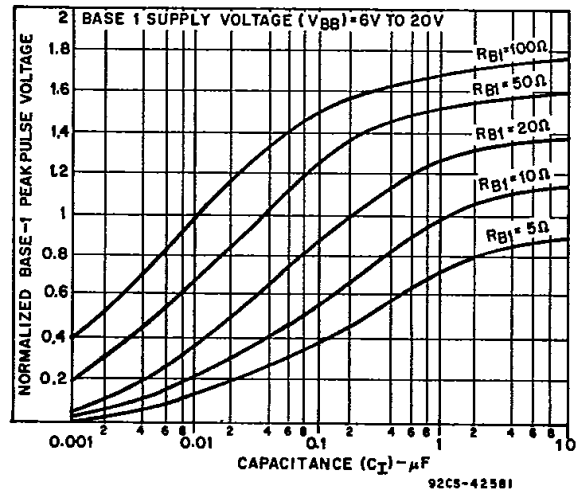

Fig. 17—Normalized base 1 peak pulse voltage vs. capacitance.

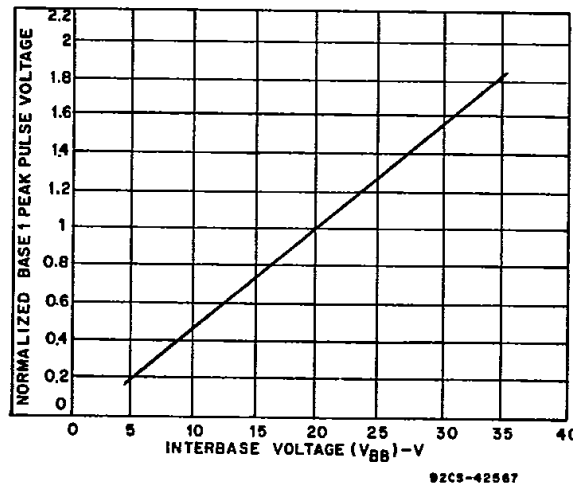

Fig. 18—Normalized base 1 peak pulse voltage vs. interbase voltage.

2N2646, 2N2647, GES2646, GES2647

www.DataSheet4U.com

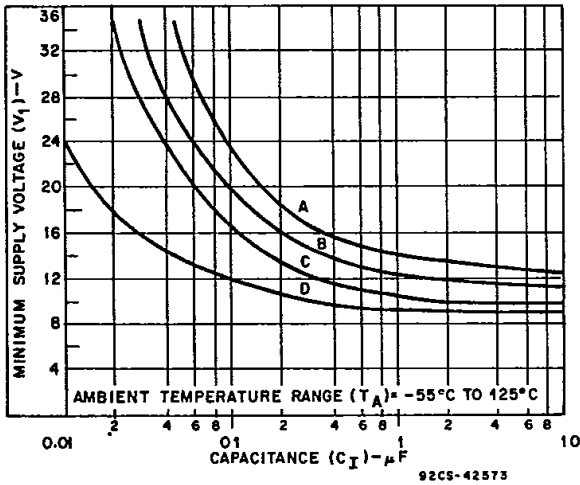
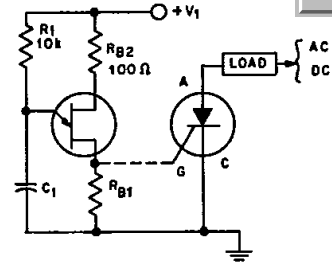

Fig. 19—Minimum supply voltage characteristics. See Fig. 20 for circuit and curve data.



CURVE	SCR TYPE	RB1	V1(MAX)
A	C35,C36	27 Ω ± 10%	35 V
B	C35,C36	47 Ω ± 10%	20 V
B	C10,C11	27 Ω ± 10%	32 V
C	C10,C11	47 Ω ± 10%	18 V
C	C35,C36	SPRAGUE 11Z12	35 V
D	C10,C11	PULSE TRANS.	35 V

NOTE:
C35-2N481-92
C36-2N1842-50
C10-2N1770A-77A
C11-2N1770-78

92CS-42571

Fig. 20—Circuit for minimum supply voltage curves, Fig. 19.

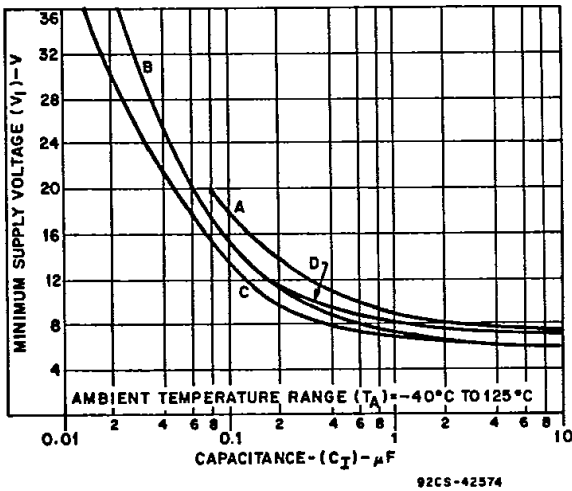
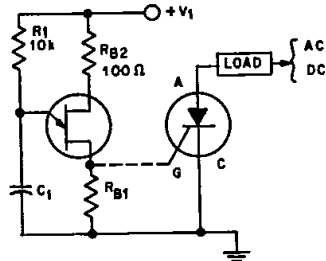

Fig. 21—Minimum supply voltage characteristics. See Fig. 22 for circuit and curve data.

CURVE	SCR TYPE	RB1	V1(MAX)
B	C60(2N2023-30)	27 Ω ± 10%	35 V
C	C52(2N1782-99)	47 Ω ± 10%	20 V
C	C50(2N1909-16) C45 AND C46 8C30,40,50 AND 140 SERIES	PULSE TRANS. PE2231	35 V



92CS-42572

Fig. 22—Circuit for minimum supply voltage curves, Fig. 21.

TERMINAL CONNECTIONS

- TO-92**
Lead 1 - Emitter
Lead 2 - Base 1
Lead 3 - Base 2

TERMINAL CONNECTIONS

- TO-18**
Lead 1 - Emitter
Lead 2 - Base 1
Lead 4 - Base 2