

Universal Serial Bus Transceiver with Level Translator

Features

- Complies with USB Specification Rev 1.1 & 2.0
- Supports full speed (12Mbit/sec.) and low speed (1.5Mbits/sec.) modes
- Integrated 5V to 3.3V regulator
- Used as a USB device transceiver or host transceiver
- V_{BUS} disconnection indication through V_P and V_M outputs
- Two single-ended receivers with hysteresis
- USB Detection of V_{BUS} via level translator
- Stable RCV output during SE0 condition
- Low power operation from V_{CC}
- Supports 1.65V to 3.6V I/O voltage levels
- Full industrial operating range -40 to 85 °C
- Available in small HBCC-16 and TSSOP-16 packages

Applications

- Wireless handsets
- Digital still cameras
- PDAs (Personal Digital Assistants)
- IAs (Information Appliances)

Product Description

The CM2400-02/03/04 Universal Serial Bus (USB) transceiver is fully compliant with the USB specification Rev 1.1 and 2.0. It supports a speed of 12Mbits/s (Full Speed Mode).

An internal level shifter allows interface to Application Specific ICs (ASICs) and Programmable Logic Devices (PLD's) running at core voltages of 1.65V to 3.6V.

The CM2400-02/03/04 features an internal 5V to 3.3V regulator which is used to power the USB transceiver via the USB supply V_{BUS} .

The CM2400-04 features a Mode Input pin (MODE) which allows the device to operate in either single or differential input mode.

This device is ideal for portable electronic devices such as mobile phones, digital still cameras, PDAs (Personal Digital Assistants) and IAs (Information Appliances). The CM2400-02/03/04 is packaged in a small form-factor 16-lead HBCC or TSSOP package to conserve board space.

Simplified Block Schematic

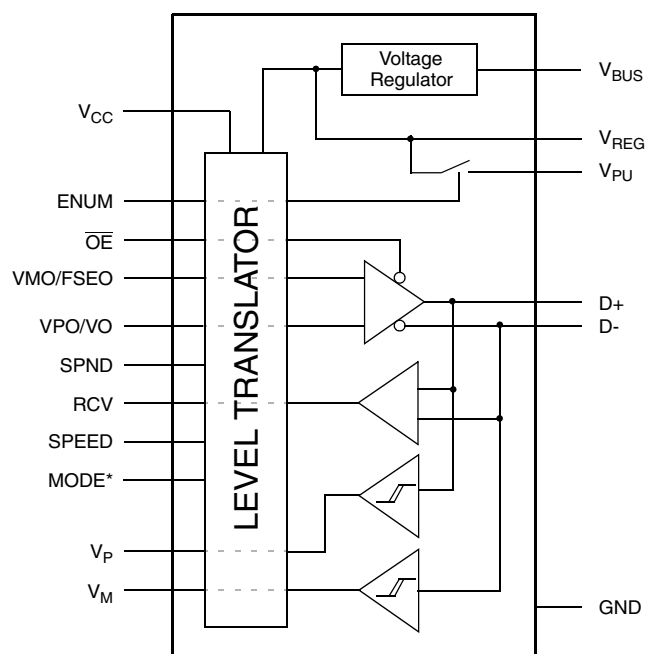

* MODE pin available on CM2400-04 only.

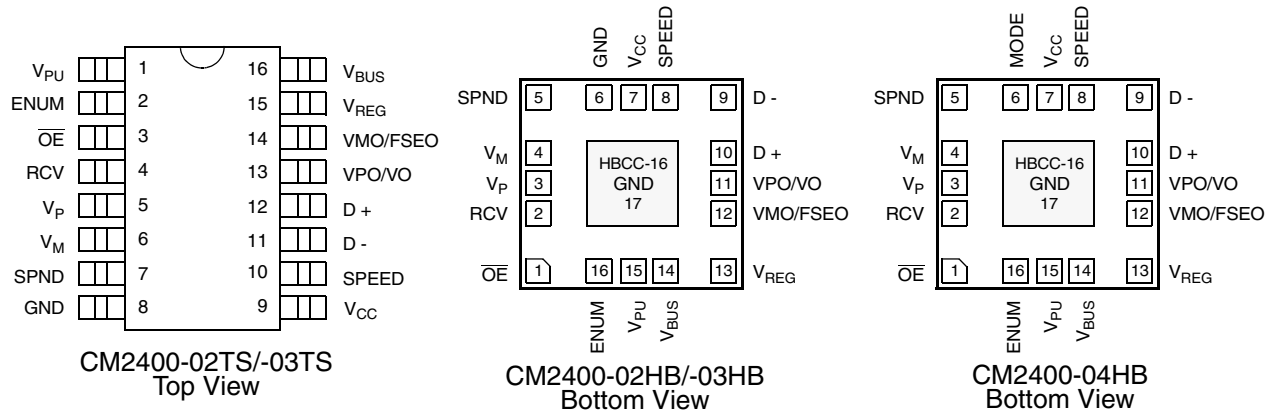
PACKAGE / PINOUT DIAGRAM

Note: These drawings are not to scale.

PIN DESCRIPTIONS

HBCC-16 PINS	TSSOP-16 PINS	NAME	DESCRIPTION
1	3	OE	Input for Output Enable (Active low). Enables transceiver driver to transmit data on the USB bus. When OE pin = LOW, driver circuitry is enabled.
2	4	RCV	Differential receiver output of D+ and D- input data lines. The output state of RCV is preserved and stable during an SE0 condition.
3	5	V _P	Single-ended D+ receiver output for detection of a single-ended zero or error conditions
4	6	V _M	Single-ended D- receiver output for detection of a single-ended zero or error conditions.
5	7	SPND	Suspend input. Allows the device to enter a low power state while the USB is inactive.
6	8	MODE	Mode input (CM2400-04). Selects between differential (V _{PO} , V _{MO}) and single-ended mode (V _O , FSEO).
		GND	Ground input (CM2400-02/03).
7	9	V _{CC}	Supply voltage for digital I/O pins. Voltages supported: 1.65 to 3.6V.
8	10	SPEED	Speed Input. If SPEED is logic '1', selects full speed. If SPEED is logic '0', selects low speed. SPEED changes slope rise and fall time on D+ and D-.
9	11	D-	Negative USB data connection.
10	12	D+	Positive USB data connection. In full-speed connect mode, connect to V _{PU} via a 1.5kΩ resistor. Tolerance of this resistor is defined in the USB specification REV 1.1 & 2.0
11	13	VPO/VO	Driver data input.
12	14	VMO/FSEO	Driver data input.
13	15	V _{REG}	Regulated supply voltage output during USB operation of V _{BUS} . 1μF decoupling capacitor is required.
14	16	V _{BUS}	Supply voltage input. Can be directly connected to USB V _{BUS} .
15	1	V _{PU}	Pull-up supply voltage. Pin function is controlled by input ENUM.

PIN DESCRIPTIONS (CONT'D)

16	2	ENUM	Enumerate, allows software to control connection of the external pull-up via the level translator. If ENUM = LOW then V_{PU} is floating. If ENUM = HIGH then V_{PU} is internally connected to V_{REG} .
17	-	GND	The ground terminal is connected to the exposed diepad (heatsink).

Ordering Information
PART NUMBERING INFORMATION

PADS/ LEADS	Package	Standard Finishing		Lead-free Finishing ²	
		Ordering Part Number ¹	Part Marking	Ordering Part Number ¹	Part Marking
16	HBCC-16	CM2400-02HB	CM240002HB	CM2400-02HA	CM240002HA
16	TSSOP-16	CM2400-02TS	CM240002TS	CM2400-02TR	CM240002TR
16	HBCC-16	CM2400-03HB	CM240003HB	CM2400-03HA	CM240003HA
16	TSSOP-16	CM2400-03TS	CM240003TS	CM2400-03TR	CM240003TR
16	HBCC-16	CM2400-04HB	CM240004HB	CM2400-04HA	CM240004HA

Note 1: Parts are shipped in Tape & Reel form unless otherwise specified.

Note 2: Lead-free, 100% tin plated.

Specifications
ABSOLUTE MAXIMUM RATINGS

PARAMETER	RATING	UNITS
ESD Protection (All Pins except D+/D- pins, HBM, See Note 1)	± 1000	V
ESD Protection (D+/D- pins, HBM, See Note 1)	± 4000	V
V_{BUS}	[GND - 0.5] to +5.5	V
V_{CC}	[GND - 0.5] to +6.0	V
V_I (INPUT)	[GND - 0.5] to [$V_{CC} + 0.5$]	V
Storage Temperature Range	-65 to +150	°C
Operating Temperature Range Junction	-40 to +150	°C

Note 1: Equivalent to discharging a 100pF capacitor via a 1.5k Ω resistor (Human body model).

STANDARD (RECOMMENDED) OPERATING CONDITIONS

SYMBOL	PARAMETER	MIN	TYP	MAX	UNITS
V_{BUS}	USB V_{BUS} Supply	4.0	5.0	5.5	V
V_{CC}	DC System Supply	1.65	3.3	3.6	V
V_I	DC Input Voltage	0	-	V_{CC}	V
$V_{I(AI/O)}$	Analog I/O Pins (D+, D-)	0	-	3.6	V
T_A	Ambient Operating Temperature Range	-40	-	+85	°C

Specifications (cont'd)

ELECTRICAL OPERATING CHARACTERISTICS (SEE NOTE 1)						
Supply Pins ($V_{BUS} = 4.0V$ to $5.5V$; $V_{CC} = 1.65V$ to $3.6V$)						
SYMBOL	PARAMETER	CONDITIONS	MIN	TYP	MAX	UNITS
V_{REG}	Regulated supply output	Unloaded	3.0	3.3	3.6	V
I_{BUS}	Operating supply current	Full-speed TX and RX; $C_L=50pF$ on D+/D- outputs; Note 2			8	mA
$I_{BUS(IDLE)}$	Supply current during full speed idle and SE0	Full-speed idle; Notes 3 & 4			500	μA
$I_{BUS(DIS)}$	Disable mode supply current	V_{CC} not present; Note 4			60	μA
$I_{BUS(SUSP)}$	Suspend mode supply current	SPND = HIGH; Notes 3 & 4			60	μA
I_{CC}	Operating I/O supply current	Full-speed TX and RX; Note 5			1.0	mA
$I_{CC(STAT)}$	Static I/O supply current	Full-speed idle, SE0 or suspend; Note 5			1.0	μA
$I_{CC(SHARE)}$	Supply current during sharing mode	V_{BUS} not connected; Note 5			1.0	μA
$I_{DX(SHARE)}$	D+/D- load current during sharing mode	V_{BUS} not connected; ENUMERATE = LOW; Note 5			1.0	μA
$V_{TH(VBUS)}$	V_{BUS} supply detection threshold	Supply lost			0.8	V
		Supply present	2.4			V
$V_{TH(VCC)}$	V_{CC} supply detection threshold	Supply lost (USB_D low)			0.5	V
		Supply present	1.4			V
Digital Pins ($V_{BUS} = 4.0V$ to $5.5V$; $V_{CC} = 1.8V \pm 0.15V$)						
SYMBOL	PARAMETER	CONDITIONS	MIN	TYP	MAX	UNITS
V_{IL}	Logic LOW input voltage				0.5	V
V_{IH}	Logic HIGH input voltage		1.2			V
V_{OL}	Logic LOW output voltage	$I_{OL} = 100\mu A$			0.15	V
		$I_{OL} = 2mA$			0.40	V
V_{OH}	Logic HIGH output voltage	$I_{OH} = 100\mu A$	1.50			V
		$I_{OH} = 2mA$	1.25			V

Note 1: Operating Characteristics are over Standard Operating Conditions unless otherwise specified.

Note 2: Equivalent to discharging a 100pF capacitor via a 1.5k Ω resistor (Human body model).

Note 3: Excluding any load current and V_{PU}/V_{SW} source current to 1.5k Ω and 15k Ω pull-up and pull-down resistors (200 μA).

Note 4: Current is drawn from VBUS of Host when device is a peripheral.

Note 5: Low current ideal for battery powered applications.

Specifications (cont'd)

ELECTRICAL OPERATING CHARACTERISTICS (CONT'D)						
Digital Pins ($V_{BUS} = 4.0V$ to $5.5V$; $V_{CC} = 2.5V \pm 0.2V$)						
SYMBOL	PARAMETER	CONDITIONS	MIN	TYP	MAX	UNITS
V_{IL}	Logic LOW input voltage				0.7	V
V_{IH}	Logic HIGH input voltage		1.7			V
V_{OL}	Logic LOW output voltage	$I_{OL} = 100\mu A$ $I_{OL} = 2mA$			0.15	V
					0.40	V
V_{OH}	Logic HIGH output voltage	$I_{OH} = 100\mu A$ $I_{OH} = 2mA$			2.15	V
					1.90	V
Digital Pins ($V_{BUS} = 4.0V$ to $5.5V$; $V_{CC} = 1.65V$ to $3.6V$)						
SYMBOL	PARAMETER	CONDITIONS	MIN	TYP	MAX	UNITS
V_{IL}	Logic LOW input voltage				$0.3 * V_{CC}$	V
V_{IH}	Logic HIGH input voltage		$0.6 * V_{CC}$			V
V_{OL}	Logic LOW output voltage	$I_{OL} = 100\mu A$ $I_{OL} = 2mA$			0.15	V
					0.40	V
V_{OH}	Logic HIGH output voltage	$I_{OH} = 100\mu A$ $I_{OH} = 2mA$			$V_{CC} - 0.15$	V
					$V_{CC} - 0.40$	V
Analog I/O Pins ($V_{BUS} = 4.0V$ to $5.5V$; $V_{CC} = 1.65V$ to $3.6V$)						
SYMBOL	PARAMETER	CONDITIONS	MIN	TYP	MAX	UNITS
V_{DI}	Differential receiver input sensitivity	$ V_{I(D+)} - V_{I(D-)} $	0.2			V
V_{CM}	Differential receiver common mode voltage		0.8		2.5	V
V_{IL}	Single-ended receiver logic LOW input voltage				0.8	V
V_{IH}	Single-ended receiver logic HIGH input voltage		2.0			V
V_{HYS}	Single-ended receiver Hysteresis voltage		0.4		0.7	V
V_{OL}	Logic LOW output voltage	$R_L = 1.5K\Omega$ tied to +3.6V			0.3	V
V_{OH}	Logic HIGH output voltage	$R_L = 15K\Omega$ tied to GND	2.8		3.6	V
I_{LZ}	OFF-state leakage current				± 1	μA
C_{IN}	Transceiver Capacitance	Pin to GND			20	pF
R_{SW}	Internal switch resistance at V_{PU}			50		Ω
Z_{DRV}	Driver output impedance (includes 33 ohm 1% resistor)	Measured with steady-state drive; See Note 6	28	39	44	Ω

Note 6: Rev 2.0 states Z_{DRV} must be between 28Ω and 44Ω when the driver is not high speed capable.

Specifications (cont'd)

ELECTRICAL OPERATING CHARACTERISTICS (CONT'D)						
Driver Characteristics & Timings (Full-speed mode only, SPEED=HIGH)						
SYMBOL	PARAMETER	CONDITIONS	MIN	TYP	MAX	UNITS
t_{FR}	Rise time	$C_L = 50$ to 125 pF, measured 10% to 90% ($V_{OH}-V_{OL}$); See Figure 6	4		20	ns
t_{FF}	Fall time	$C_L = 50$ to 125 pF, measured 10% to 90% ($V_{OH}-V_{OL}$); See Figure 6	4		20	ns
FRFM	Differential rise / fall time matching (t_{FR} / t_{FF})	Excluding the first transition from idle state		100		%
V_{CRS}	Output signal crossover voltage	Excluding the first transition from idle state; See Figure 9		1.65		V
$t_{PLH(DRV)}$	Driver propagation delay ($V_O / V_{PO} \rightarrow D+ / D-$; FSEO / $V_{MO} \rightarrow D+ / D-$)	LOW-to-HIGH transition; See Figure 9			18	ns
$t_{PHL(DRV)}$		HIGH-to-LOW transition; See Figure 9			18	ns
t_{PHZ}	Driver disable delay ($\overline{OE} \rightarrow D+ / D-$)	HIGH-to-OFF; See Figure 7			15	ns
t_{PLZ}		LOW-to-OFF; See Figure 7			15	ns
t_{PZH}	Driver enable delay ($OE \rightarrow D+ / D-$)	OFF-to-HIGH; See Figure 7			15	ns
t_{PZL}		OFF-to-LOW; See Figure 7			15	ns
Driver Characteristics & Timings (Low-speed mode only, SPEED=LOW)						
SYMBOL	PARAMETER	CONDITIONS	MIN	TYP	MAX	UNITS
t_{LR}	Rise time	$C_L = 200$ to 600 pF, measured 10% to 90% ($V_{OH}-V_{OL}$); See Figure 6	75		300	ns
t_{LF}	Fall time	$C_L = 200$ to 600 pF, measured 10% to 90% ($V_{OH}-V_{OL}$); See Figure 6	75		300	ns
FRFM	Differential rise / fall time matching (t_{FR} / t_{FF})	Excluding the first transition from idle state	80		125	%
V_{CRS}	Output signal crossover voltage	Excluding the first transition from idle state; See Figure 9	1.3		2.0	V
Receiver Timings (Full-speed and low-speed modes)						
SYMBOL	PARAMETER	CONDITIONS	MIN	TYP	MAX	UNITS
Differential Receiver						
$t_{PLH(RCV)}$	Driver propagation delay ($D+ / D- \rightarrow RCV$)	LOW-to-HIGH transition; See Figure 8			15	ns
$t_{PHL(RCV)}$		HIGH-to-LOW transition; See Figure 8			15	ns
Single-ended Receiver						
$t_{PLH(SE)}$	Driver propagation delay ($D+ / D- \rightarrow V_P / V_M$)	LOW-to-HIGH transition; See Figure 8			18	ns
$t_{PHL(SE)}$		HIGH-to-LOW transition; See Figure 8			18	ns

Specifications (cont'd)

Test Loads

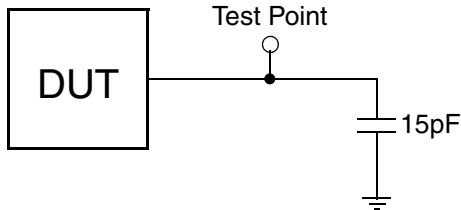

Load for V_P / V_M and RCV delay measurements

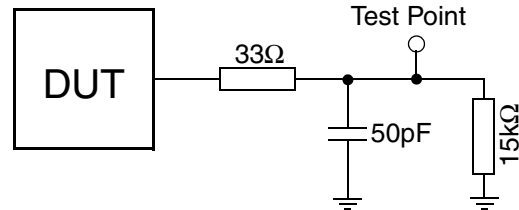

Load for D+ and D- delay measurements (MAX and MIN Timing)

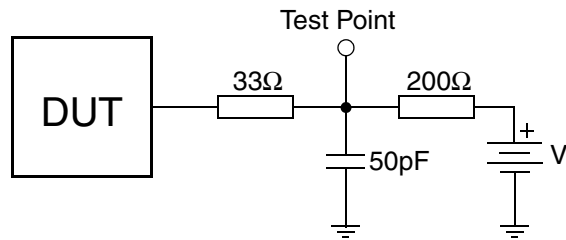

$V = V_{REG}(3.3)$ for t_{PZL} and t_{PLZ}
 $V = 0$ v for t_{PZH} and t_{PHZ}

Load for ENABLE and DISABLE delay measurements.

Performance Information

CM2400-02/03/04 Typical DC Characteristics (nominal conditions unless specified otherwise)

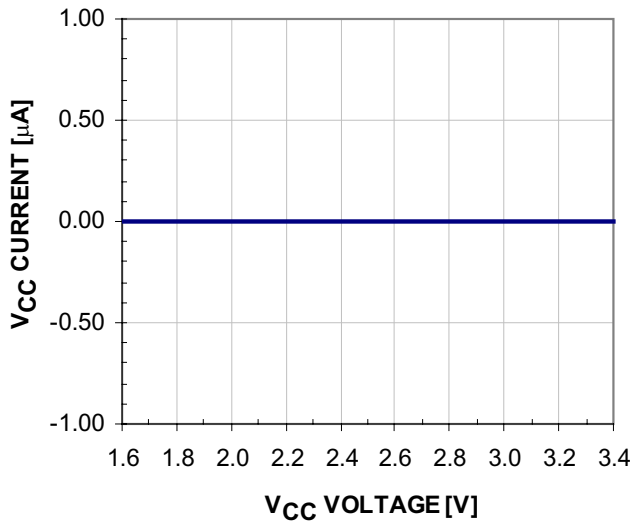

Figure 1. V_{CC} Current in Idle Mode (SPND=LOW)

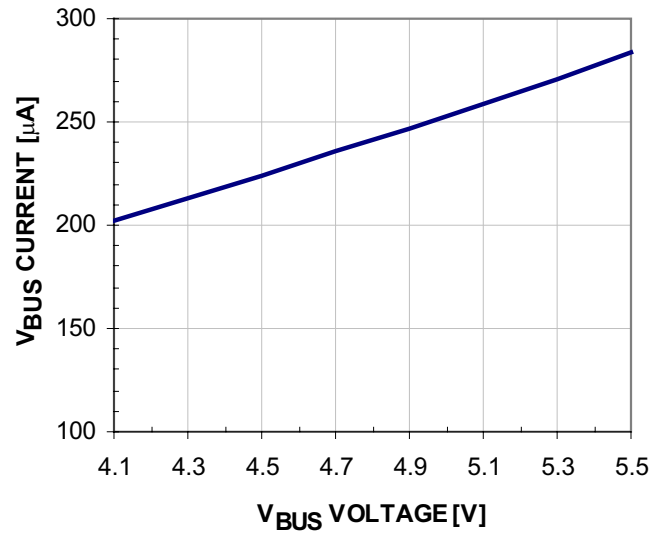

Figure 3. V_{BUS} Current in Idle Mode (SPND=LOW)

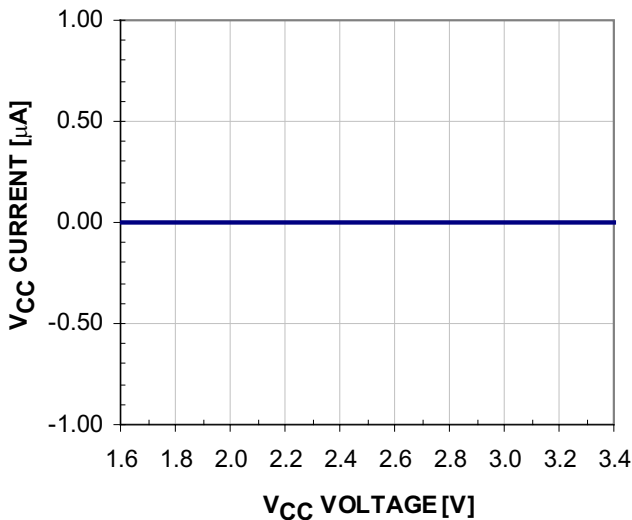

Figure 2. V_{CC} Current in Suspend Mode (SPND=HIGH)

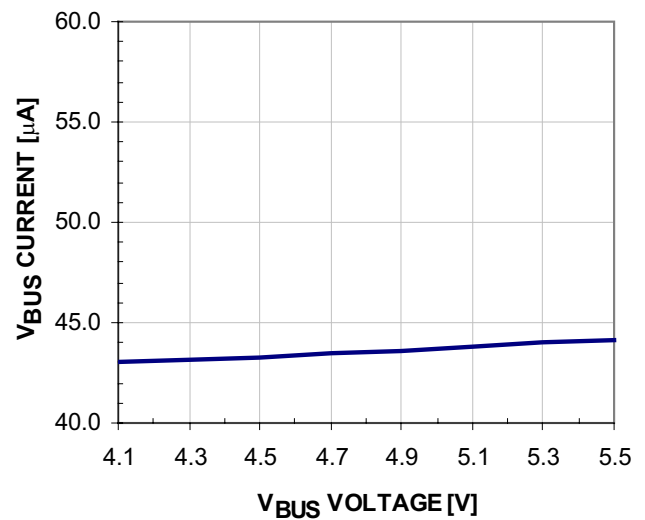

Figure 4. V_{BUS} Current in Suspend Mode (SPND=HIGH)

Performance Information (cont'd)

CM2400-02/03/04 Typical AC Characteristics (nominal conditions unless specified otherwise)

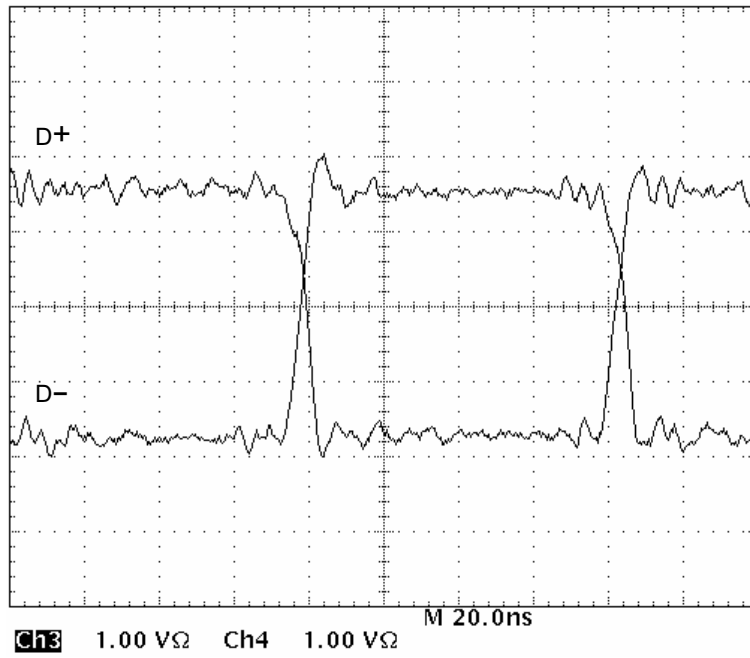

Figure 5. Rise and Fall Time Matching for Full-Speed Mode

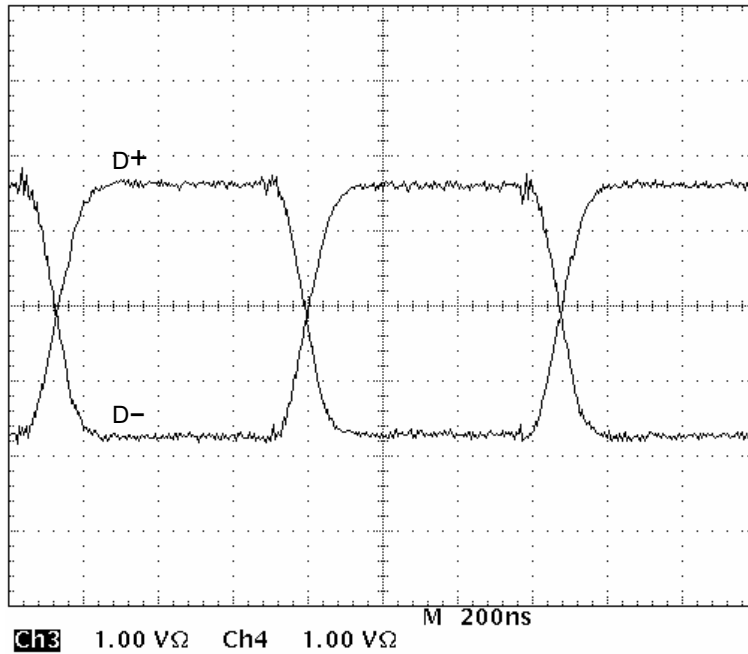

Figure 6. Rise and Fall Time Matching for Low-Speed Mode

Performance Information (cont'd)

CM2400 Timing Diagrams

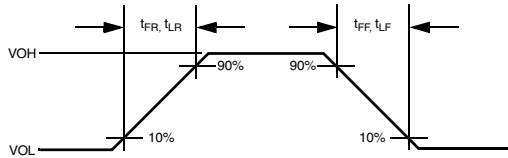

Figure 7. Rise and Fall Timing

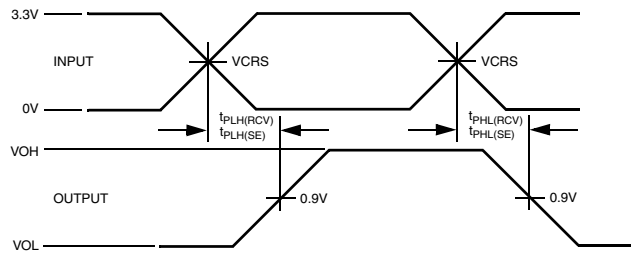

Figure 9. D+, D- to RCV, V_p and V_M Timing

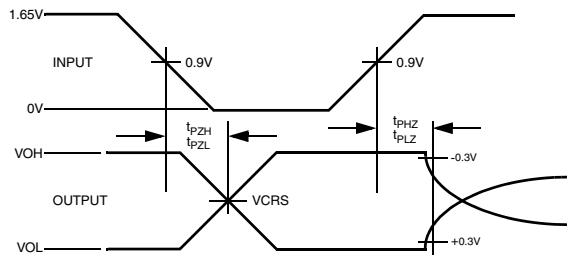

Figure 8. \overline{OE} to D+, D- Timing

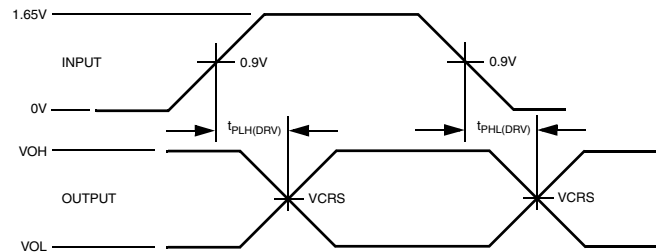

Figure 10. V_O/V_{P0} , F_{SEO}/V_{M0} to D+, D- Timing

Functional Description

The CM2400-02/03/04 USB Transceiver supports 3 different power supply configurations, which can be configured dynamically. [Table 1](#) details the various configurations. In Normal Mode the internal regulator produces 3.3V from V_{BUS} to power the internal drivers and receivers associated with the USB protocol.

V_{BUS}	V_{CC}	CONFIGURATION
Connected	Connected	Normal Mode
Connected	Not Connected	Disable Mode
Not Connected	Connected	Sharing Mode

Table 1: Power Supply Connections

There are three power supply configurations for the CM2400-02/03/04: Normal mode, Disable mode and Sharing mode. These three modes can be changed dynamically.

Normal mode occurs when the V_{CC} and V_{BUS} inputs are both connected to a source. V_{BUS} is tied to a 5V source for 5V operation. The internal regulator of the CM2400-02/03/04 provides 3.3V output on V_{REG} . The V_{CC} input is connected to an independent source that can range from 1.65V to 3.6V.

When V_{CC} is not connected and V_{BUS} is connected, the device is in Disable mode. The D+ and D- pins are in tri-state and power consumption drops to a suspend state level.

In Sharing mode, V_{CC} is connected while V_{BUS} is below 3.6V. The D+ and D- pins are in tri-state and the CM2400-02/03/04 allows external signals ($\leq 3.6V$) to share these two lines. The CM2400-02/03/04 is designed to draw almost zero current from the D+ and

D- lines while in sharing mode. In this mode, V_P and V_M are driven high while RCV and USB_DET are driven low.

In Disable and Sharing Mode, all input/output pins follow the states defined in [Table 2](#).

PIN	Sharing Mode State	Disable Mode State
V_{BUS}	$V_{BUS} < 3.6V$	4.1V to 5.5V
V_{REG}	Pulled Down	3.3V Out
V_{CC}	Present	Not Present
V_{PU}	High-Z (off)	High-Z (off)
D+, D-	High-Z	High-Z
V_P, V_M	H	Invalid
RCV	L	Invalid
USB_DET	L	Invalid
Inputs	High-Z	High-Z

Table 2: Pin States in Disable or Sharing Mode

[Table 3](#) lists the functions of the modes associated with suspend and \overline{OE} pins. When Suspend is low and \overline{OE} is high, signal levels on D+ and D- are determined by other USB devices and pull-up/down resistors. In Suspend Mode (SPND = HIGH) the differential receiver is inactive and output RCV is always LOW. Out of suspend signaling is detected via the single-ended receivers V_P and V_M . During suspend and while the output is still enabled ($\overline{OE} = \text{LOW}$), D+ and D- lines are driven to their intended states.

SUSPEND	\overline{OE}	D+ / D-	RCV	V_P/V_M	Function
L	L	Driver & Receiver Active	Active	Active	Normal driving mode. Differential receiver active
L	H	Receiving	Active	Active	Driver Tri-stated. Differential receiver active.
H	L	Driving	Inactive RCV=L	Active	Driving during 'suspend'. Differential receiver inactive.
H	H	High-Z	Inactive RCV=L	Active	Low-power state.

Table 3: Function Selection.

Functional Description (cont'd)

Detailed in [Table 4](#) and [Table 5](#) are the operating modes for the CM2400-02/03/04. The CM2400-02 features a fixed, single-ended input operating mode which is summarized in [Table 4](#). The CM2400-03 features a differential-pair input operating mode which is summarized in [Table 5](#). The CM2400-04 input mode is selectable via the MODE input. [Table 4](#) and [Table 5](#) summarize both operating modes for the CM2400-04.

On the CM2400-02, the two driver inputs function as V_O and FSE0 inputs. On the CM2400-03, the driver inputs function as V_{PO} and V_{MO} . On the CM2400-04, when the MODE input is HIGH, differential-pair input mode is selected and the two driver inputs function as V_{PO} and V_{MO} . When MODE is LOW, the single-ended input data interface mode is selected and the two driver inputs function as V_O and FSE0.

MODE	V_O (V_{PO})	FSE0 (V_{MO})	Result
L (single-ended)	L	L	Logic '0'
	L	H	SE0
	H	L	Logic '1'
	H	H	SE0

Table 4: Single-ended Input Operating Mode, CM2400-02 and CM2400-04 in Single-ended Input Mode ($\overline{OE} = L$)

MODE	V_O (V_{PO})	FSE0 (V_{MO})	Result
H (differential)	L	L	SE0
	L	H	Logic '0'
	H	L	Logic '1'
	H	H	Undefined

Table 5: Differential-pair Input Operating Mode, CM2400-03 and CM2400-04 in Differential-pair Input Mode ($\overline{OE} = L$)

[Table 6](#) details the receiving function when \overline{OE} is HIGH (driver disabled). RCV denotes the signal level on the output RCV just before an SE0 state occurs. This level is stable during the SE0 period.

D+/D-	RCV	V_P	V_M
Differential Logic '0'	L	L	H
Differential Logic '1'	H	H	L
SE0	RCV*	L	L

* Denotes RCV is stable in last state before SE0 condition.

Table 6: Receiving Function (SPND = L)

A regulator bypass option can be utilized by shorting VBUS to VREG and connecting to a 3.3v supply.

Mechanical Details

The CM2400-02/03/04 family is available in a 16-lead HBCC and 16-lead TSSOP packages. The mechanical details for these packages are presented below.

HBCC-16 Mechanical Specifications

Dimensions for the CM2400-02HB, CM2400-03HB and CM2400-04HB devices packaged in 16-pin HBCC packages are presented below.

PACKAGE DIMENSIONS				
Package	HBCC-16			
Pins	16			
Dimensions	Millimeters		Inches	
	Min	Max	Min	Max
A	-	0.80		0.0315
A ₁	0.05	0.10		0.0039
b ₁	0.25	0.35		0.0138
b ₂	0.30	0.40		0.0157
b ₃	0.30	0.40		0.0157
D	2.90	3.10		0.1220
D _h	1.45	1.55		0.0610
E	2.90	3.10		0.1220
E _h	1.75	1.85		0.0728
e	0.50 TYP.		0.0197 TYP.	
e ₁	2.50 TYP.		0.0984 TYP.	
e ₂	2.50 TYP.		0.0984 TYP.	
e ₃	2.45 TYP.		0.0965 TYP.	
e ₄	2.45 TYP.		0.0965 TYP.	
# per tube	120 pieces*			
# per tape and reel	2500 pieces			
Controlling dimension: millimeters				

* This is an approximate number which may vary.

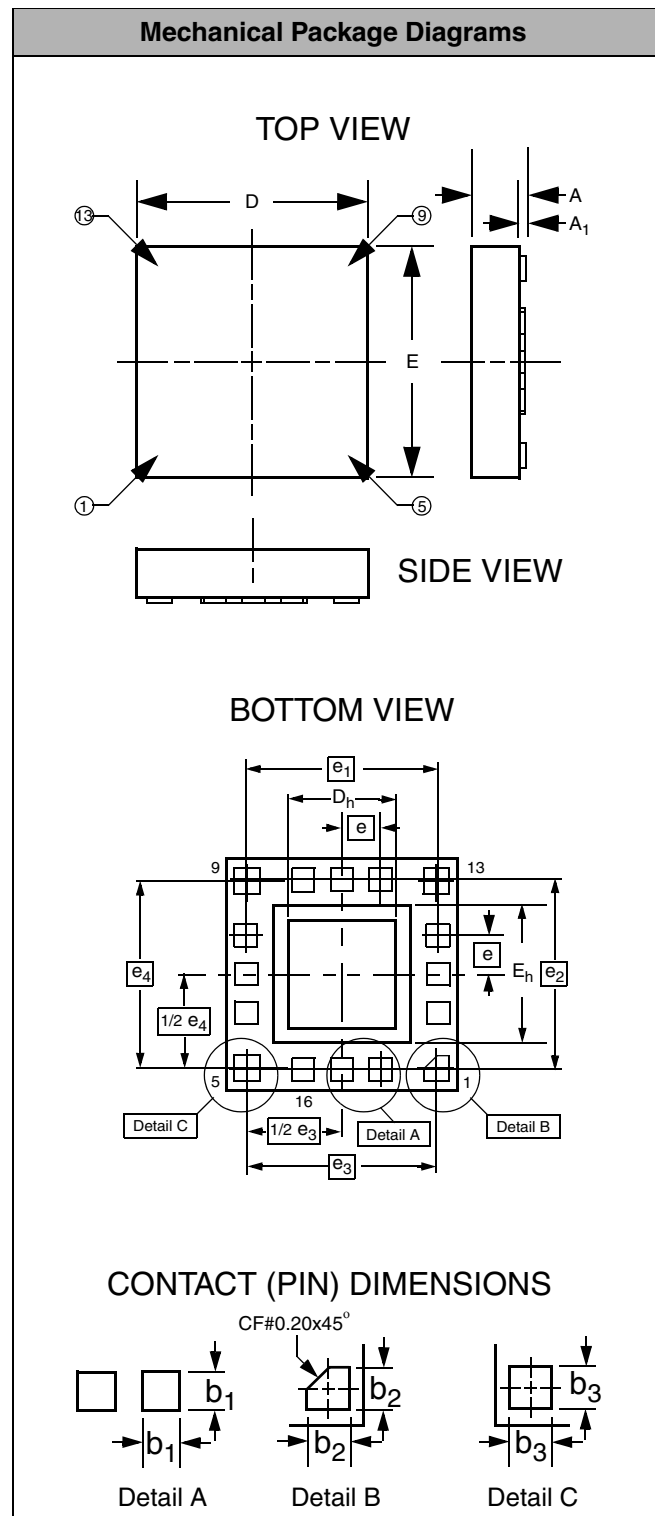

Dimensions for HBCC-16 Package

Mechanical Details (cont'd)

TSSOP-16 Mechanical Specifications

Dimensions for the CM2400-02TS and CM2400-03TS devices packages are presented below.

For complete information on the TSSOP-16 package, see the California Micro Devices TSSOP Package Information document.

PACKAGE DIMENSIONS				
Package	TSSOP			
Pins	16			
Dimensions	Millimeters		Inches	
	Min	Max	Min	Max
A	—	1.10	—	0.0433
A1	0.05	0.15	0.002	0.006
B	0.19	0.30	0.0075	0.0118
C	0.09	0.20	0.0035	0.0079
D	4.90	5.10	0.193	0.201
E	4.30	4.50	0.169	0.177
e	0.65 BSC		0.0256 BSC	
H	6.25	6.50	0.246	0.256
L	0.50	0.70	0.020	0.028
# per tube	Consult Factory			
# per tape and reel	2500 pcs			
Controlling dimension: millimeters				

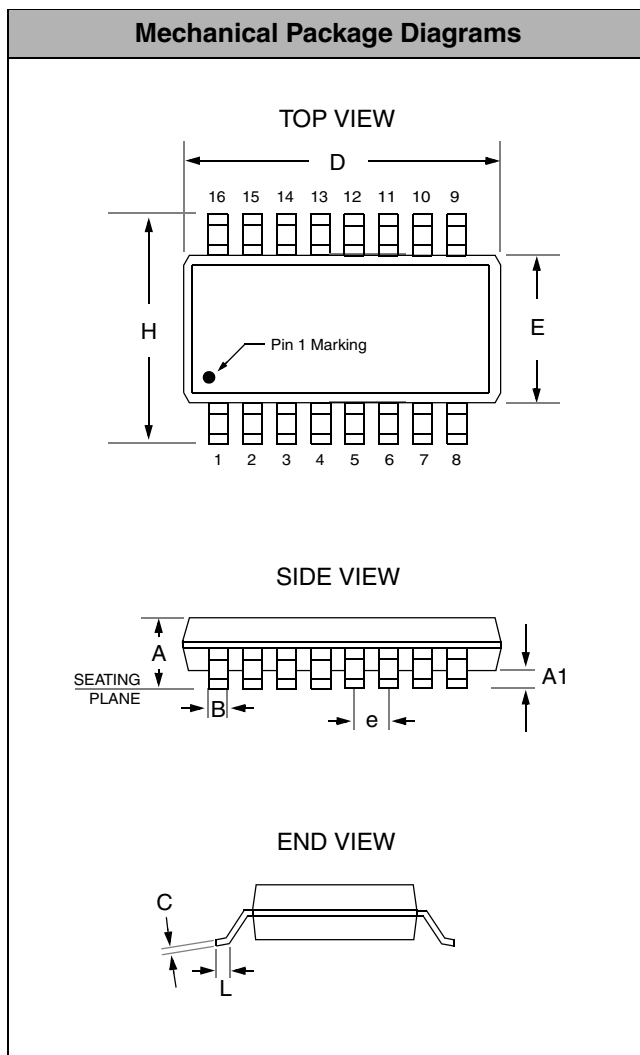

Dimensions for the TSSOP-16 Package