



# LA1835

## Home Stereo Single-Chip Tuner IC with Electronic Tuning Support

### Overview

The LA1835 is an AM, FM IF and MPX single-chip tuner IC that supports electronic tuning. It was developed specifically for use in home stereo products and is optimal for products with auto-seek systems, since it combines SD and IF counting in its auto-seek implementation. Furthermore, since the FM detector and MPX VCO circuits are adjustment free, adoption of the LA1835 can reduce the number of adjustment steps in the production line.

### Functions

- AM: RF amplifier, mixer, oscillator (with ALC), IF amplifier, detector, AGC, oscillator buffer, tuning indicator (narrow-band SD), IF buffer output, stereo IF output
- FM IF: IF amplifier, quadrature detector, band muting, tuning indicator, IF buffer output, S-meter
- MPX: PLL stereo decoder, stereo indicator, forced mono, VCO stop function, adjacent channel interference rejection function (114 kHz), post-amplifier with muting function

### Features

- Significant reduction in the number of manufacturing adjustment steps
  - FM detector: Adjustment free (using a ceramic discriminator)
  - MPX VCO: Adjustment free (using a ceramic resonator)
- Tuning indicator output provided. (This pin can also be used as a narrow band stop signal and as a muting drive output.)
- Adjustable FM stop sensitivity and bandwidth
- Built-in AM local oscillator buffer

- Support for AM low band cut control
- Adjustable AM stop sensitivity

### Package Dimensions

unit: mm

#### 3196-DIP30SD

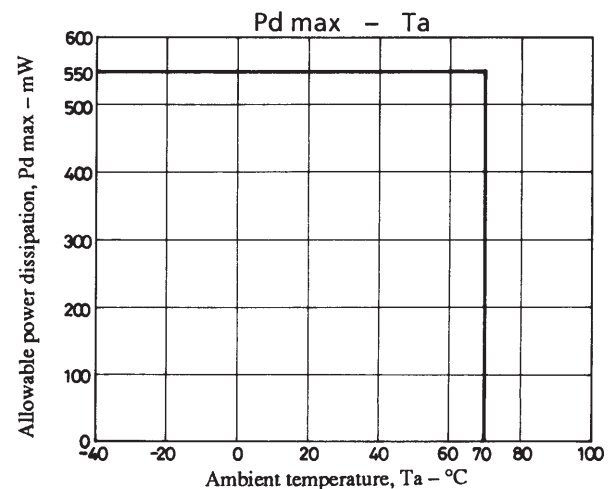
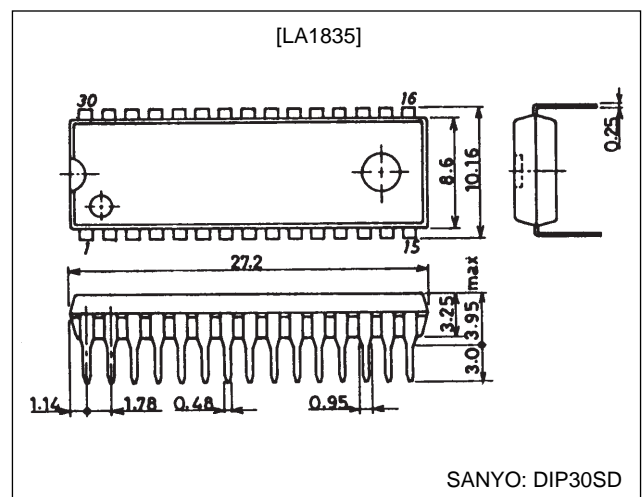

■ Any and all SANYO products described or contained herein do not have specifications that can handle applications that require extremely high levels of reliability, such as life-support systems, aircraft's control systems, or other applications whose failure can be reasonably expected to result in serious physical and/or material damage. Consult with your SANYO representative nearest you before using any SANYO products described or contained herein in such applications.

■ SANYO assumes no responsibility for equipment failures that result from using products at values that exceed, even momentarily, rated values (such as maximum ratings, operating condition ranges, or other parameters) listed in products specifications of any and all SANYO products described or contained herein.

**SANYO Electric Co., Ltd. Semiconductor Business Headquarters**

TOKYO OFFICE Tokyo Bldg., 1-10, 1 Chome, Ueno, Taito-ku, TOKYO, 110-8534 JAPAN

## Specifications

### Maximum Ratings at $T_a = 25^\circ\text{C}$

Parameter	Symbol	Conditions	Ratings	Unit
Maximum supply voltage	$V_{CC}$ max		9.0	V
Allowable power dissipation	$P_d$ max	$T_a \leq 70^\circ\text{C}$	550	mA
Operating temperature	$T_{opr}$		-20 to +70	$^\circ\text{C}$
Storage temperature	$T_{stg}$		-40 to +125	$^\circ\text{C}$

### Operating Conditions at $T_a = 25^\circ\text{C}$

Parameter	Symbol	Conditions	Ratings	Unit
Recommended supply voltage	$V_{CC}$		7.0	V
Operating supply voltage	$V_{CC}$ op		6.5 to 8.5	V

### Operating Characteristics

at  $T_a = 25^\circ\text{C}$ ,  $V_{CC} = 7.0$  V, in the specified test circuit using the IC59-3004 socket (Yamaichi Electric Co., Ltd.)

Parameter	Symbol	Conditions	min	typ	max	Unit
[FM Characteristics (mono): $f_c = 10.7$ MHz, $f_m = 1$ kHz]						
Quiescent current	$I_{CCO-FM}$	No input	23	37	46	mA
Demodulator output	$V_{O-FM}$	100 dB $\mu$ , 100% modulation, the pin 16 output	665	1000	1330	mVrms
Channel balance (monaural)	C. B-mono	100 dB $\mu$ , 100% modulation, pin 16 output/pin 17 output	-1.5	0	+1.5	dB
Total harmonic distortion	THD-FM	100 dB $\mu$ , 100% modulation, the pin 16 output		0.3	1.5	%
Signal-to-noise ratio	S/N-FM	100 dB $\mu$ , 100% modulation, the pin 16 output	67	74		dB
AM suppression ratio	AMR	100 dB $\mu$ , 30% AM modulation, the pin 16 output	35	50		dB
Input limiting voltage	-3dBLS	100 dB $\mu$ , referenced to 100%, with the input down 3 dB		27	35	dB $\mu$
SD indicator sensitivity	SD-on-FM		47	57	67	dB $\mu$
SD indicator bandwidth	SD-BW	100 dB $\mu$	120	190	280	kHz
IF counter buffer output	$V_{IF}$ Buff-FM	100 dB $\mu$ , the pin 11 output	80	120	160	mVrms
S-meter output	$V_{SM-FM}$ (1)	0 dB $\mu$ , the pin 12 output	0	0.3	1.0	V
	$V_{SM-FM}$ (2)	60 dB $\mu$ , the pin 12 output	0.7	1.5	2.5	V
	$V_{SM-FM}$ (3)	100 dB $\mu$ , the pin 12 output	2.5	4.0	5.0	V
Muting attenuation	Mute-Att	100 dB $\mu$ , 100% modulation, the pin 16 output	80	95		dB
[FM Characteristics (stereo): $f_c = 10.7$ MHz, $f_m = 1$ kHz, L + R = 90%, pilot = 10%, $V_{IN} = 100$ dB $\mu$ ]						
Separation-left	Sep-L	Left channel modulated; pin 17 output/pin 16 output	30	45		dB
Separation-right	Sep-R	Right channel modulated; pin 16 output/pin 17 output	30	45		dB
Stereo on level	ST-on	The pilot modulation such that $V_7 < 0.7$ V	1.8	3.6	6.0	%
Stereo off level	ST-off	The pilot modulation such that $V_7 > 4.5$ V		2.5		%
Total harmonic distortion (main)	THD-main	The pin 16 output		0.3	1.5	%
Channel balance (main)	C. B-main	Pin 16 output/pin 17 output	-1.5	0	+1.5	dB
Capture range	C. R.	Pilot = 10%		$\pm 1.5$		%
Adjacent channel rejection ratio	B. Rej	$f_s = 113$ kHz, $V_S = 90\%$ , pilot = 10%, the pin 16 output		40		dB
[AM Characteristics: $f_c = 1000$ kHz, $f_m = 1$ kHz]						
Quiescent current	$I_{CCO-AM}$	No input	21	29	42	mA
Detector output	$V_{O-AM}$ (1)	23 dB $\mu$ , 30% modulation, the pin 16 output	25	45	90	mVrms
	$V_{O-AM}$ (2)	80 dB $\mu$ , 30% modulation, the pin 16 output	195	310	490	mVrms
Signal-to-noise ratio	S/N-AM (1)	23 dB $\mu$ , 30% modulation, the pin 16 output	16	20		dB
	S/N-AM (2)	80 dB $\mu$ , 30% modulation, the pin 16 output	48	54		dB
Total harmonic distortion	THD-AM (1)	80 dB $\mu$ , 30% modulation, the pin 16 output		0.3	1.0	%
	THD-AM (2)	100 dB $\mu$ , 30% modulation, the pin 16 output		0.4	1.2	%
	THD-AM (3)	80 dB $\mu$ , 80% modulation, the pin 16 output		1.0	4.0	%
SD indicator sensitivity	SD-on-AM		20	30	40	dB $\mu$
Local oscillator buffer output	$V_{OSC-AM}$	No input, the pin 30 output	110	160		mVrms
Low-band attenuation	Low-Cut	The output for $f_m = 100$ Hz referenced to $f_m = 1$ kHz	5.0	7.0	11.0	dB
IF counter buffer output	$V_{IF}$ Buff-AM	80 dB $\mu$ , unmodulated signal, the pin 11 output	140	200	280	mVrms
Stereo IF output	$V_{STIF-AM}$	80 dB $\mu$ , unmodulated signal, the pin 8 output	8.0	17.0	24.0	mVrms
S-meter output	$V_{SM-AM}$ (1)	0 dB $\mu$ , unmodulated signal	0	0	0.2	V
	$V_{SM-AM}$ (2)	40 dB $\mu$ , unmodulated signal	1.3	3.0	4.5	V

Sample Application Circuit

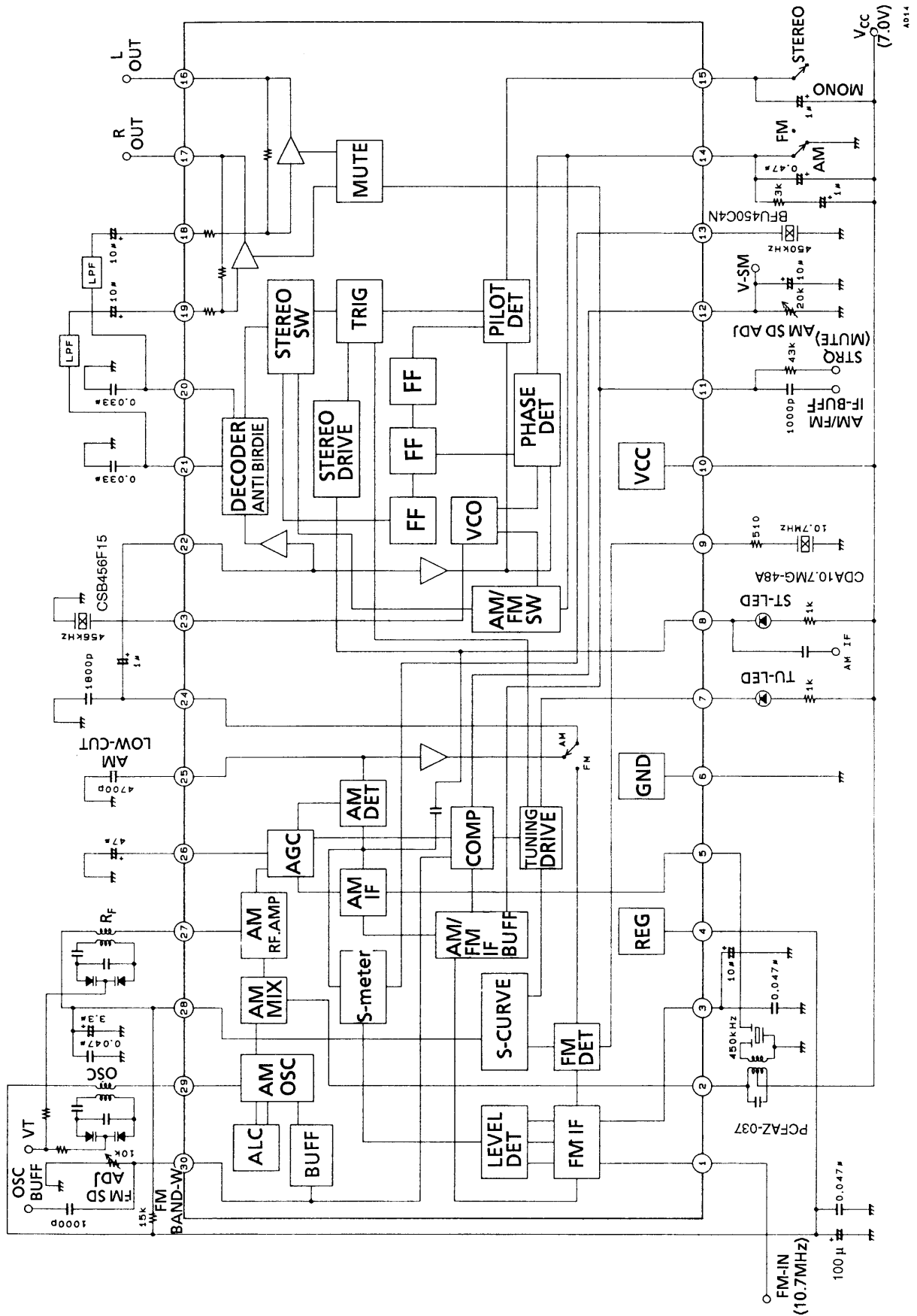

Unit (resistance: Ω, capacitance: F)



LA1835

Pin Functions

No.	Function	Voltage	Internal equivalent circuit	Note
1	FM IF input	Vreg	<p>A01486</p>	Input impedance: $r_i = 330 \Omega$
2	AM mixer output	V <sub>CC</sub>	<p>A01487</p>	Recommended AM IFT coil: PCFAZ-037 (Toko Co., Ltd.)
3	FM IF input bypass	Vreg	<p>A01486</p>	Also used for the AF noise filter.
4	REG	Vreg	<p>A01488</p>	Vreg = 3.6 V
5	AM IF input	Vreg	<p>A01489</p>	Input impedance: $r_i = 2 \text{ k}\Omega$
6	GND	0		
7	Tu-LED	V <sub>CC</sub>	<p>A01490</p>	Active low open collector outputs Pin 8 is used for the AM stereo IF output.
8	ST-LED	V <sub>CC</sub>		
9	FM detector	2.1 (FM) 2.7 (AM)	<p>A01491</p>	Recommended ceramic discriminator: CDA 10.7MG-48 (Murata Mfg. Co., Ltd.)

Continued on next page.

## LA1835

Continued from preceding page.

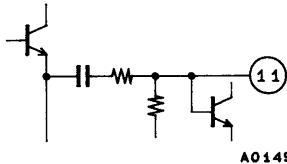
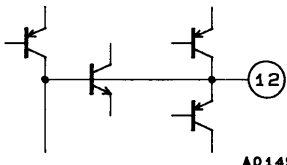
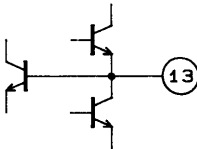
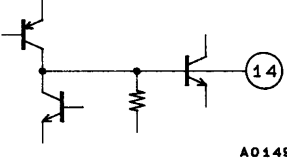
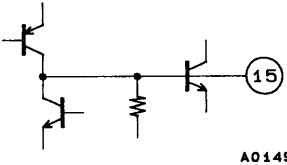
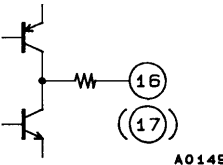
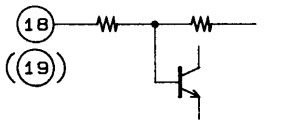
No.	Function	Voltage	Internal equivalent circuit	Note
10	$V_{CC}$	$V_{CC}$		
11	AM/FM IF buffer output Also functions as the output control switch (muting switch).	0	 A01492	A voltage of 1.3 V or higher turns on the post-amplifier output muting. A voltage of 4.0 V or higher turns on the IF buffer output. The recommended control voltage for turning muting on is 1.9 V.
12	S-meter output Also functions as the AM SD sensitivity adjustment.	0.3 (FM) 0 (AM)	 A01493	The AM SD sensitivity can be adjusted with the resistor inserted between this pin and ground. Since the FM SD sensitivity is affected by this resistor, the AM SD sensitivity must be adjusted first.
13	AM narrow band ceramic filter connection	1.5	 A01494	Recommended narrow band ceramic filter: BFU450 C4N (Murata Mfg. Co., Ltd.)
14	Phase comparator low-pass filter (FM/AM switch)	$V_{CC} - 1.4$ (FM) 0 (AM)	 A01495	The LA1835 switches to AM mode when this pin is connected to ground.
15	Pilot detector low-pass filter (forced mono) (VCO stop)	$V_{CC} - 1.0$	 A01496	If a current of 50 $\mu$ A or larger flows from this pin, the LA1835 switches to mono mode. The VCO is stopped if this pin is connected to ground.
16 17	Post-amplifier left and right outputs	$V_{reg}$ $V_{reg}$	 A01497	Output impedance: $r_o = 200 \Omega$ Pin 16: left output Pin 17: right output
18 19	Post-amplifier left and right inputs	$V_{reg}$ $V_{reg}$	 A01498	Inverting inputs, $r_i = 3.3 k\Omega$ Pin 18: left input Pin 19: right input

Continued on next page.

## LA1835

Continued from preceding page.

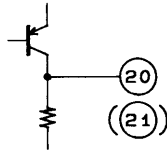
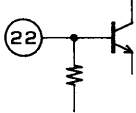
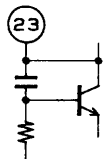
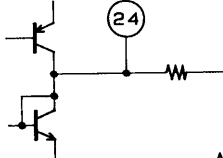
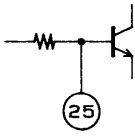
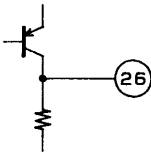
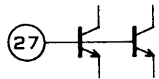
No.	Function	Voltage	Internal equivalent circuit	Note
20 21	MPX outputs Left and right outputs	3.5 3.5	 <p style="text-align: center;"><b>A01499</b></p>	Output impedance $r_o = 3.3 \text{ k}\Omega$ Pin 20: left de-emphasis Pin 21: right de-emphasis
22	MPX input	2.9	 <p style="text-align: center;"><b>A01500</b></p>	Input impedance $r_i = 20 \text{ k}\Omega$ Increasing the value of the external capacitor connected between this pin and pin 24 improves the low frequency separation characteristics. However, the impulse noise associated with switching between AM and FM also increases.
23	MPX VCO	3.5 (FM) 0 (AM)	 <p style="text-align: center;"><b>A01501</b></p>	Recommended ceramic oscillator: CSB456F15 (Murata Mfg. Co., Ltd.)
24	AM/FM demodulator output	2.9 (FM) 3.0 (AM)	 <p style="text-align: center;"><b>A01502</b></p>	Output impedances FM: $r_o = 250 \Omega$ AM: $r_o = 10 \text{ k}\Omega$ The separation can be adjusted by changing the value of the external capacitor connected between this pin and ground.
25	AM low cut	2.9 (FM) 3.0 (AM)	 <p style="text-align: center;"><b>A01503</b></p>	The low-band frequency characteristics of the AF demodulator can be adjusted by changing the value of the external capacitor connected between this pin and ground. The AM detector output can be attenuated by adding a resistor in series with the capacitor.
26	AMAGC	0 (FM) 0.5 (AM)	 <p style="text-align: center;"><b>A01504</b></p>	The internal load resistance, R is $6.7 \text{ k}\Omega$ .
27	AM RF input	Vreg	 <p style="text-align: center;"><b>A01505</b></p>	Pin 27 must be used at the same voltage as pin 4, the regulator voltage.

Continued on next page.

LA1835

Continued from preceding page.

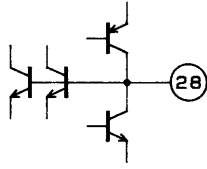
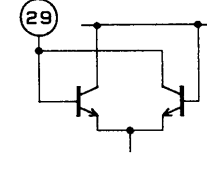
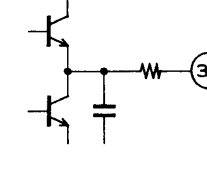
No.	Function	Voltage	Internal equivalent circuit	Note
28	AFC	Vreg	 <p>A01506</p>	The FM SD bandwidth can be adjusted by changing the value of the external resistor inserted between pin 28 and pin 4, the regulator voltage.
29	OSC	Vreg	 <p>A01507</p>	The oscillator coil is connected between pin 29 and pin 4, the regulator voltage.
30	Oscillator buffer output Also functions as the FM SD sensitivity adjustment.	1.6 (FM) 1.3 (AM)	 <p>A01508</p>	The FM SD sensitivity can be adjusted by changing the value of the external resistor inserted between this pin and ground. The AM SD sensitivity must be adjusted before the AM FD sensitivity. Output impedance $r_o = 200 \Omega$

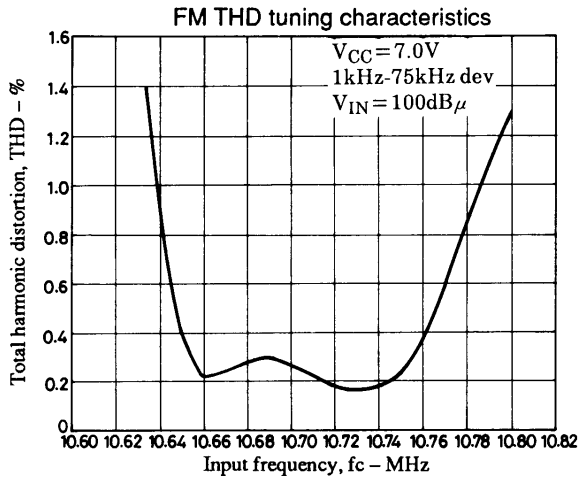
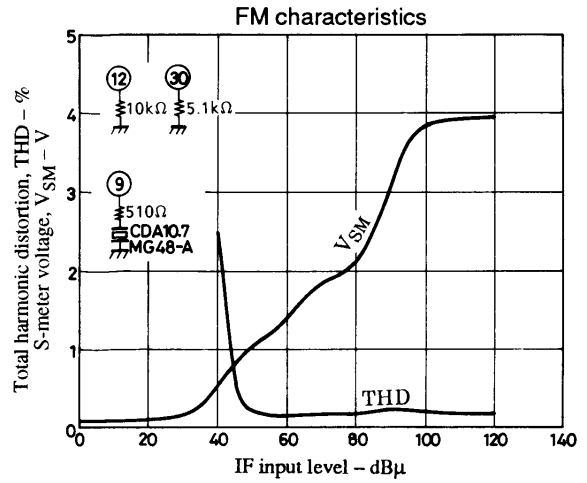
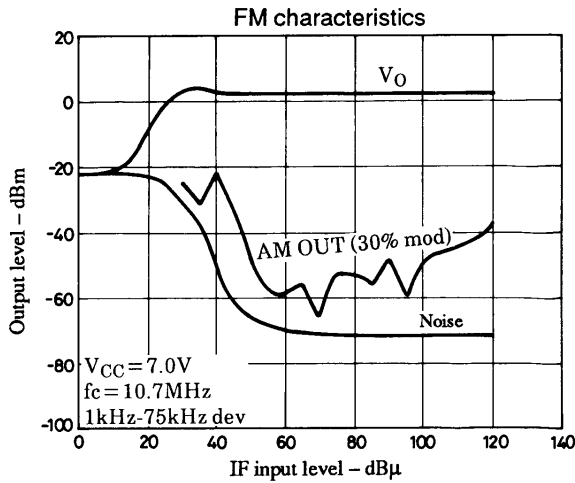



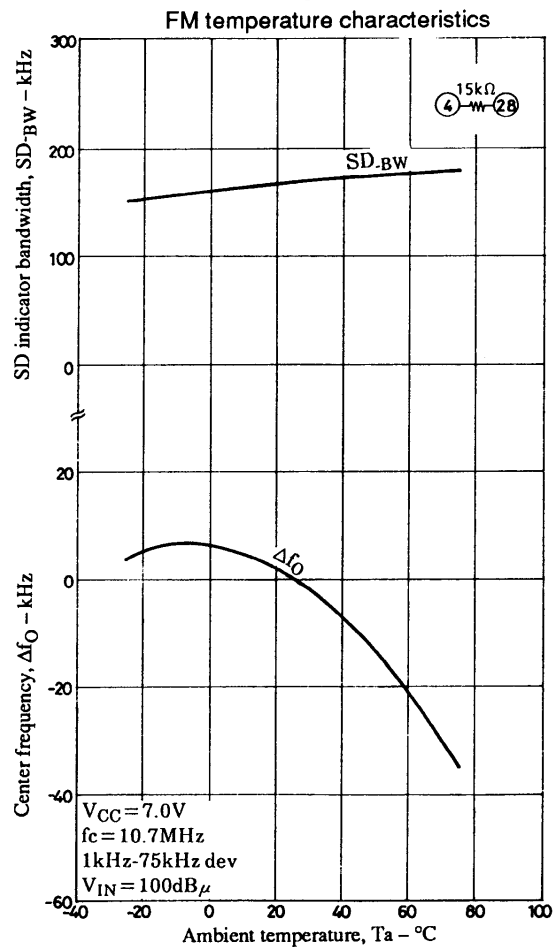
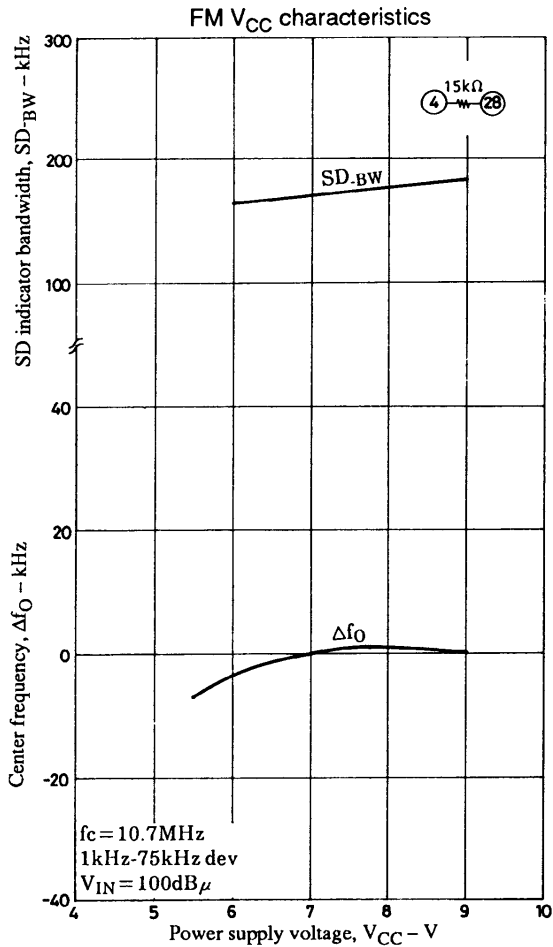
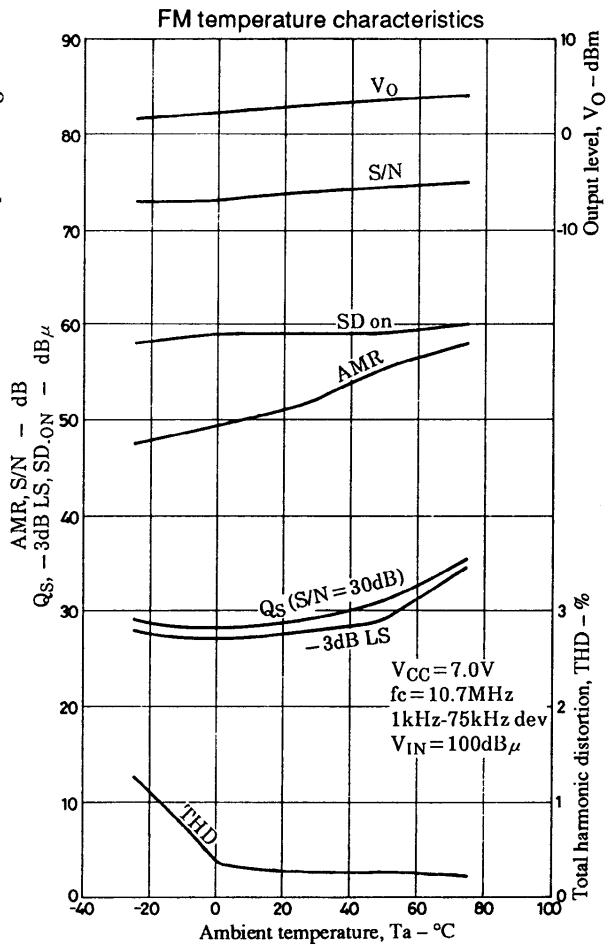
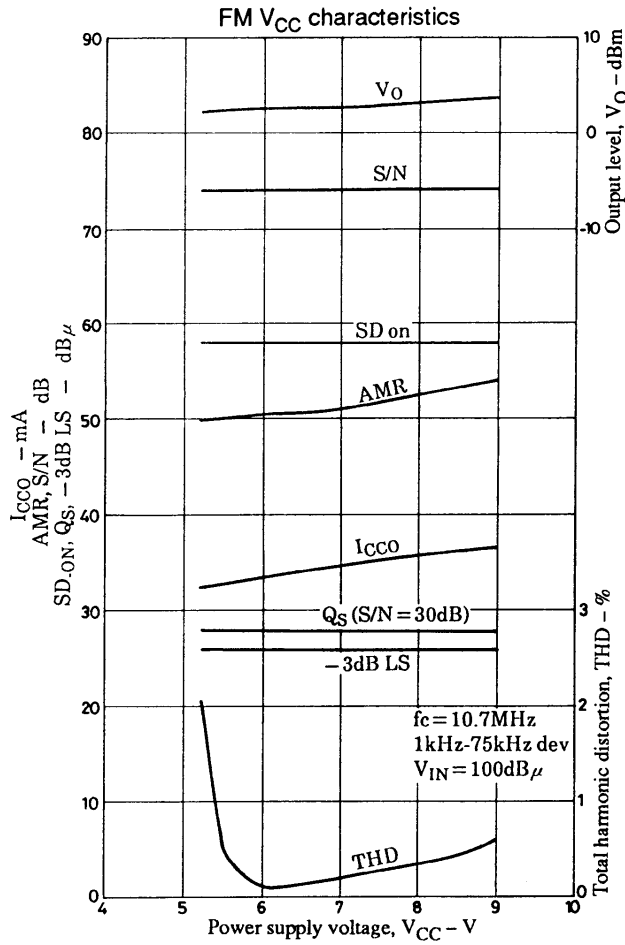

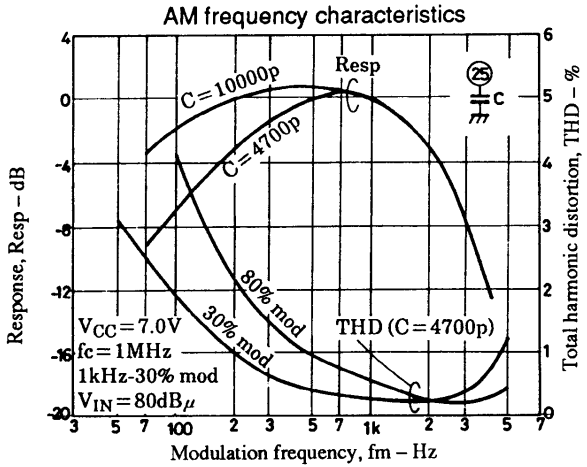
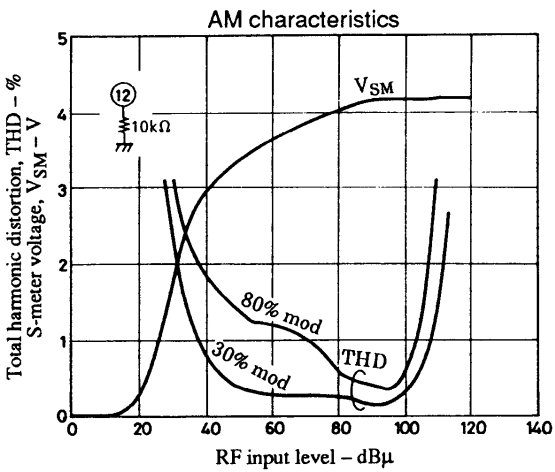
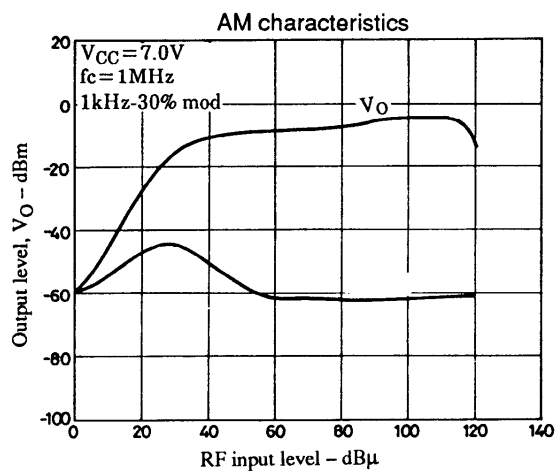
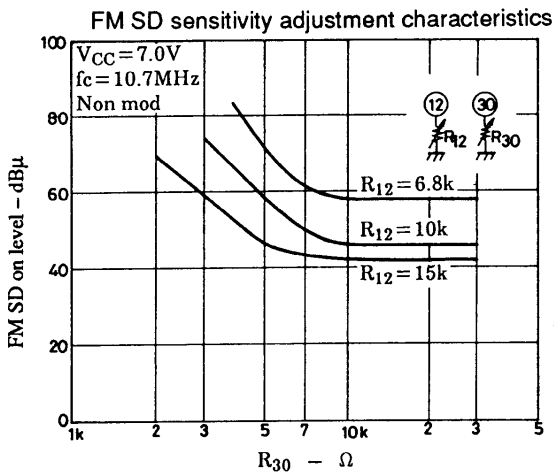
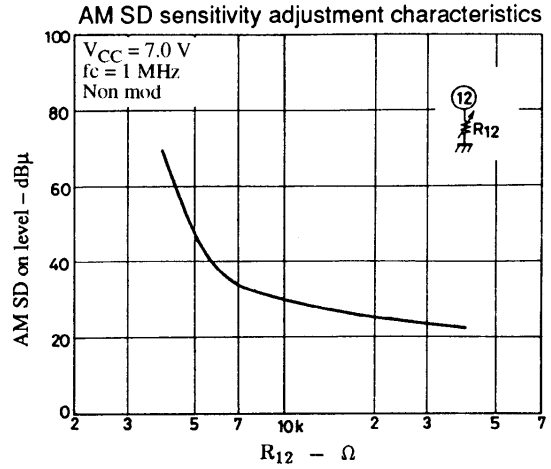
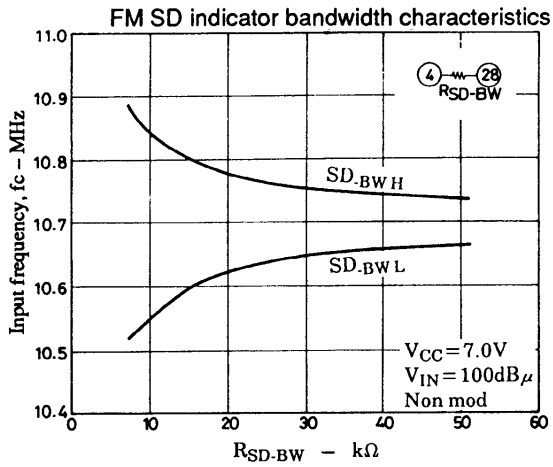

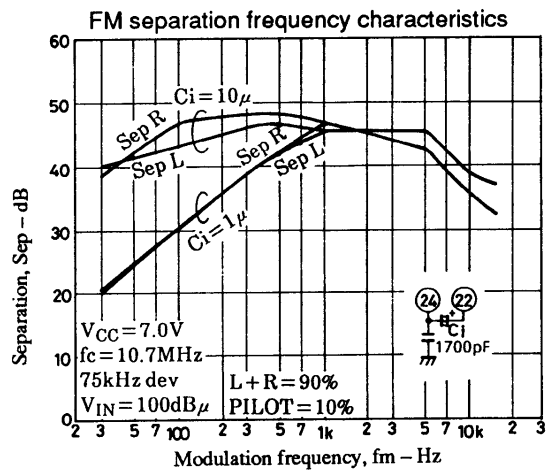
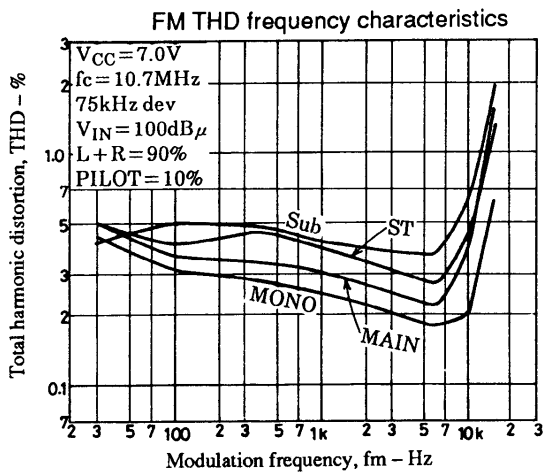
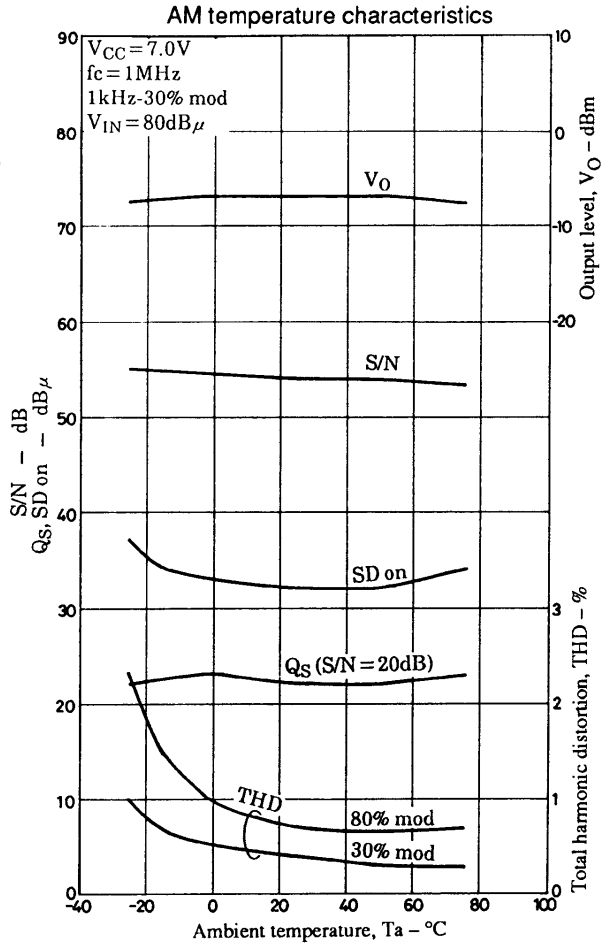
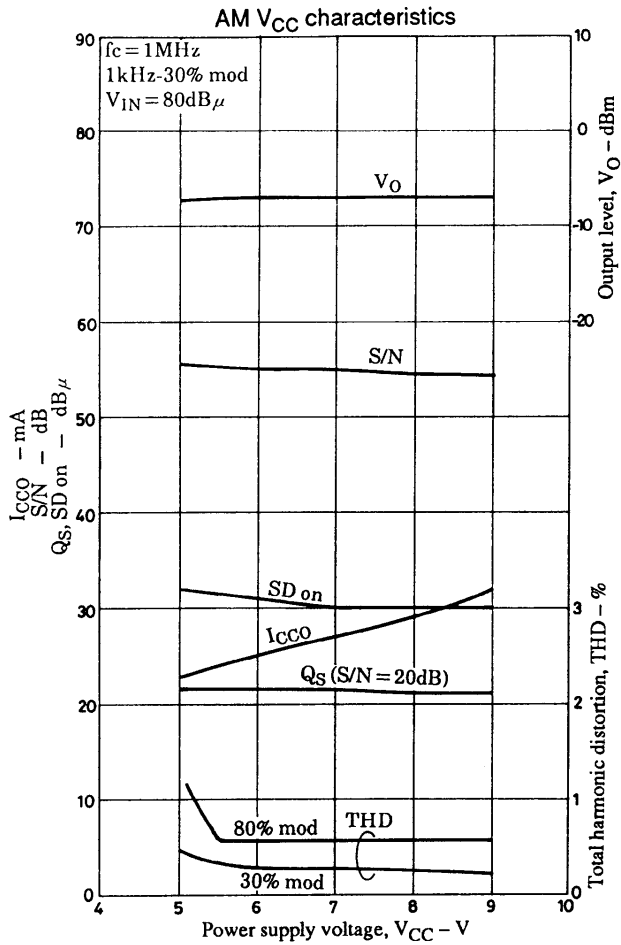

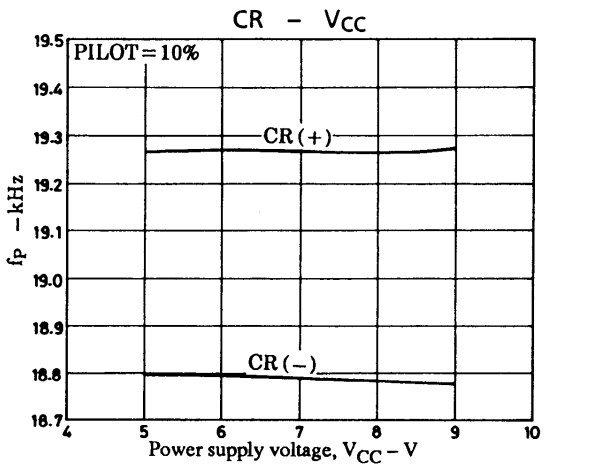
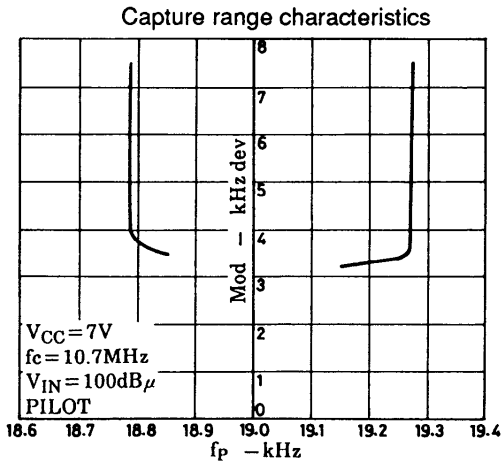
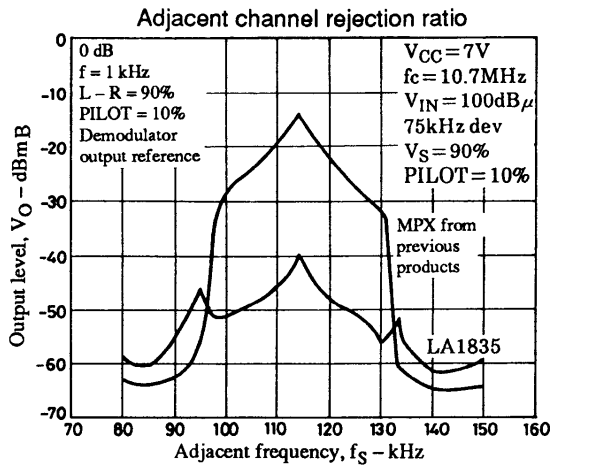
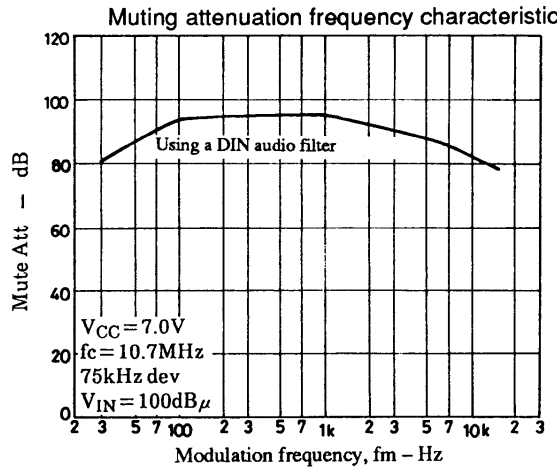
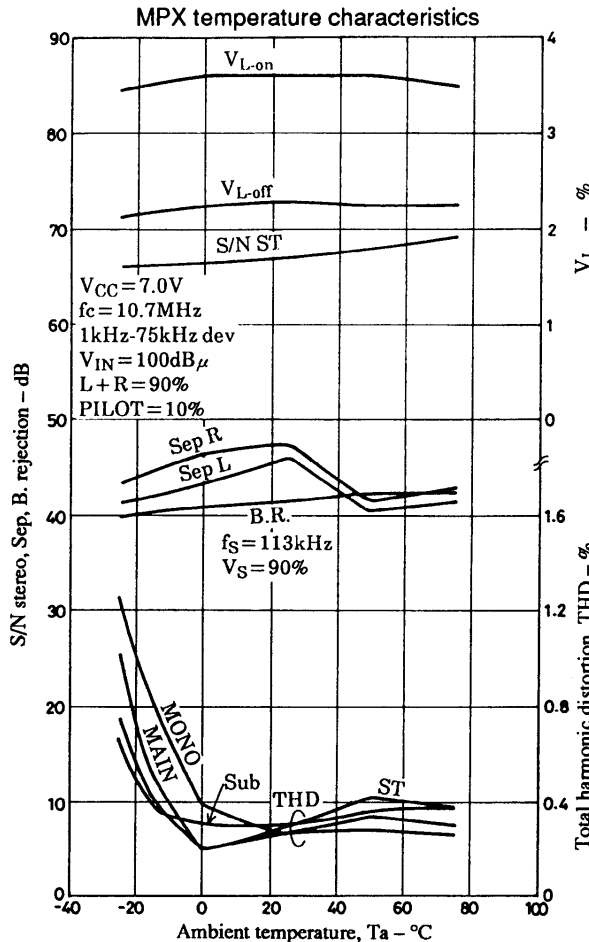
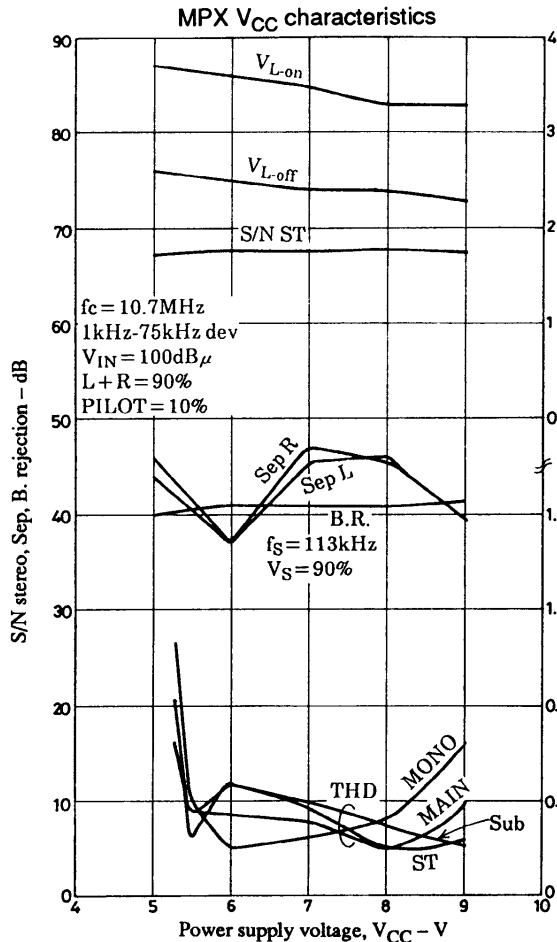

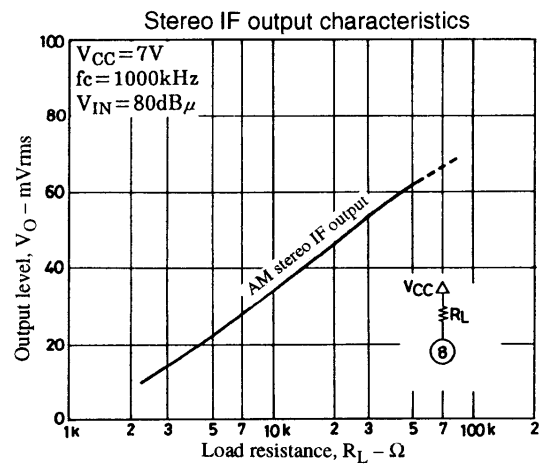
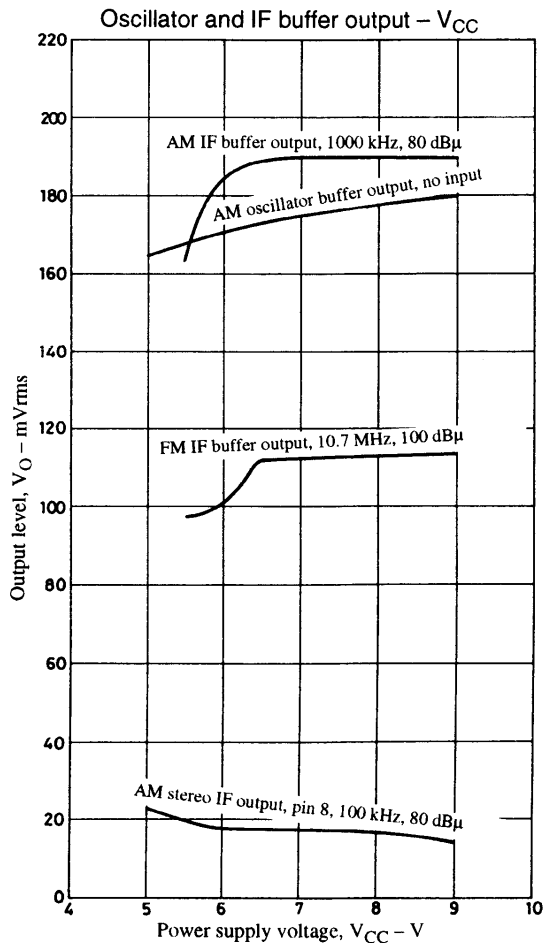
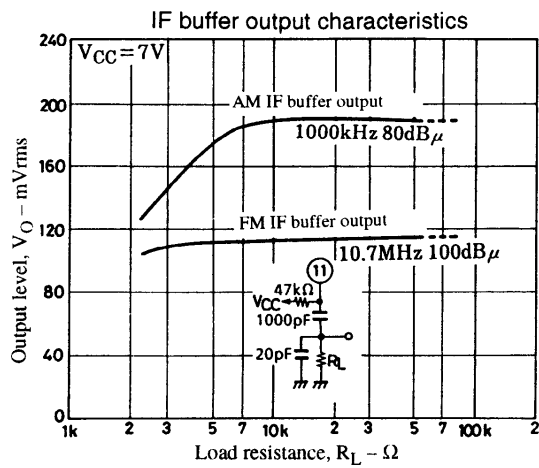
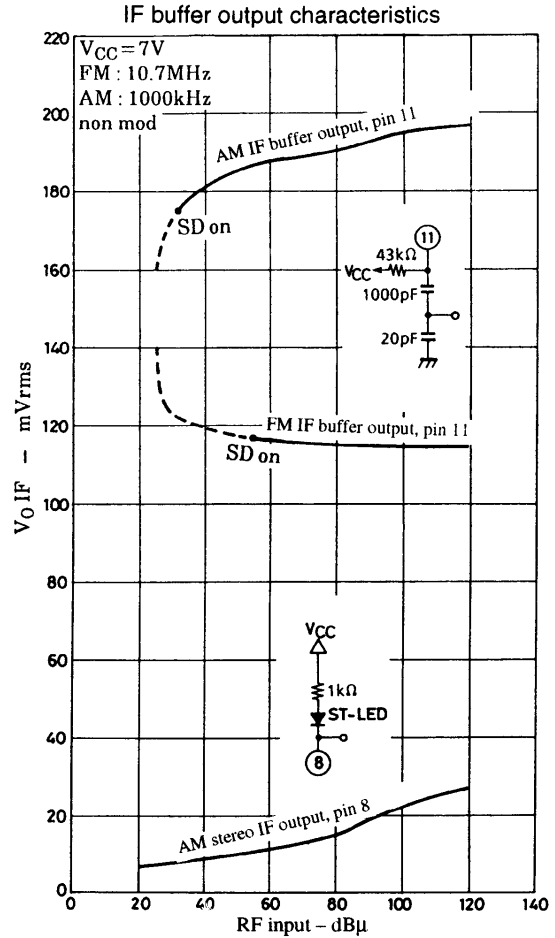
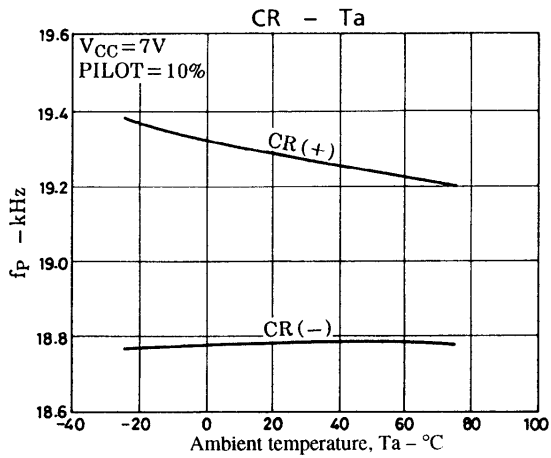

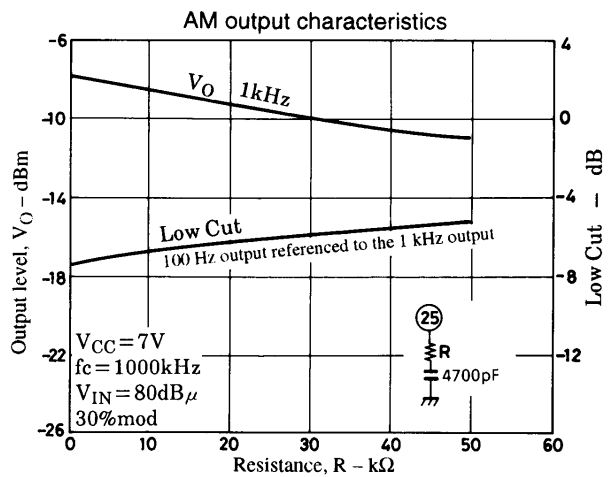
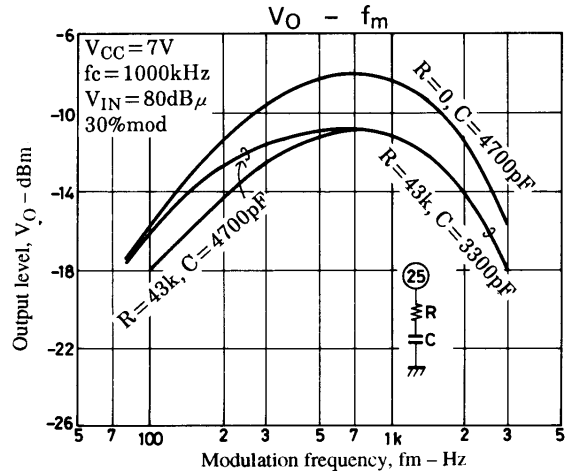
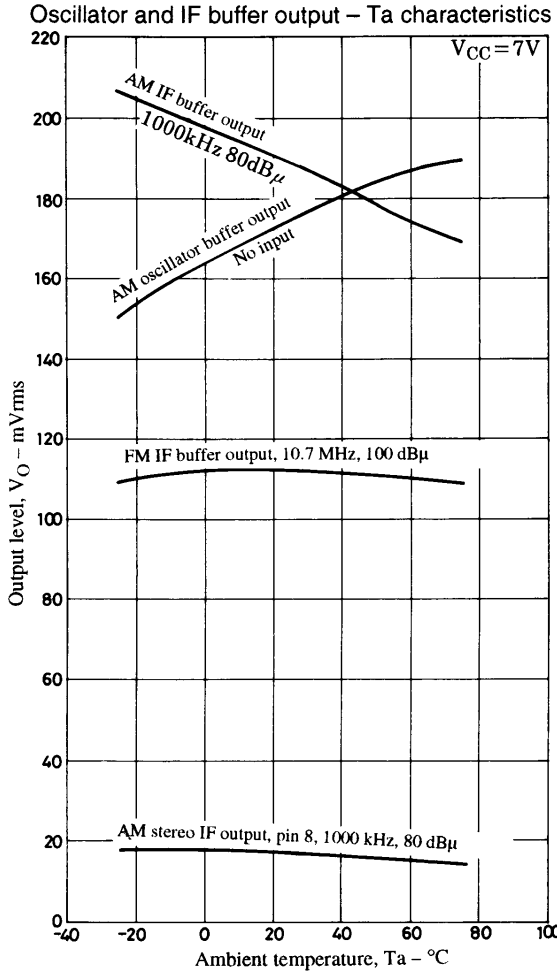

- Specifications of any and all SANYO products described or contained herein stipulate the performance, characteristics, and functions of the described products in the independent state, and are not guarantees of the performance, characteristics, and functions of the described products as mounted in the customer's products or equipment. To verify symptoms and states that cannot be evaluated in an independent device, the customer should always evaluate and test devices mounted in the customer's products or equipment.
- SANYO Electric Co., Ltd. strives to supply high-quality high-reliability products. However, any and all semiconductor products fail with some probability. It is possible that these probabilistic failures could give rise to accidents or events that could endanger human lives, that could give rise to smoke or fire, or that could cause damage to other property. When designing equipment, adopt safety measures so that these kinds of accidents or events cannot occur. Such measures include but are not limited to protective circuits and error prevention circuits for safe design, redundant design, and structural design.
- In the event that any and all SANYO products described or contained herein fall under strategic products (including services) controlled under the Foreign Exchange and Foreign Trade Control Law of Japan, such products must not be exported without obtaining export license from the Ministry of International Trade and Industry in accordance with the above law.
- No part of this publication may be reproduced or transmitted in any form or by any means, electronic or mechanical, including photocopying and recording, or any information storage or retrieval system, or otherwise, without the prior written permission of SANYO Electric Co., Ltd.
- Any and all information described or contained herein are subject to change without notice due to product/technology improvement, etc. When designing equipment, refer to the "Delivery Specification" for the SANYO product that you intend to use.
- Information (including circuit diagrams and circuit parameters) herein is for example only; it is not guaranteed for volume production. SANYO believes information herein is accurate and reliable, but no guarantees are made or implied regarding its use or any infringements of intellectual property rights or other rights of third parties.

This catalog provides information as of August, 1998. Specifications and information herein are subject to change without notice.