

N-Channel MOSFET

N-Channel MOSFET

Features

High ruggedness

$R_{DS(on)}$ (Max 5.5)@ $V_{GS}=10V$

Gate Charge (Typical 15nC)

Improved dv/dt Capability

100% Avalanche Tested

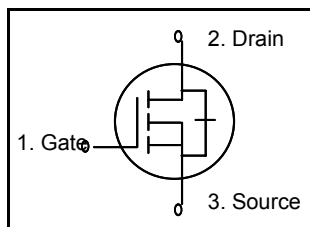

$BV_{DSS} = 600V$

$R_{DS(ON)} = 5.5 \text{ ohm}$

$I_D = 2.1A$

General Description

This N-channel enhancement mode field-effect power transistor using DI semiconductor's advanced planar stripe, DMOS technology intended for off-line switch mode power supply.

Also, especially designed to minimize $r_{ds(on)}$ and high rugged avalanche characteristics. The D-PAK pkg is well suited for charger SMPS and small power inverter application.

D-PAK

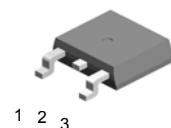

Absolute Maximum Ratings

Symbol	Parameter	Value	Units
V_{DSS}	Drain to Source Voltage	600	V
I_D	Continuous Drain Current(@ $T_C = 25^\circ C$)	2.1	A
	Continuous Drain Current(@ $T_C = 100^\circ C$)	1.3	A
I_{DM}	Drain Current Pulsed (Note 1)	8.0	A
V_{GS}	Gate to Source Voltage	± 30	V
E_{AS}	Single Pulsed Avalanche Energy (Note 2)	148	mJ
E_{AR}	Repetitive Avalanche Energy (Note 1)	4.5	mJ
dv/dt	Peak Diode Recovery dv/dt (Note 3)	4.5	V/ns
P_D	Total Power Dissipation(@ $T_C = 25^\circ C$)	45	W
	Derating Factor above $25^\circ C$	0.36	W/ $^\circ C$
T_{STG}, T_J	Operating Junction Temperature & Storage Temperature	- 55 ~ 150	$^\circ C$
T_L	Maximum Lead Temperature for soldering purpose, 1/8 from Case for 5 seconds.	300	$^\circ C$

Thermal Characteristics

Symbol	Parameter	Value			Units
		Min.	Typ.	Max.	
$R_{\theta JC}$	Thermal Resistance, Junction-to-Case	-	-	2.78	$^\circ C/W$
$R_{\theta CS}$	Thermal Resistance, Case to Sink	-	-	50	$^\circ C/W$
$R_{\theta JA}$	Thermal Resistance, Junction-to-Ambient	-	-	110	$^\circ C/W$

DFD2N60

Electrical Characteristics (T_C = 25 °C unless otherwise noted)

Symbol	Parameter	Test Conditions	Min	Typ	Max	Units
Off Characteristics						
BV _{DSS}	Drain-Source Breakdown Voltage	V _{GS} = 0V, I _D = 250uA	600	-	-	V
BV _{DSS} / T _J	Breakdown Voltage Temperature coefficient	I _D = 250uA, referenced to 25 °C	-	0.4	-	V/°C
I _{DSS}	Drain-Source Leakage Current	V _{DS} = 600V, V _{GS} = 0V	-	-	10	uA
		V _{DS} = 480V, T _C = 125 °C	-	-	100	uA
I _{GSS}	Gate-Source Leakage, Forward	V _{GS} = 30V, V _{DS} = 0V	-	-	100	nA
	Gate-source Leakage, Reverse	V _{GS} = -30V, V _{DS} = 0V	-	-	-100	nA
On Characteristics						
V _{GS(th)}	Gate Threshold Voltage	V _{DS} = V _{GS} , I _D = 250uA	2.0	-	4.0	V
R _{DS(ON)}	Static Drain-Source On-state Resistance	V _{GS} = 10 V, I _D = 1.0A	-	4.5	5.5	
Dynamic Characteristics						
C _{iss}	Input Capacitance	V _{GS} = 0 V, V _{DS} = 25V, f = 1MHz	-	570	720	pF
C _{oss}	Output Capacitance		-	150	215	
C _{rss}	Reverse Transfer Capacitance		-	310	450	
Dynamic Characteristics						
t _{d(on)}	Turn-on Delay Time	V _{DD} = 300V, I _D = 2.0A, R _G = 25 see fig. 13. (Note 4, 5)	-	15	35	ns
t _r	Rise Time		-	75	140	
t _{d(off)}	Turn-off Delay Time		-	30	60	
t _f	Fall Time		-	35	60	
Q _g	Total Gate Charge	V _{DS} = 480V, V _{GS} = 10V, I _D = 2.0A see fig. 12. (Note 4, 5)	-	15	20	nC
Q _{gs}	Gate-Source Charge		-	1.6	-	
Q _{gd}	Gate-Drain Charge(Miller Charge)		-	6	-	

Source-Drain Diode Ratings and Characteristics

Symbol	Parameter	Test Conditions	Min.	Typ.	Max.	Unit.
I _S	Continuous Source Current	Integral Reverse p-n Junction Diode in the MOSFET	-	-	2.0	A
I _{SM}	Pulsed Source Current		-	-	8.0	
V _{SD}	Diode Forward Voltage	I _S = 2.0A, V _{GS} = 0V	-	-	1.4	V
t _{rr}	Reverse Recovery Time	I _S = 2.0A, V _{GS} = 0V, di/dt = 100A/us	-	600	-	ns
Q _{rr}	Reverse Recovery Charge		-	1.1	-	uC

NOTES

1. Repeativity rating : pulse width limited by junction temperature
2. L = 68mH, I_{AS} = 2.0A, V_{DD} = 50V, R_G = 50 , Starting T_J = 25°C
3. I_{SD} 2.0, di/dt 300A/us, V_{DD} BV_{DSS}, Starting T_J = 25°C
4. Pulse Test : Pulse Width 300us, Duty Cycle 2%
5. Essentially independent of operating temperature.

DFD2N60

Fig 1. On-State Characteristics

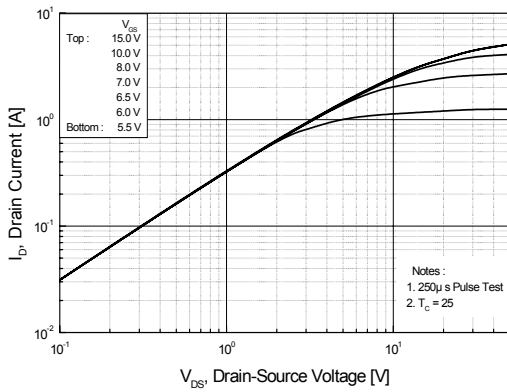

Fig 2. Transfer Characteristics

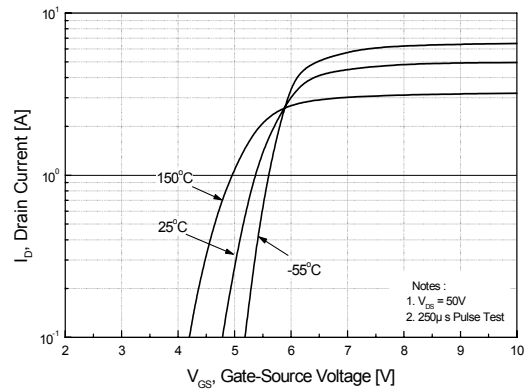

Fig 3. On Resistance Variation vs. Drain Current and Gate Voltage

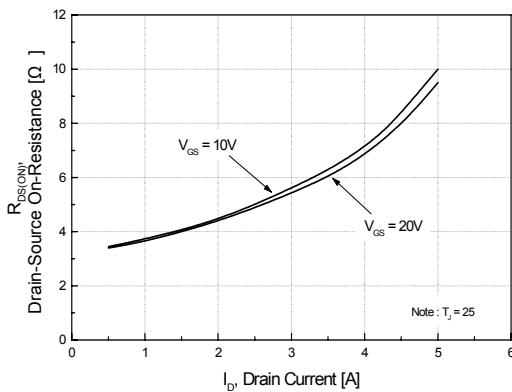

Fig 4. On State Current vs. Allowable Case Temperature

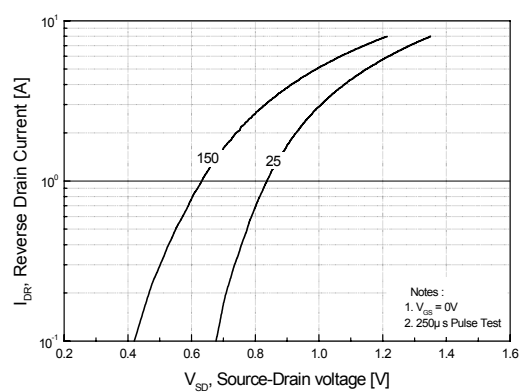

Fig 5. Capacitance Characteristics (Non-Repetitive)

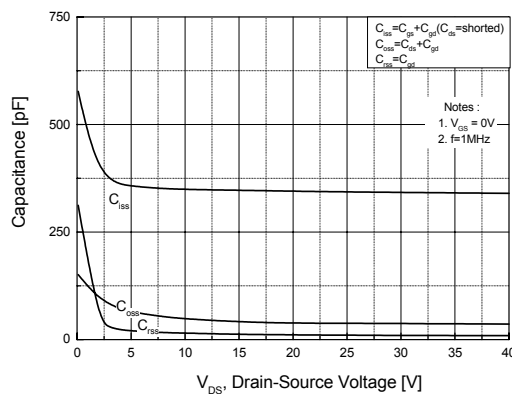
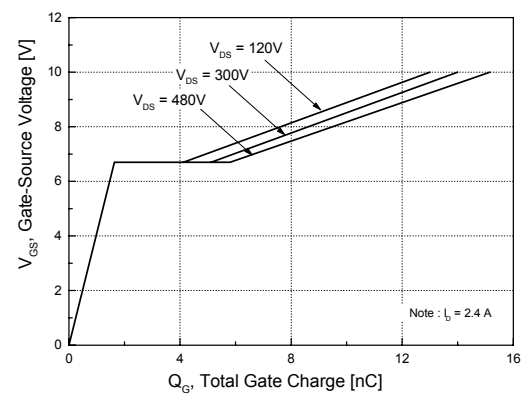

Fig 6. Gate Charge Characteristics



DFD2N60

Fig 7. Breakdown Voltage Variation vs. Junction Temperature

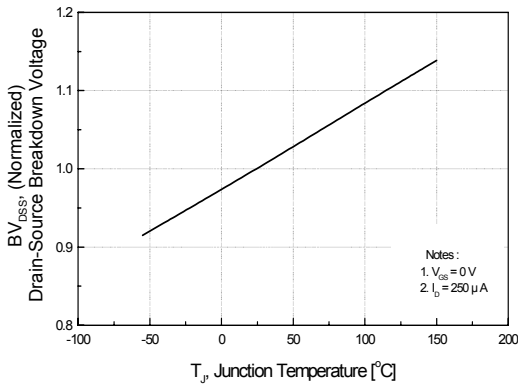

Fig 8. On-Resistance Variation vs. Junction Temperature

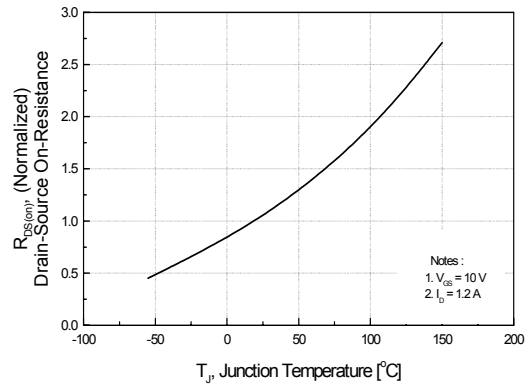

Fig 9. Maximum Safe Operating Area

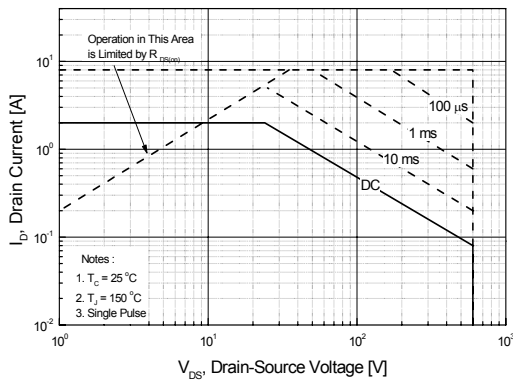

Fig 10. Maximum Drain Current

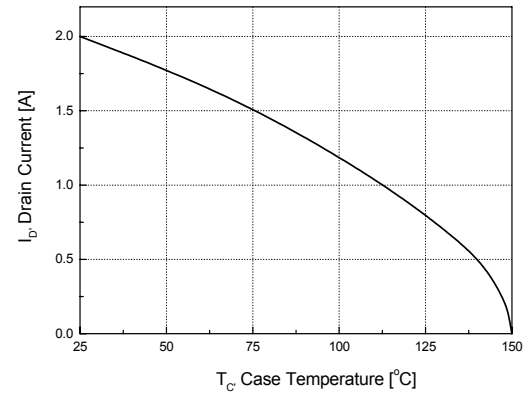
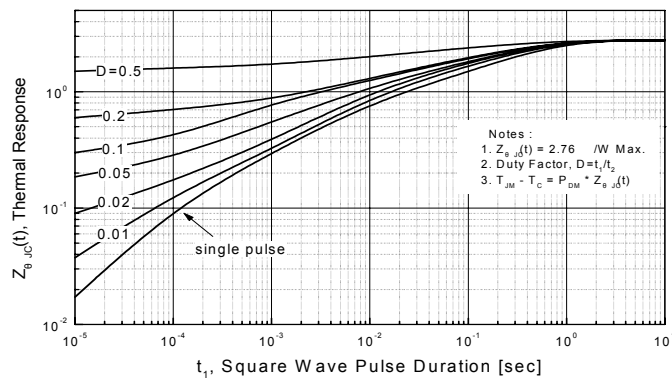

Fig 11. Transient Thermal Response Curve



DFD2N60

Fig. 12. Gate Charge Test Circuit & Waveforms

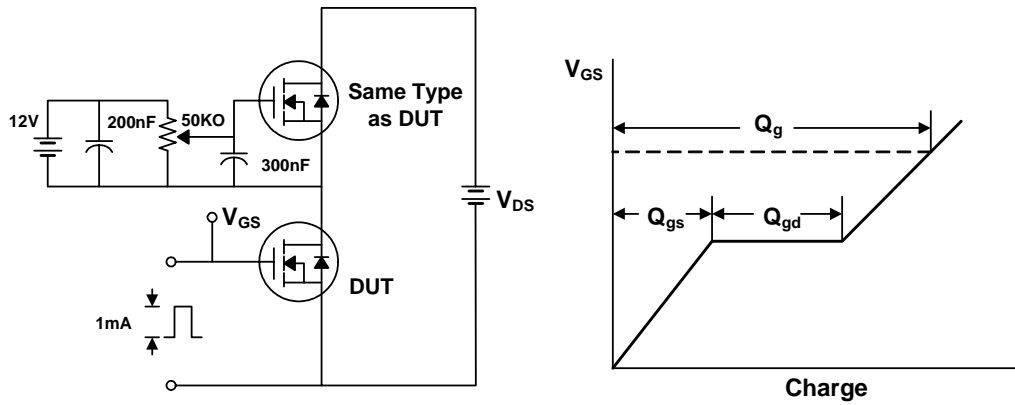

Fig 13. Switching Time Test Circuit & Waveforms

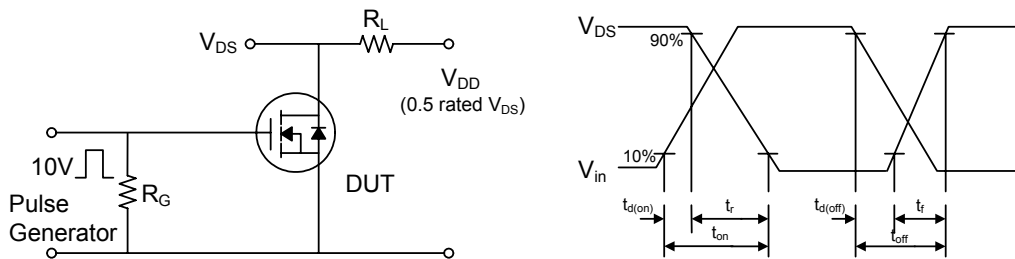
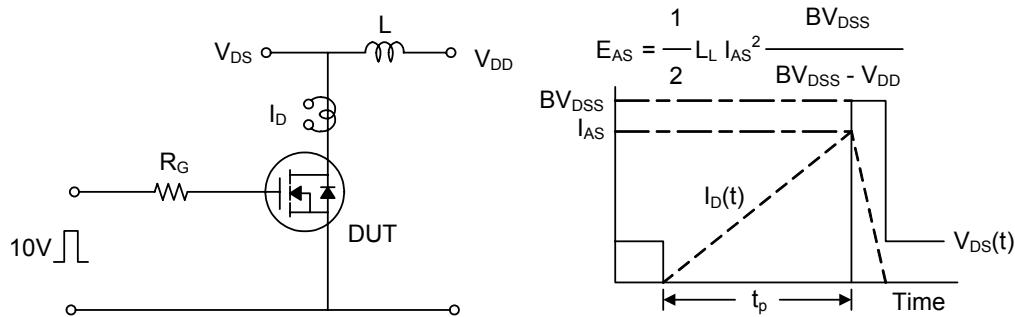
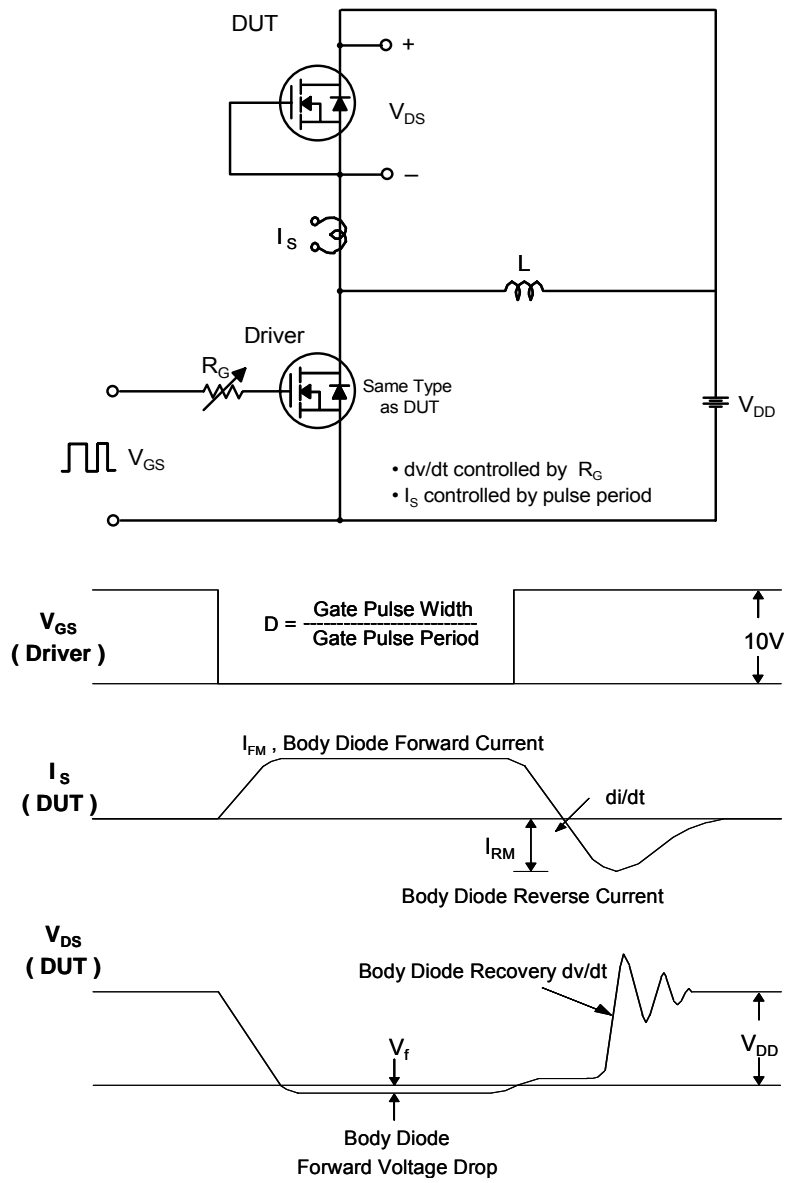

Fig 14. Unclamped Inductive Switching Test Circuit & Waveforms



DFD2N60

Fig. 15. Peak Diode Recovery dv/dt Test Circuit & Waveforms



DFD2N60

TO-252(D-PAK) Package Dimension

Dim.	mm			Inch		
	Min.	Typ.	Max.	Min.	Typ.	Max.
A	6.48	6.604	6.73	0.255	0.26	0.265
B	5.0	5.08	5.21	0.197	0.2	0.205
C	7.42	7.8	8.18	0.292	0.307	0.322
D	2.184	2.286	2.388	0.086	0.09	0.094
E	0.762	0.813	0.864	0.03	0.032	0.034
F	1.016	1.067	1.118	0.04	0.042	0.044
G		2.286			0.09	
H		2.286			0.09	
I	0.534	0.61	0.686	0.021	0.024	0.027
J	1.016	1.067	1.118	0.04	0.042	0.044
K		0.508			0.02	
L		0.762			0.03	
		1.57			0.06	

