



BYT60P-1000 BYT261PIV-1000

FAST RECOVERY RECTIFIER DIODES

MAJOR PRODUCT CHARACTERISTICS

$I_{F(AV)}$	2 x 60 A
V_{RRM}	1000 V
$V_F(\max)$	1.8 V
$t_{rr}(\max)$	70 ns

FEATURES AND BENEFITS

- VERY LOW REVERSE RECOVERY TIME
- VERY LOW SWITCHING LOSSES
- LOW NOISE TURN-OFF SWITCHING
- INSULATED PACKAGE: ISOTOP
 - Insulation voltage: 2500 V_{RMS}
 - Capacitance = 45 pF
 - Inductance < 5 nH

DESCRIPTION

Dual or high single voltage rectifier devices suited for Switch Mode Power Supplies and other power converters.

These devices are packaged in ISOTOP or in SOD93.

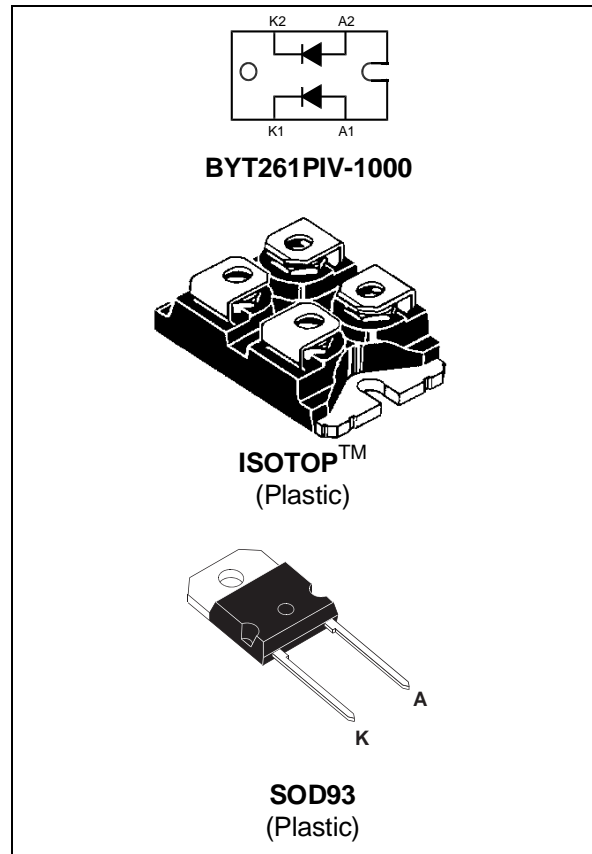

ABSOLUTE RATINGS (limiting values, per diode)

Symbol	Parameter		Value	Unit
V_{RRM}	Repetitive peak reverse voltage		1000	V
I_{FRM}	Repetitive peak forward current	$t_p=5\ \mu s$ $F=1kHz$	1000	A
$I_{F(RMS)}$	RMS forward current	ISOTOP	140	A
		SOD93	100	
$I_{F(AV)}$	Average forward current $\delta = 0.5$	$T_c = 50^\circ C$ ISOTOP	60	A
		$T_c = 60^\circ C$ SOD93	60	
I_{FSM}	Surge non repetitive forward current	$t_p = 10\ ms$ Sinusoidal	400	A
T_{stg}	Storage temperature range		- 40 to + 150	$^\circ C$
T_j	Maximum operating junction temperature		150	$^\circ C$

TM: ISOTOP is a registered trademark of STMicroelectronics.

BYT60P-1000 / BYT261PIV-1000

THERMAL RESISTANCES

Symbol	Parameter		Value	Unit	
$R_{th(j-c)}$	Junction to case	ISOTOP	Per diode Total	0.8 0.45	°C/W
		SOD93	Total	0.7	
$R_{th(c)}$			Coupling	0.1	°C/W

When the diodes 1 and 2 are used simultaneously :

$$\Delta T_j(\text{diode 1}) = P(\text{diode 1}) \times R_{th(j-c)} (\text{Per diode}) + P(\text{diode 2}) \times R_{th(c)}$$

STATIC ELECTRICAL CHARACTERISTICS (per diode)

Symbol	Parameter	Test Conditions		Min.	Typ.	Max.	Unit
V_F *	Forward voltage drop	$T_j = 25^\circ\text{C}$	$I_F = 60\text{ A}$			1.9	V
		$T_j = 100^\circ\text{C}$				1.8	
I_R **	Reverse leakage current	$T_j = 25^\circ\text{C}$	$V_R = V_{RRM}$			100	μA
		$T_j = 100^\circ\text{C}$				6	mA

Pulse test : * $t_p = 380\ \mu\text{s}$, $\delta < 2\%$

** $t_p = 5\ \text{ms}$, $\delta < 2\%$

To evaluate the conduction losses use the following equation:

$$P = 1.47 \times I_{F(AV)} + 0.005 I_{F(RMS)}^2$$

RECOVERY CHARACTERISTICS (per diode)

Symbol	Test Conditions		Min.	Typ.	Max.	Unit
t_{rr}	$T_j = 25^\circ\text{C}$	$I_F = 1\text{ A}$ $V_R = 30\text{ V}$ $dI_F/dt = -15\text{ A}/\mu\text{s}$			170	ns
		$I_F = 0.5\text{ A}$ $I_R = 1\text{ A}$ $I_{rr} = 0.25\text{ A}$			70	

TURN-OFF SWITCHING CHARACTERISTICS

Symbol	Parameter	Test Conditions		Min.	Typ.	Max.	Unit
t_{IRM}	Maximum reverse recovery time	$dI_F/dt = -240\ \text{A}/\mu\text{s}$	$V_{CC} = 200\ \text{V}$ $I_F = 60\ \text{A}$ $L_p \leq 0.05\ \mu\text{H}$ $T_j = 100^\circ\text{C}$ (see fig. 13)			200	ns
		$dI_F/dt = -480\ \text{A}/\mu\text{s}$				120	
I_{RM}	Maximum reverse recovery current	$dI_F/dt = -240\ \text{A}/\mu\text{s}$	$V_{CC} = 200\ \text{V}$ $I_F = I_{F(AV)}$ $L_p = 2.5\ \mu\text{H}$ (see fig. 14)			40	A
		$dI_F/dt = -480\ \text{A}/\mu\text{s}$				44	
$C = \frac{V_{RP}}{V_{CC}}$	Turn-off overvoltage coefficient	$T_j = 100^\circ\text{C}$ $V_{CC} = 200\text{ V}$ $I_F = I_{F(AV)}$ $dI_F/dt = -60\text{ A}/\mu\text{s}$ $L_p = 2.5\ \mu\text{H}$ (see fig. 14)			3.3	4.5	/

Fig. 1-1: Average forward power dissipation versus average forward current (per diode, ISOTOP).

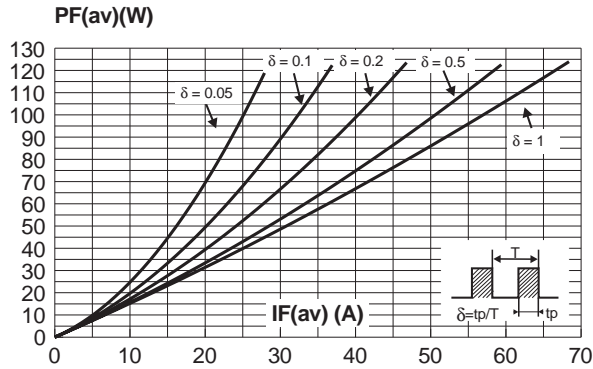

Fig. 1-2: Average forward power dissipation versus average forward current (SOD93).

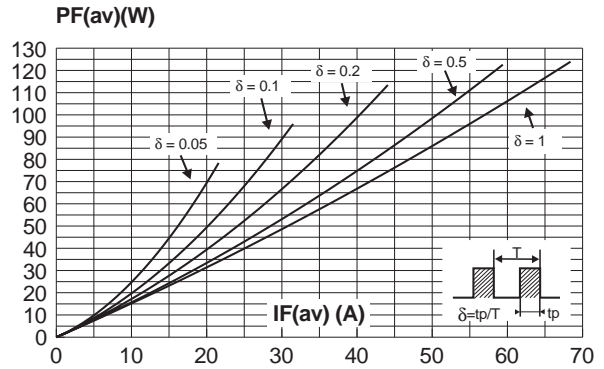

Fig. 2-1: Peak current versus form factor (per diode, ISOTOP).

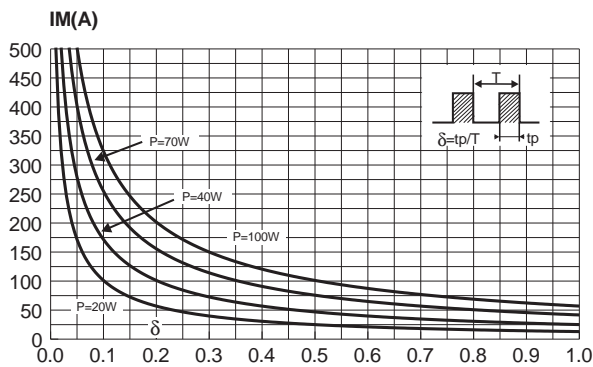

Fig. 2-2: Peak current versus form factor (SOD93).

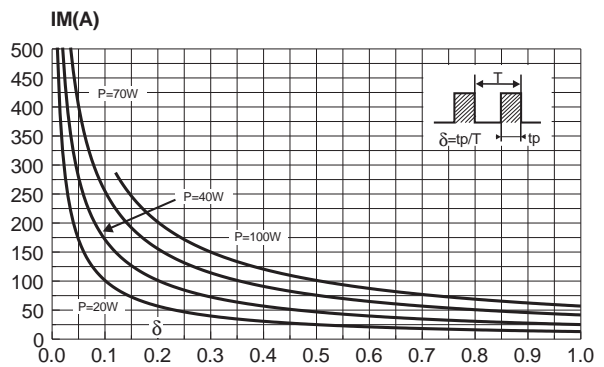

Fig. 3: Average forward current versus ambient temperature ($\delta=0.5$, per diode for ISOTOP).

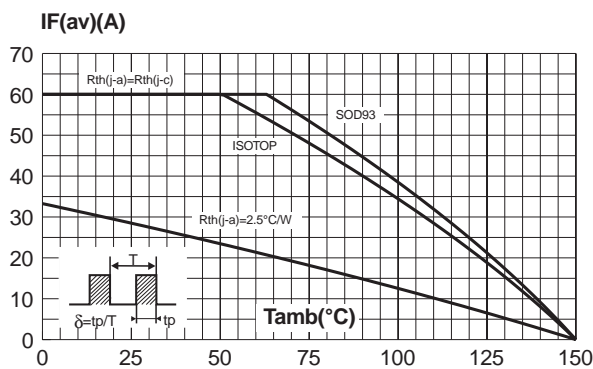

Fig. 4-1: Non repetitive surge peak forward current versus overload duration (SOD93).

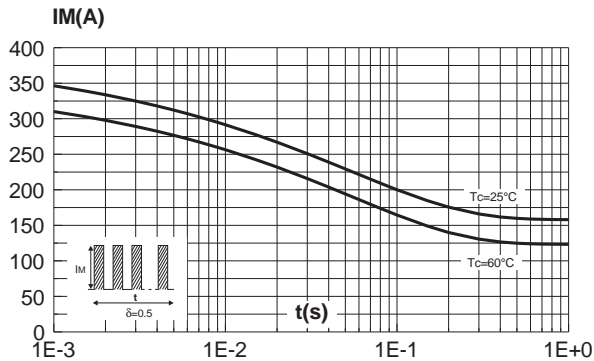

Fig. 4-2: Non repetitive surge peak forward current versus overload duration (per diode, ISOTOP).

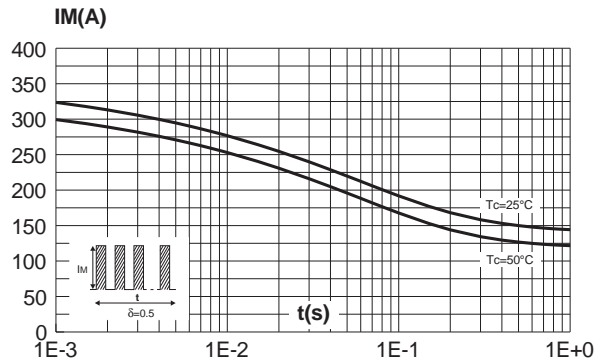

Fig. 5-1: Relative variation of thermal impedance junction to case versus pulse duration (per diode, ISOTOP).

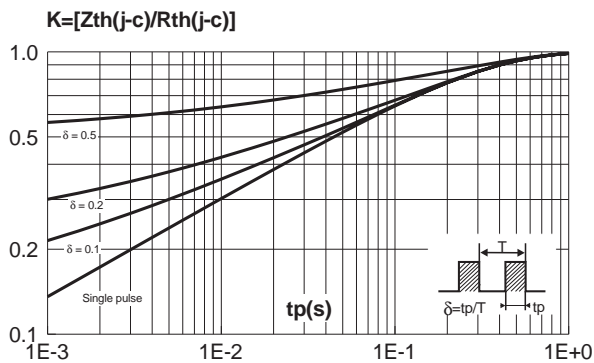

Fig. 5-2: Relative variation of thermal impedance junction to case versus pulse duration (SOD93).

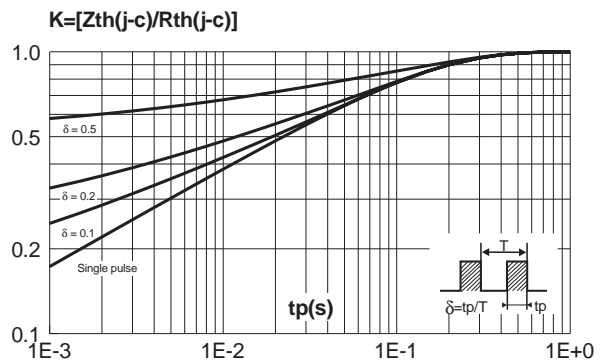

Fig. 6: Forward voltage drop versus forward current (maximum values, per diode for ISOTOP).

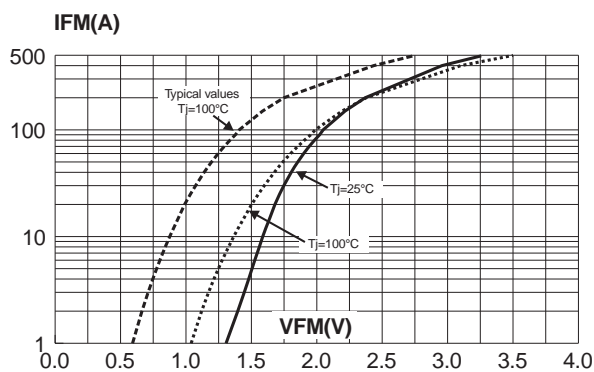

Fig. 7: Junction capacitance versus reverse voltage applied (typical values, per diode for ISOTOP).

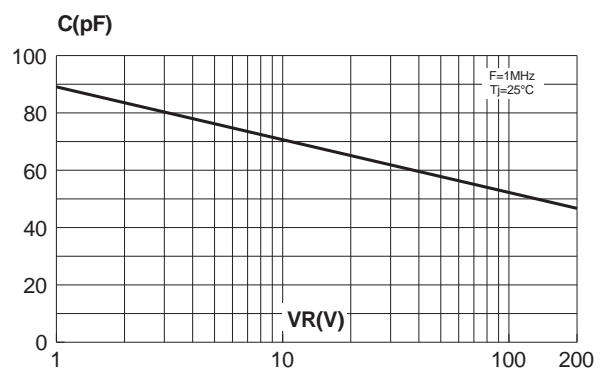

Fig. 8: Recovery charges versus dl_F/dt (per diode for ISOTOP).

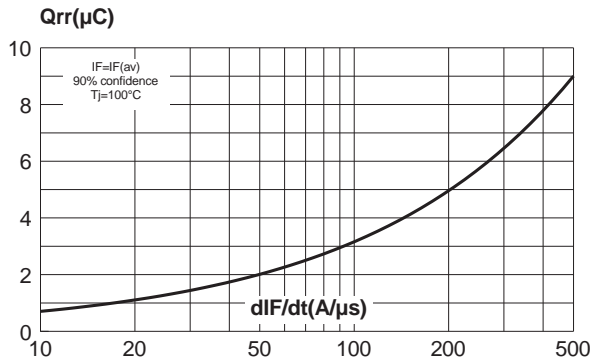

Fig. 9: Recovery current versus dl_F/dt (per diode for ISOTOP).

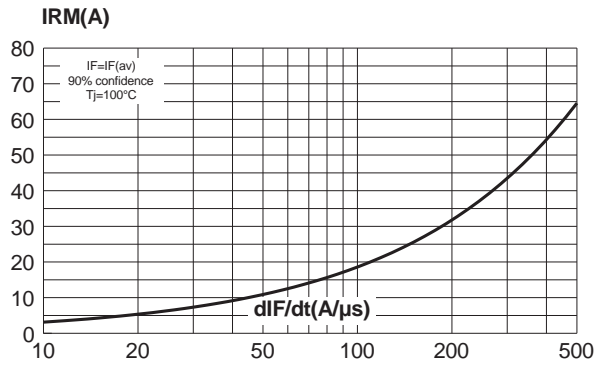

Fig. 10: Transient peak forward voltage versus dl_F/dt (per diode for ISOTOP).

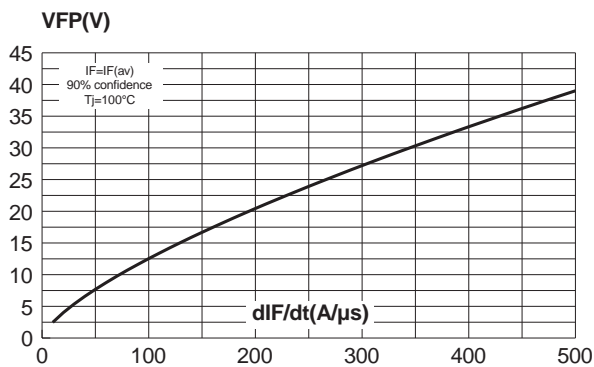

Fig. 11: Forward recovery time versus dl_F/dt (per diode for ISOTOP).

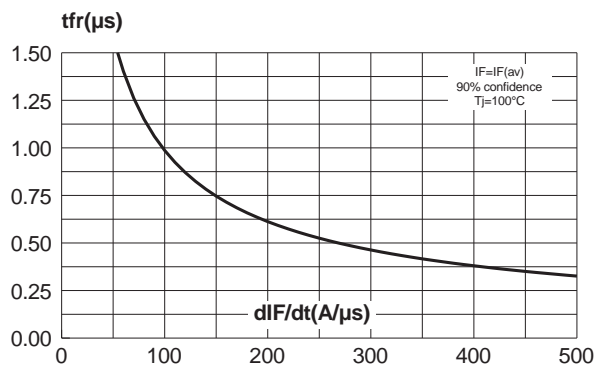
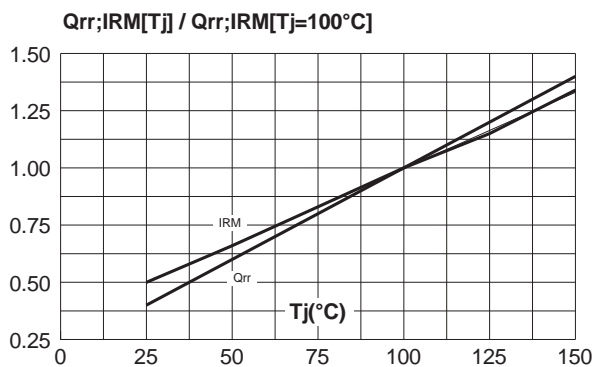

Fig. 12: Dynamic parameters versus junction temperature.



BYT60P-1000 / BYT261PIV-1000

Fig. 13: Turn-off switching characteristics (without serie inductance).

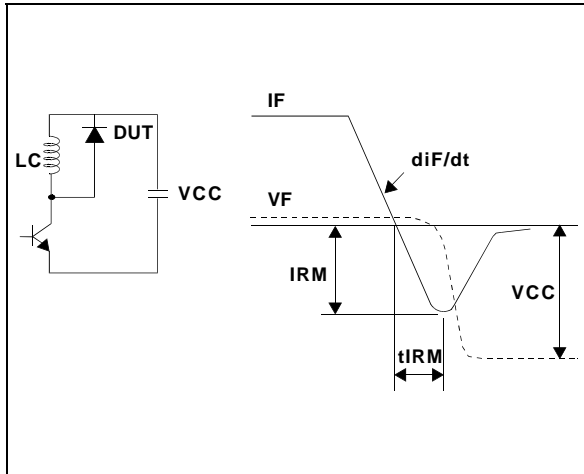
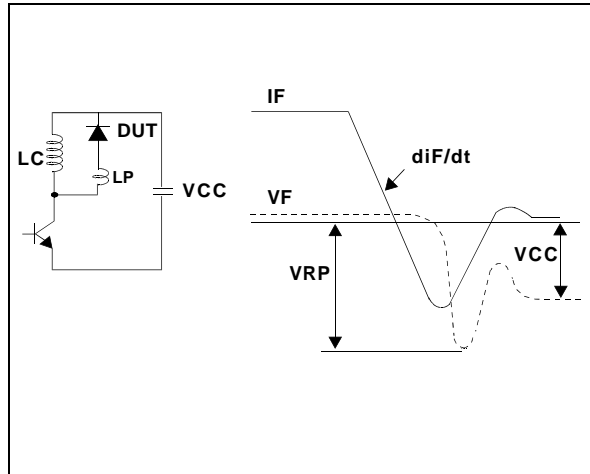
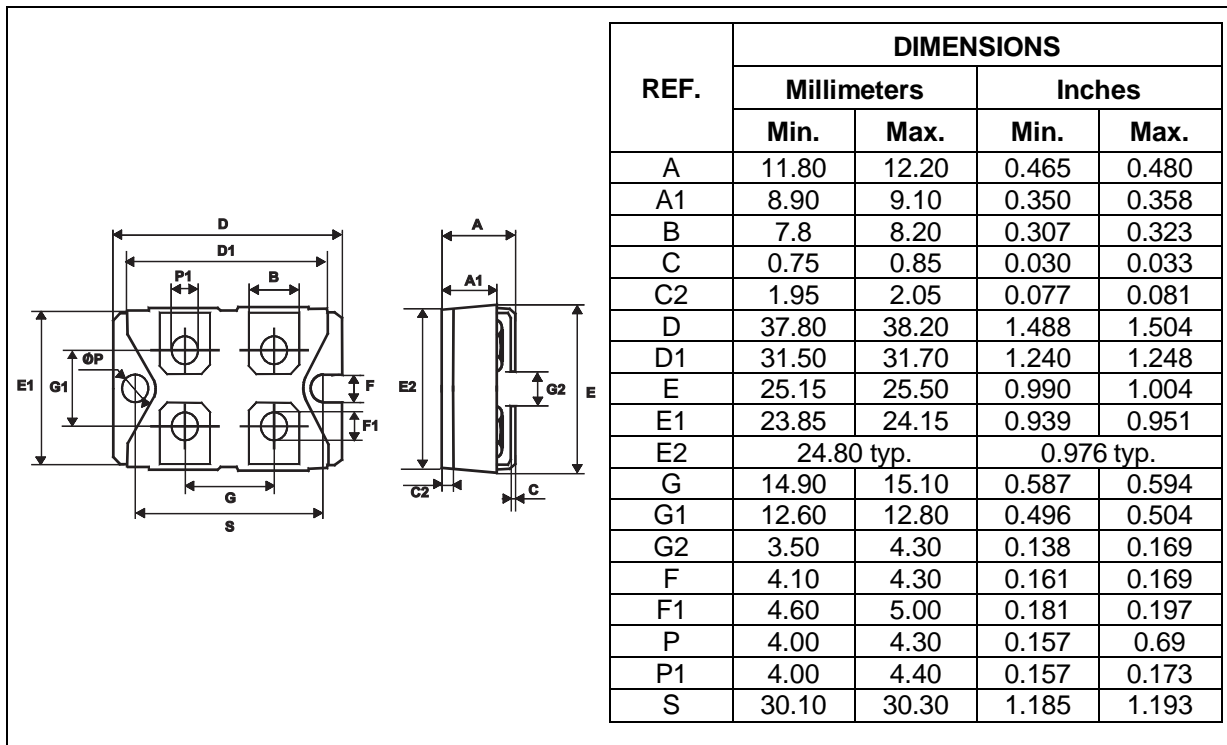

Fig. 14: Turn-off switching characteristics (with serie inductance).



PACKAGE MECHANICAL DATA

ISOTOP



PACKAGE MECHANICAL DATA

SOD93 Plastic

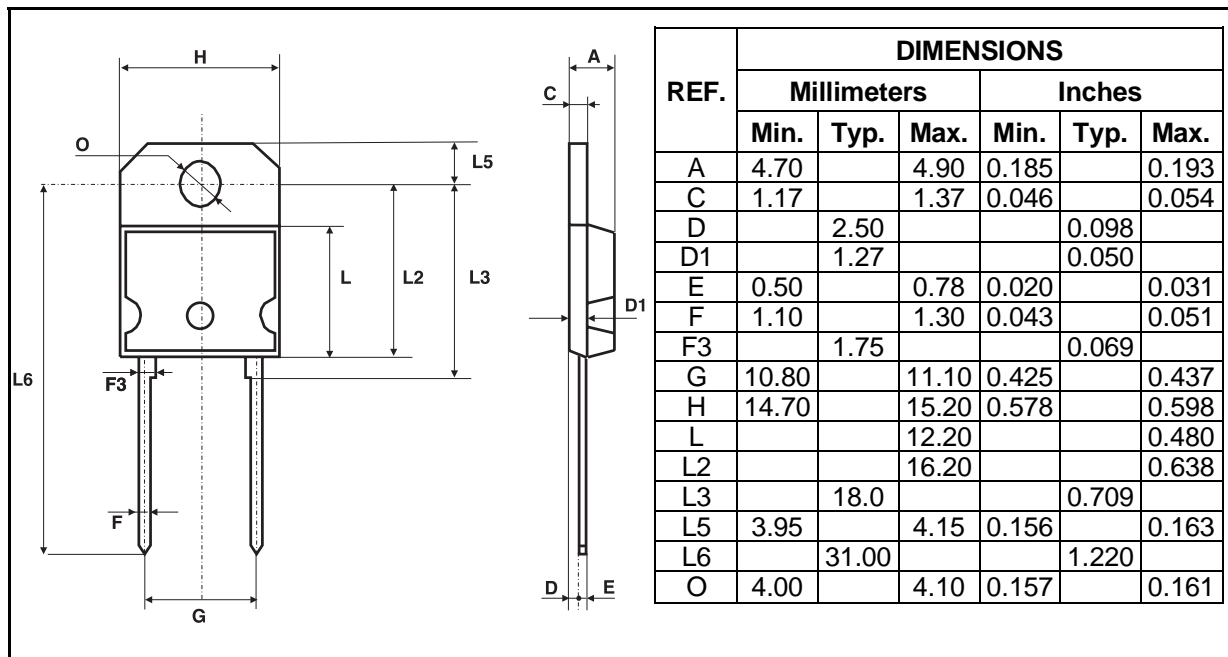

Ordering type	Marking	Package	Weight	Base qty	Delivery mode
BYT60P-1000	BYT60P-1000	SOD93	3.79 g.	30	Tube
BYT261PIV-1000	BYT261PIV-1000	ISOTOP	28 g. (without screws)	10	Tube

- Cooling method: by conduction (C)
- Recommended torque value (ISOTOP): 1.3 N.m (MAX 1.5 N.m) for the 6 x M4 screws. (2 x M4 screws recommended for mounting the package on the heatsink and the 4 screws given with the screw version). The screws supplied with the package are adapted for mounting on a board (or other types of terminals) with a thickness of 0.6 mm min and 2.2 mm max.
- Recommended torque value (SOD93): 0.8 N.m.
- Maximum torque value (SOD93): 1.0 N.m.
- Epoxy meets UL94,V0

Information furnished is believed to be accurate and reliable. However, STMicroelectronics assumes no responsibility for the consequences of use of such information nor for any infringement of patents or other rights of third parties which may result from its use. No license is granted by implication or otherwise under any patent or patent rights of STMicroelectronics. Specifications mentioned in this publication are subject to change without notice. This publication supersedes and replaces all information previously supplied. STMicroelectronics products are not authorized for use as critical components in life support devices or systems without express written approval of STMicroelectronics.

The ST logo is a registered trademark of STMicroelectronics

© 1999 STMicroelectronics - Printed in Italy - All rights reserved.

STMicroelectronics GROUP OF COMPANIES

Australia - Brazil - China - Finland - France - Germany - Hong Kong - India - Italy - Japan - Malaysia
 Malta - Morocco - Singapore - Spain - Sweden - Switzerland - United Kingdom - U.S.A.

<http://www.st.com>

