

**NEC**

# 3V, 2400 MHz MEDIUM POWER SI MMIC AMPLIFIER

**UPC2771T**

## FEATURES

- **HIGH GAIN:** 20 dB at 900 to 1500 MHz Typical
- **HIGH OUTPUT POWER:**  $P_{SAT} = +12.5$  dBm at 900 MHz  
+11 dBm at 1500 MHz
- **LOW BIAS VOLTAGE:** 3.0 V Typical, 2.7 V Minimum
- **SUPER SMALL PACKAGE**
- **TAPE AND REEL PACKAGING OPTION AVAILABLE**

## DESCRIPTION

The UPC2771T is a Silicon Monolithic integrated circuit which is manufactured using the NESAT III process. The NESAT III process produces transistors with  $f_T$  approaching 20 GHz. This amplifier was designed as a driver amplifier for digital cellular applications. Operating on a 3 volt supply, this IC is ideally suited for hand-held, portable designs.

NEC's stringent quality assurance and test procedures ensure the highest reliability and performance.

GAIN vs. FREQUENCY AND TEMPERATURE

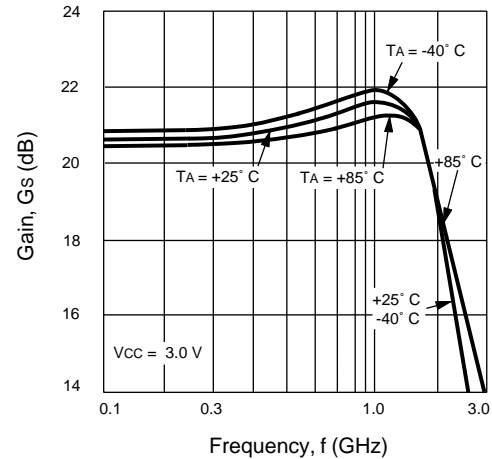

## ELECTRICAL CHARACTERISTICS (TA = 25°C, ZL = Zs = 50 Ω, VCC = 3.0 V)

PART NUMBER PACKAGE OUTLINE			UPC2771T T06		
SYMBOLS	PARAMETERS AND CONDITIONS	UNITS	MIN	TYP	MAX
I <sub>CC</sub>	Circuit Current (no signal)	mA		36	45
G <sub>s</sub>	Small Signal Gain, f = 900 MHz f = 1500 MHz	dB dB	19 17	21 20	24 23
f <sub>u</sub>	Upper Limit Operating Frequency (The gain at f <sub>u</sub> is 3 dB down from the gain at 100 MHz)	GHz	1.7	2.1	
P <sub>1dB</sub>	1 dB Compressed Output Power, f = 900 MHz f = 1500 MHz	dBm dBm	+9 +7	+11.5 +9.5	
P <sub>SAT</sub>	Saturated Output Power, f = 900 MHz f = 1500 MHz	dBm dBm		+12.5 +11	
NF	Noise Figure, f = 900 MHz f = 1500 MHz	dB dB		6 6	7.5 7.5
RL <sub>IN</sub>	Input Return Loss, f = 900 MHz f = 1500 MHz	dB dB	10 10	14 14	
RL <sub>OUT</sub>	Output Return Loss, f = 900 MHz f = 1500 MHz	dB dB	6.5 5.5	9.5 8.5	
ISOL	Isolation, f = 900 MHz f = 1500 MHz	dB dB	25 25	30 30	
OIP3	SSB Output Third Order Intercept Point f = 900, 902 MHz f = 1500, 1502 MHz	dBm dBm		+16 +13	

**ABSOLUTE MAXIMUM RATINGS<sup>1</sup>** (T<sub>A</sub> = 25°C)

SYMBOLS	PARAMETERS	UNITS	RATINGS
V <sub>CC</sub>	Supply Voltage	V	3.6
I <sub>CC</sub>	Total Supply Current	mA	77.7
P <sub>IN</sub>	Input Power	dBm	+13
P <sub>T</sub>	Total Power Dissipation <sup>2</sup>	mW	280
T <sub>OP</sub>	Operating Temperature	°C	-40 to +85
T <sub>STG</sub>	Storage Temperature	°C	-55 to +150

Notes:

1. Operation in excess of any one of these parameters may result in permanent damage.
2. Mounted on a 50 X 50 X 1.6 mm epoxy glass PWB (T<sub>A</sub> = 85°C).

**RECOMMENDED OPERATING CONDITIONS**

SYMBOLS	PARAMETERS	UNITS	MIN	TYP	MAX
V <sub>CC</sub>	Supply Voltage	V	2.7	3	3.3
T <sub>OP</sub>	Operating Temperature	°C	-40	+25	+85

**TYPICAL PERFORMANCE CURVES** (T<sub>A</sub> = 25°C)

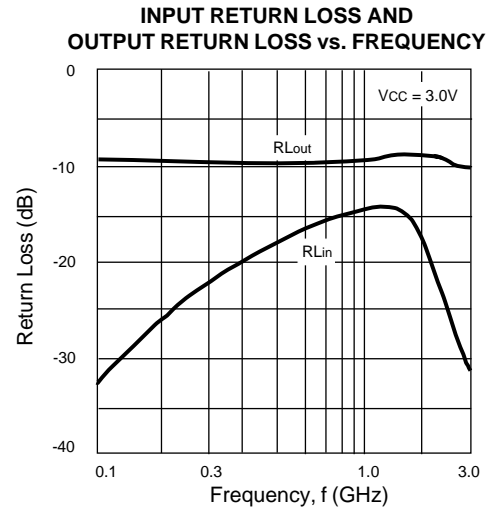
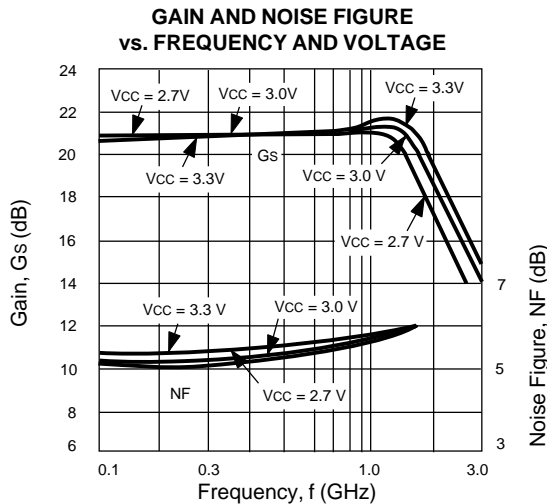
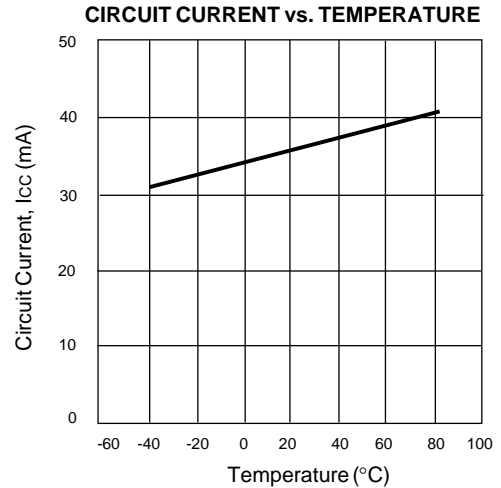
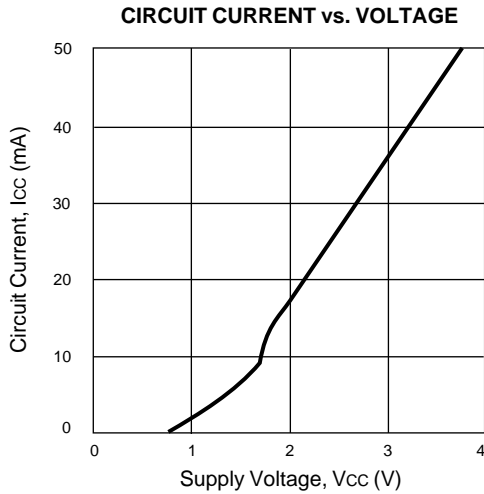

**TEST CIRCUIT**

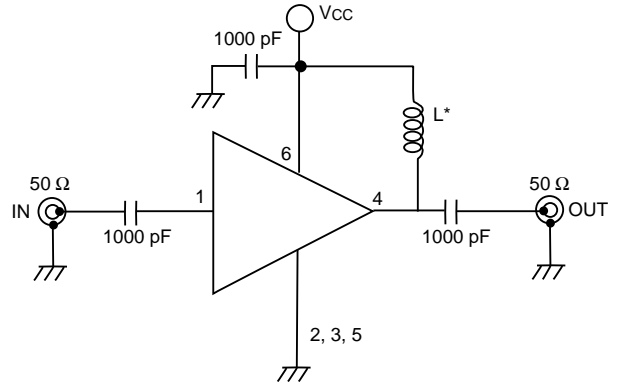

\* This device is tested using a bias tee with typical series inductance, L = 1000 nH. In circuit applications, L = 50 nH is satisfactory at 900 MHz, and L = 10 nH is satisfactory at 1500 MHz.

**TYPICAL PERFORMANCE CURVES** ( $T_A = 25^\circ$ )

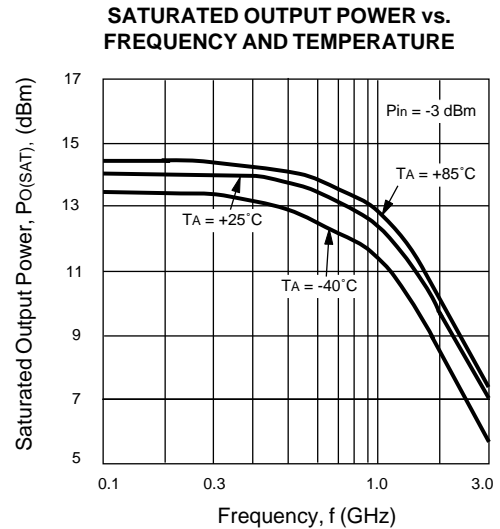
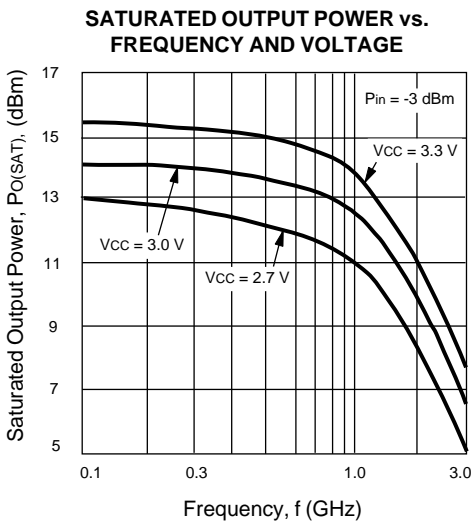
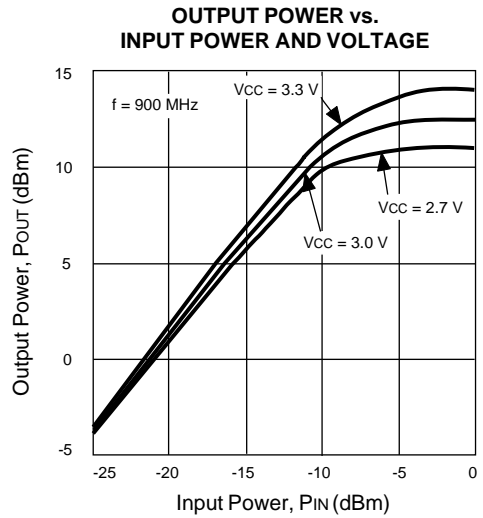
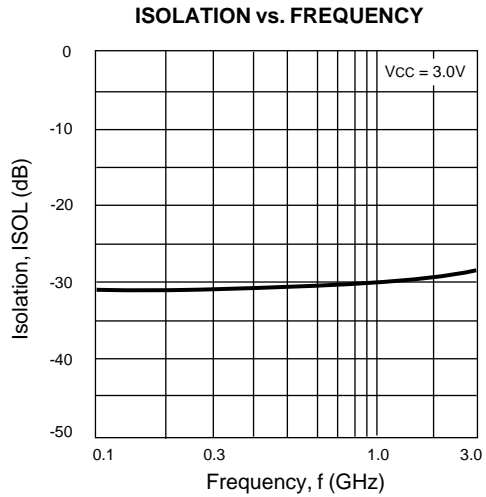

**S11 vs. FREQUENCY**  
( $V_{CC} = 3.0\text{ V}$ )

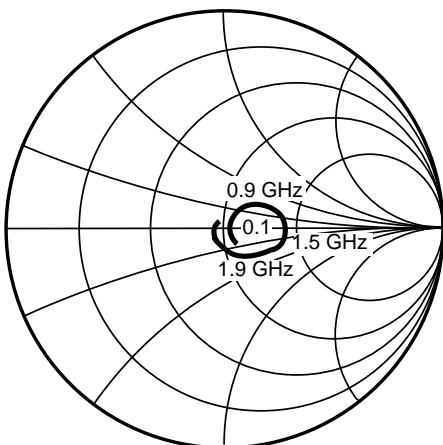

**S22 vs. FREQUENCY**  
( $V_{CC} = 3.0\text{ V}$ )

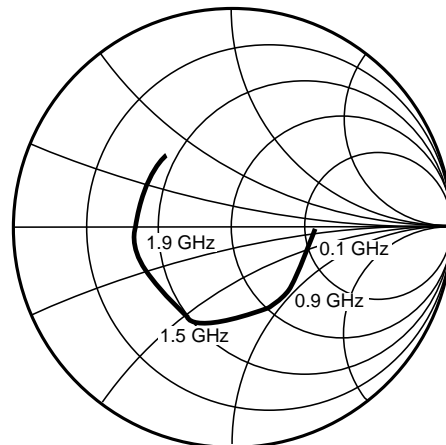

# UPC2771T

## OUTLINE DIMENSIONS (Units in mm)

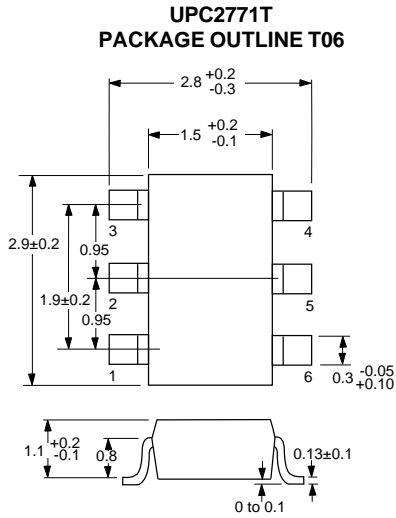

## LEAD CONNECTIONS

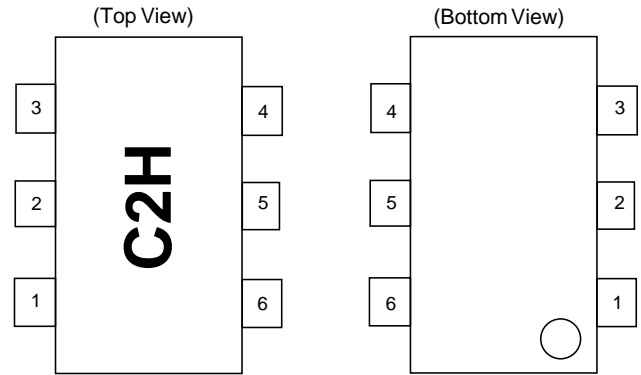

1. INPUT
2. GND
3. GND
4. OUTPUT
5. GND
6. Vcc

## RECOMMENDED P.C.B. LAYOUT (Units in mm)

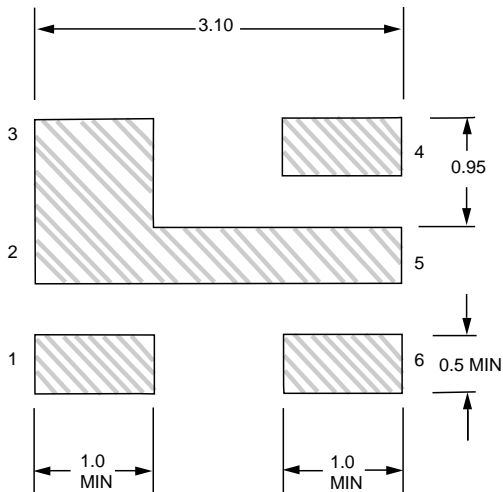

Note:  
All dimensions are typical unless otherwise specified.

## EQUIVALENT CIRCUIT

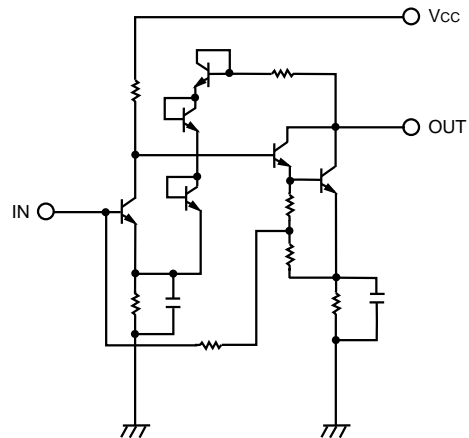

## ORDERING INFORMATION

PART NUMBER	QTY
UPC2771T-E3	3K/Reel

Note:  
Embossed Tape, 8 mm wide.

EXCLUSIVE AGENT FOR **NEC Corporation** RF & MICROWAVE SEMICONDUCTOR PRODUCTS - U.S. & CANADA

CALIFORNIA EASTERN LABORATORIES, INC • Headquarters • 4590 Patrick Henry Drive • Santa Clara, CA 95054-1817 • (408) 988-3500 • Telex 34-6393/FAX (408) 988-0279

DATA SUBJECT TO CHANGE WITHOUT NOTICE



PRINTED IN USA ON RECYCLED PAPER 11/95