

**THYRISTOR/ DIODE and  
 THYRISTOR/ THYRISTOR**

**NEWADD-A-pak™ Power Modules**

**Features**

- Electrically isolated: DBC base plate
- 3500 V<sub>RMS</sub> isolating voltage
- Standard JEDEC package
- Simplified mechanical designs, rapid assembly
- Auxiliary cathode terminals for wiring convenience
- High surge capability
- Wide choice of circuit configurations
- Large creepage distances
- UL E78996 approved 

45 A  
 60 A

**Description**

These IRK series of NEW ADD-A-paks use power diodes and thyristors in a variety of circuit configurations. The semiconductor chips are electrically isolated from the base plate, allowing common heatsinks and compact assemblies to be built. They can be interconnected to form single phase or three phase bridges or AC controllers. These modules are intended for general purpose high voltage applications such as high voltage regulated power supplies, lighting circuits, and temperature and motor speed control circuits.

**Major Ratings and Characteristics**

Parameters	IRK.41	IRK.56	Units
$I_{T(AV)}$ or $I_{F(AV)}$ @ 85°C	45	60	A
$I_{O(RMS)}$ (*)	100	135	A
$I_{TSM}$ @ 50Hz	850	1310	A
$I_{FSM}$ @ 60Hz	890	1370	A
$I^2t$ @ 50Hz	3.61	8.50	KA <sup>2</sup> s
@ 60Hz	3.30	7.82	KA <sup>2</sup> s
$I^2t$	36.1	85.0	KA <sup>2</sup> /s
$V_{RRM}$ range	400 to 1600		V
$T_{STG}$	-40 to 125		°C
$T_J$	-40 to 125		°C

(\*) As AC switch.

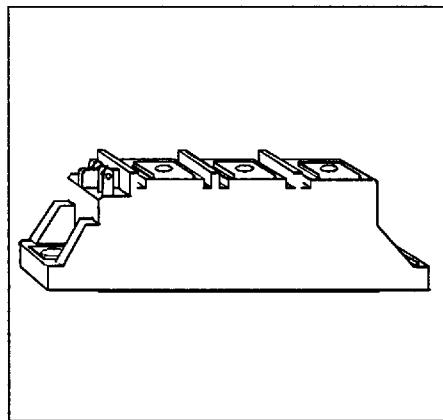

**IRK.41, .56 Series**

Bulletin I27131 rev. C 09/97

International  
**IRF** Rectifier

**ELECTRICAL SPECIFICATIONS**

**Voltage Ratings**

Type number	Voltage Code	$V_{RRM}$ , maximum repetitive peak reverse voltage V	$V_{RSM}$ , maximum non-repetitive peak reverse voltage V	$V_{DRM}$ , max. repetitive peak off-state voltage, gate open circuit V	$I_{FRM}$ , 125°C mA
IRK.41/.56	04	400	500	400	15
	06	600	700	600	
	08	800	900	800	
	10	1000	1100	1000	
	12	1200	1300	1200	
	14	1400	1500	1400	
	16	1600	1700	1600	

**On-state Conduction**

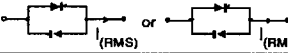
Parameters	IRK.41	IRK.56	Units	Conditions		
$I_{T(AV)}$ Max. average on-state current (Thyristors)	45	60	A	180° conduction, half sine wave, $T_c = 85^\circ\text{C}$		
$I_{F(AV)}$ Maximum average forward current (Diodes)	45	60				
$I_{O(RMS)}$ Max. continuous RMS on-state current. As AC switch	100	135				
$I_{TSM}$ Max. peak, one cycle or non-repetitive on-state or forward current	850	1310			KA <sup>2</sup> s	 Sinusoidal half wave, Initial $T_J = T_J \text{ max.}$
	890	1370				
	715	1100				
	750	1150				
	940	1450				
$I^2t$ Max. $I^2t$ for fusing	3.61	8.56	KA <sup>2</sup> s	Initial $T_J = T_J \text{ max.}$		
	3.30	7.82				
	2.56	6.05				
	2.33	5.53				
	4.42	10.05				
$I^2\sqrt{t}$ Max. $I^2\sqrt{t}$ for fusing (1)	36.1	85.6	KA <sup>2</sup> √s	no voltage reappplied		
	4.03	9.60				
$V_{T(TO)}$ Max. value of threshold voltage (2)	0.88	0.85	V	Low level (3) High level (4)		
	0.91	0.88				
$r_t$ Max. value of on-state slope resistance (2)	5.90	3.53	mΩ	Low level (3) High level (4)		
	5.74	3.41				
$V_{TM}$ Max. peak on-state or forward voltage	1.81	1.54	V	$I_{TM} = \pi \times I_{T(AV)}$		
				$I_{FM} = \pi \times I_{F(AV)}$		
$dI/dt$ Max. non-repetitive rate of rise of turned on current	150		A/μs	$T_J = 25^\circ\text{C}$ , from 0.67 $V_{DRM}$ , $I_{TM} = \pi \times I_{T(AV)}$ , $I_g = 500\text{mA}$ , $t_r < 0.5 \mu\text{s}$ , $t_p > 6 \mu\text{s}$		
$I_H$ Max. holding current	200		mA	$T_J = 25^\circ\text{C}$ , anode supply = 6V, resistive load, gate open circuit		
$I_L$ Max. latching current	400					

(1)  $I^2t$  for time  $t_x = I^2t \times \sqrt{t_x}$  (2) Average power =  $V_{T(TO)} \times I_{T(AV)} + r_t \times (I_{T(RMS)})^2$  (3)  $16.7\% \times \pi \times I_{AV} < I < \pi \times I_{AV}$   
 (4)  $I > \pi \times I_{AV}$

Triggering

Parameters	IRK.41	IRK.56	Units	Conditions	
$P_{GM}$ Max. peak gate power	10	10	W		
$P_{G(AV)}$ Max. average gate power	2.5	2.5			
$I_{GM}$ Max. peak gate current	2.5	2.5	A		
$-V_{GM}$ Max. peak negative gate voltage	10		V	Anode supply = 6V resistive load	
$V_{GT}$ Max. gate voltage required to trigger	4.0				$T_J = -40^\circ\text{C}$
	2.5				$T_J = 25^\circ\text{C}$
	1.7				$T_J = 125^\circ\text{C}$
$I_{GT}$ Max. gate current required to trigger	270		mA	Anode supply = 6V resistive load	
	150				$T_J = 25^\circ\text{C}$
	80				$T_J = 125^\circ\text{C}$
$V_{GD}$ Max. gate voltage that will not trigger	0.25		V	$T_J = 125^\circ\text{C}$ , rated $V_{DRM}$ applied	
$I_{GD}$ Max. gate current that will not trigger	6		mA	$T_J = 125^\circ\text{C}$ , rated $V_{DRM}$ applied	

Blocking

Parameters	IRK.41	IRK.56	Units	Conditions
$I_{RRM}$ Max. peak reverse and off-state leakage current at $V_{RRM}$ , $V_{DRM}$	15		mA	$T_J = 125^\circ\text{C}$ , gate open circuit
$V_{INS}$ RMS isolation voltage	2500 (1 min) 3500 (1 sec)		V	50 Hz, circuit to base, all terminals shorted
dv/dt Max. critical rate of rise of off-state voltage (5)	500		V/ $\mu\text{s}$	$T_J = 125^\circ\text{C}$ , linear to 0.67 $V_{DRM}$ , gate open circuit

(5) Available with dv/dt = 1000V/ $\mu\text{s}$ , to complete code add S90 i.e. IRKT41/16 S90.

Thermal and Mechanical Specifications

Parameters	IRK.41	IRK.56	Units	Conditions
$T_J$ Junction operating temperature range	- 40 to 125		°C	
$T_{stg}$ Storage temp. range	- 40 to 125			
$R_{thJC}$ Max. internal thermal resistance, junction to case	0.23	0.20	K/W	Per module, DC operation
$R_{thCS}$ Typical thermal resistance case to heatsink	0.1			Mounting surface flat, smooth and greased. Flatness < 0.03 mm; roughness < 0.02 mm
T Mounting torque $\pm 10\%$ to heatsink busbar	5		Nm	A mounting compound is recommended and the torque should be rechecked after a period of 3 hours to allow for the spread of the compound
	3			
wt Approximate weight	83 (3)		g (oz)	
Case style	TO-240AA		JEDEC	

**IRK.41, .56 Series**

Bulletin I27131 rev. C 09/97

International  
**IRG** Rectifier

**ΔR Conduction (per Junction)**

(The following table shows the increment of thermal resistance  $R_{thJC}$  when devices operate at different conduction angles than DC)

Devices	Sine half wave conduction					Rect. wave conduction					Units
	180°	120°	90°	60°	30°	180°	120°	90°	60°	30°	
IRK.41	0.11	0.13	0.17	0.23	0.34	0.09	0.14	0.18	0.23	0.34	°C/W
IRK.56	0.09	0.11	0.13	0.18	0.27	0.07	0.11	0.14	0.19	0.28	

**Outlines Table**

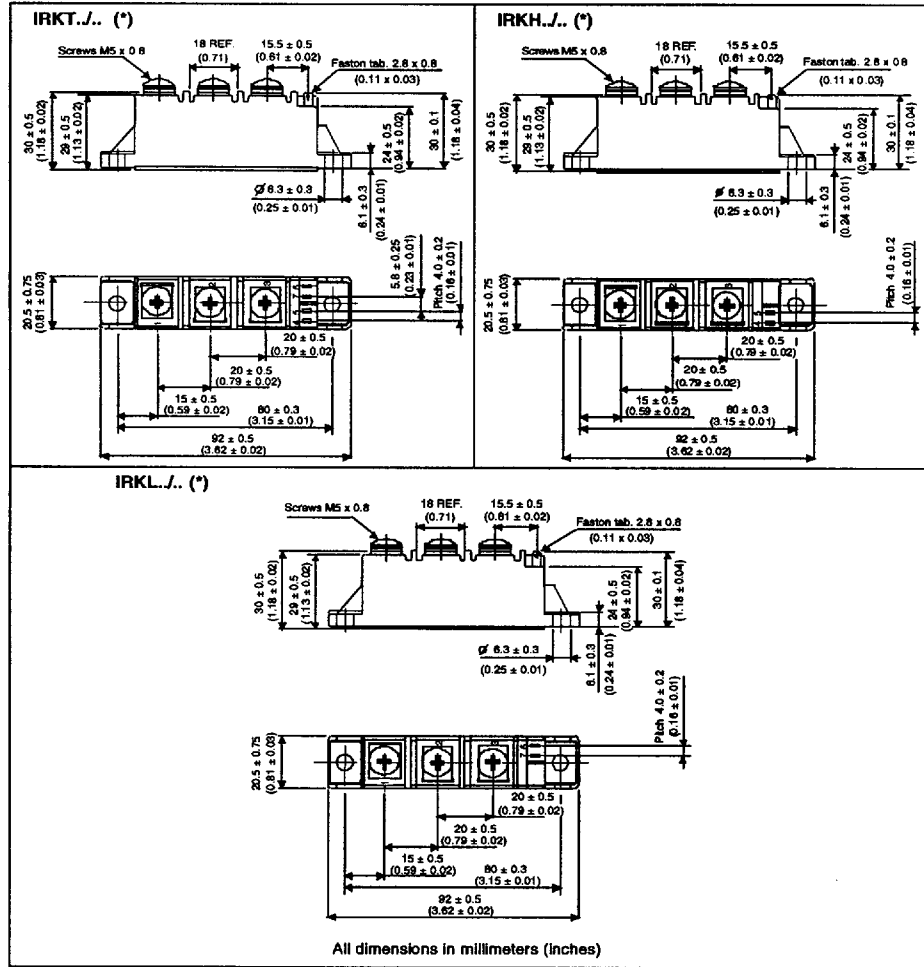

(\*) For terminals connections, see Circuit configurations Table

**NOTE: To order the Optional Hardware see Bulletin I27900**

**Circuit Configurations Table**

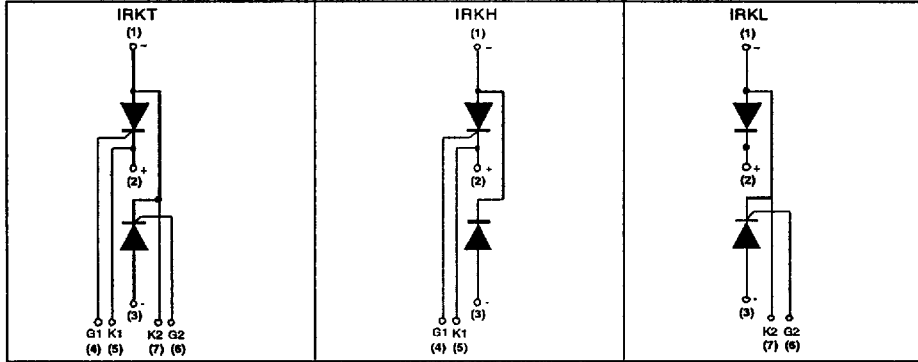

**Ordering Information Table**

**Device Code**

IRK	T	56	/	16	S90
①	②	③		④	⑤

- 1 - Module type
- 2 - Circuit configuration (See Circuit Configuration table)
- 3 - Current code \*\*
- 4 - Voltage code (See Voltage Ratings table)
- 5 - dv/dt code: S90 = dv/dt 1000 V/μs  
No letter = dv/dt 500 V/μs

IRK.57 types  
 With no auxiliary cathode

\*\* Available with no auxiliary cathode.  
 To specify change: 41 to 42  
 56 to 57  
 e.g. : IRKT57/16 etc.

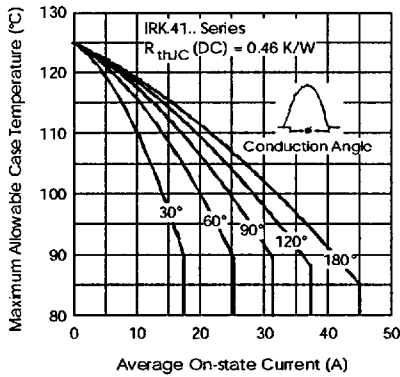

Fig. 1 - Current Ratings Characteristics

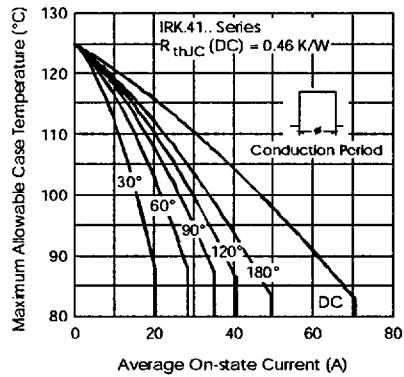

Fig. 2 - Current Ratings Characteristics

**IRK.41, .56 Series**

Bulletin I27131 rev. C 09/97

International  
**IR Rectifier**

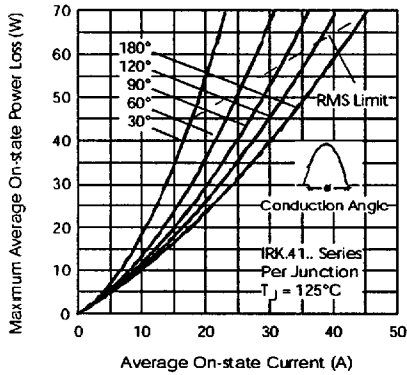

Fig. 3 - On-state Power Loss Characteristics

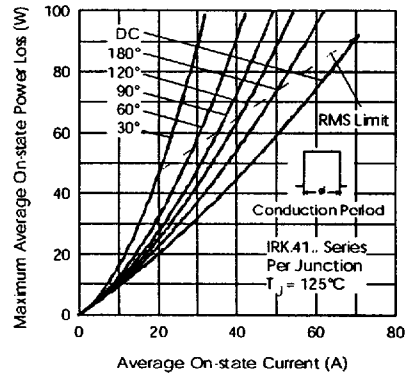

Fig. 4 - On-state Power Loss Characteristics

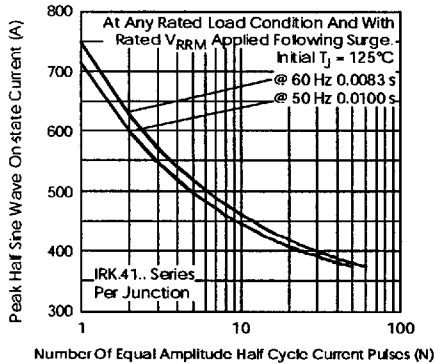

Fig. 5 - Maximum Non-Repulsive Surge Current

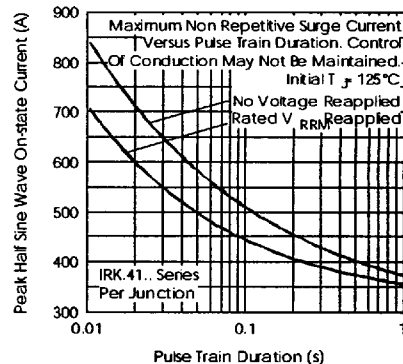

Fig. 6 - Maximum Non-Repulsive Surge Current

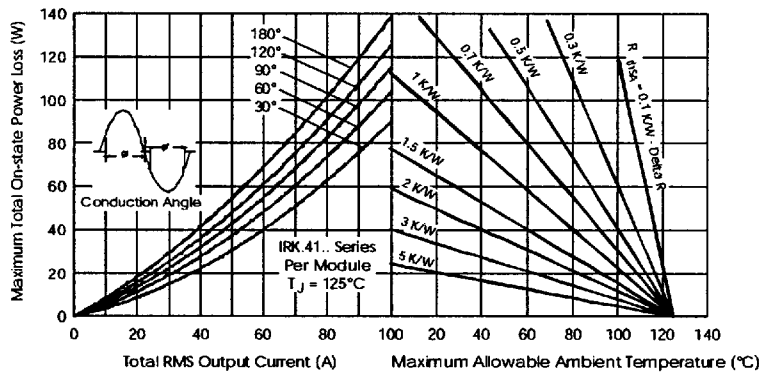

Fig. 7 - On-state Power Loss Characteristics

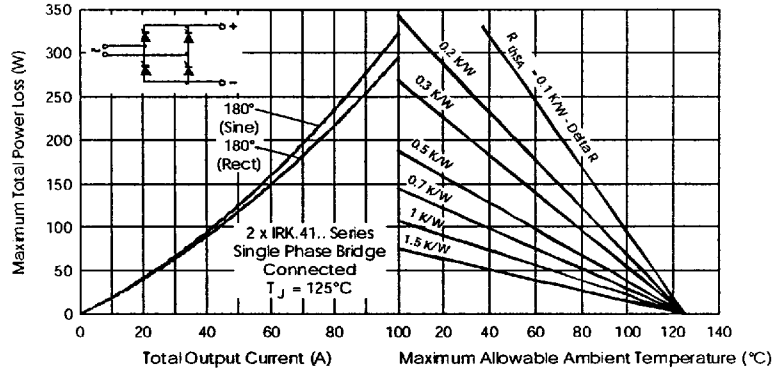

Fig. 8 - On-state Power Loss Characteristics

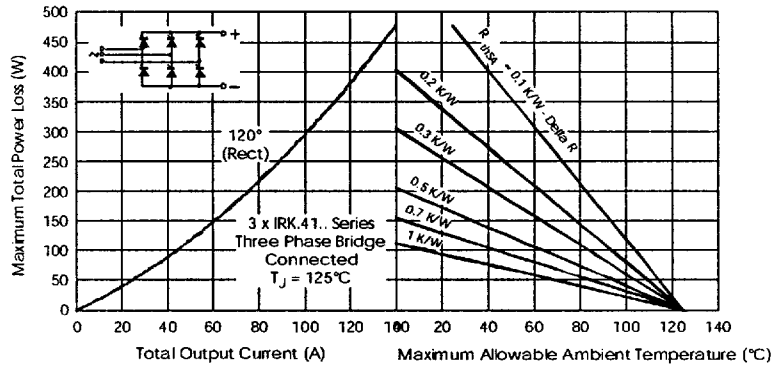

Fig. 9 - On-state Power Loss Characteristics

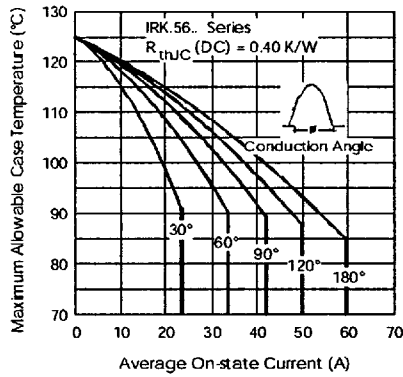

Fig. 10 - Current Ratings Characteristics

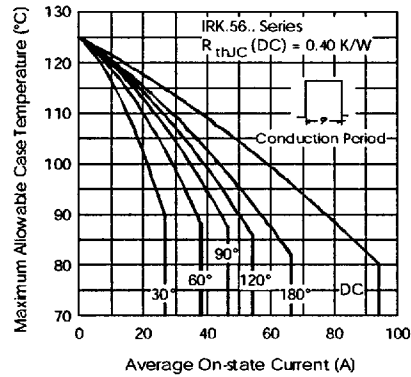

Fig. 11 - Current Ratings Characteristics

**IRK.41, .56 Series**

Bulletin I27131 rev. C 09/97

International  
**IR** Rectifier

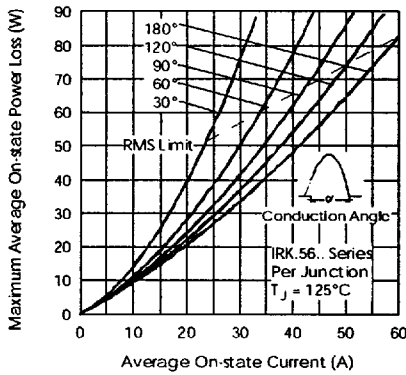

Fig. 12 - On-state Power Loss Characteristics

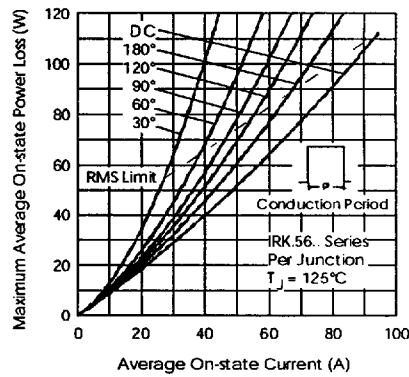

Fig. 13 - On-state Power Loss Characteristics

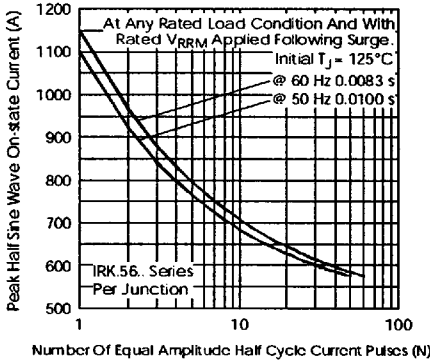

Fig. 14 - Maximum Non-Repetitive Surge Current

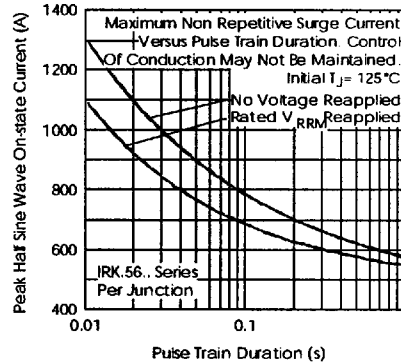

Fig. 15 - Maximum Non-Repetitive Surge Current

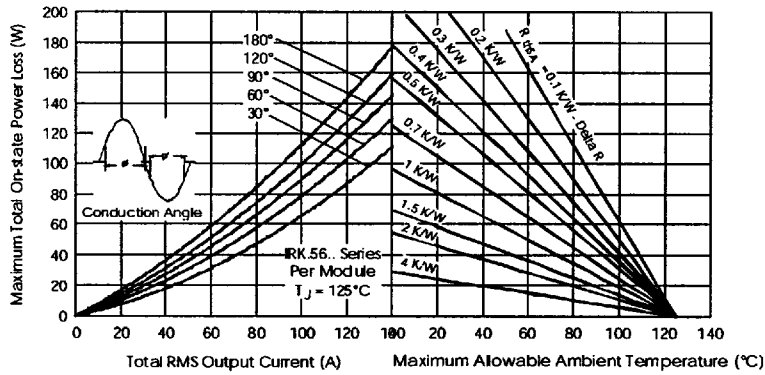

Fig. 16 - On-state Power Loss Characteristics



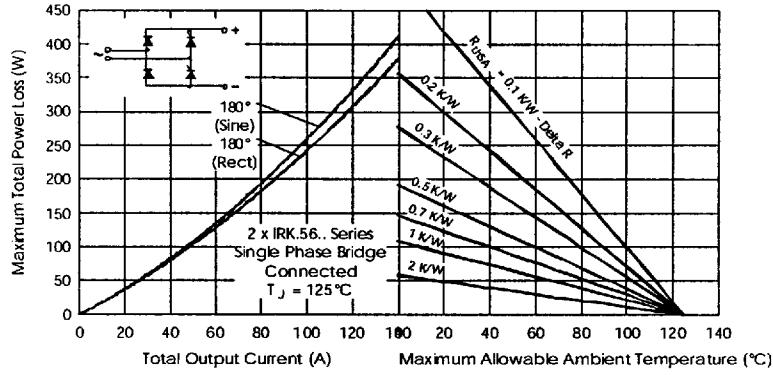

Fig. 17 - On-state Power Loss Characteristics

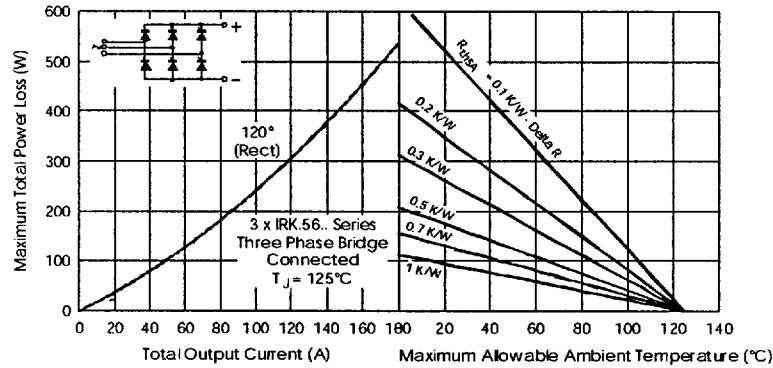

Fig. 18 - On-state Power Loss Characteristics

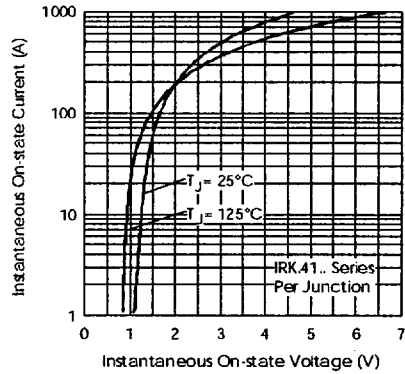

Fig. 19 - On-state Voltage Drop Characteristics

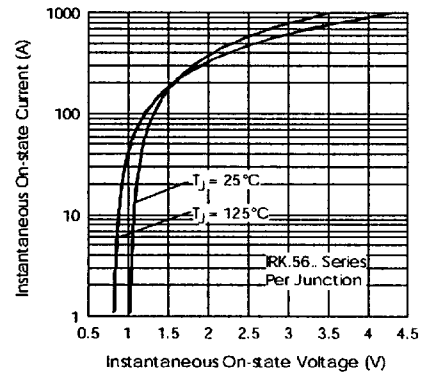

Fig. 20 - On-state Voltage Drop Characteristics

# IRK.41, .56 Series

Bulletin I27131 rev. C 09/97

International  
**IRF** Rectifier

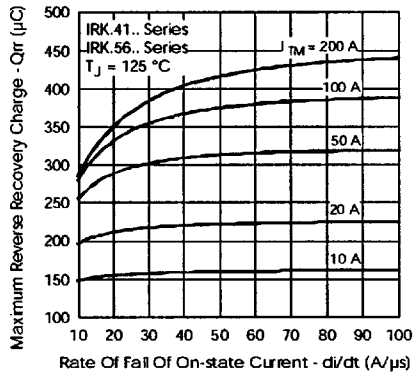

Fig. 21 - Recovery Charge Characteristics

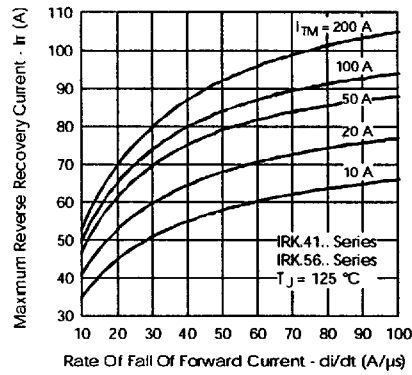

Fig. 22 - Recovery Current Characteristics

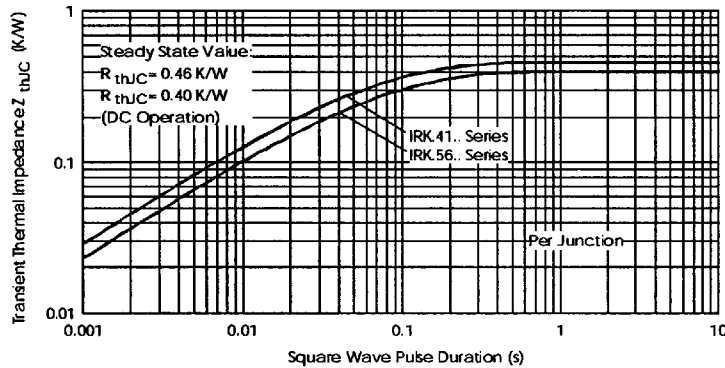

Fig. 23 - Thermal Impedance  $Z_{thJC}$  Characteristics

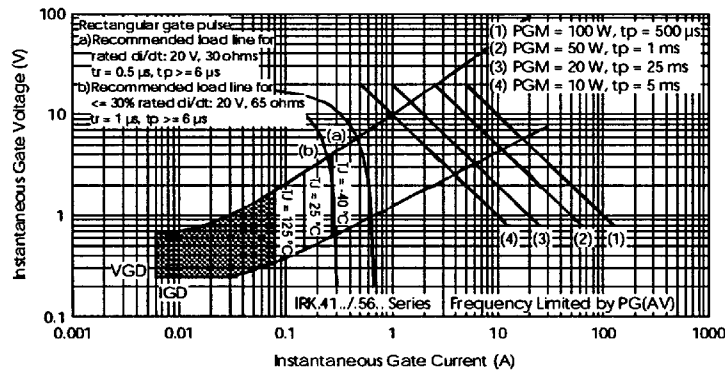

Fig. 24 - Gate Characteristics