

BCR20A, BCR20B, BCR20C, BCR20E

MEDIUM POWER USE

A, B, C : NON-INSULATED TYPE, E : INSULATED TYPE, GLASS PASSIVATION TYPE

BCR20A, BCR20B, BCR20C, BCR20E



- I_T (RMS) 20A
- V_{DRM} 400V/500V
- $I_{FGT I}$, $I_{RGT I}$, $I_{RGT III}$ 30mA

OUTLINE DRAWING

Dimensions
in mm

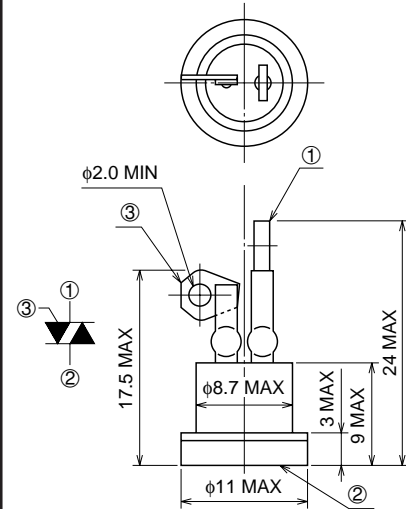

- ① T₁ TERMINAL
- ② T₂ TERMINAL
- ③ GATE TERMINAL

BCR20A

APPLICATION

Contactless AC switches, light dimmer,
on/off control of traffic signals, on/off control of copier lamps, microwave ovens,
solid state relay

MAXIMUM RATINGS

Symbol	Parameter	Voltage class		Unit
		8	12	
V_{DRM}	Repetitive peak off-state voltage*1	400	500	V
V_{DSM}	Non-repetitive peak off-state voltage*1	600	700	V

Symbol	Parameter	Conditions		Ratings	Unit
		BCR20A, B, C	BCR20E		
I_T (RMS)	RMS on-state current	Commercial frequency, sine full wave, 360° conduction	$T_c=98^\circ\text{C}$	20	A
			$T_b=64^\circ\text{C}$		
I_{TSM}	Surge on-state current	60Hz sinewave 1 full cycle, peak value, non-repetitive		220	A
I^2_t	I^2_t for fusing	Value corresponding to 1 cycle of half wave 60Hz, surge on-state current		203	A ² s
PGM	Peak gate power dissipation			5.0	W
PG (AV)	Average gate power dissipation			0.5	W
VGM	Peak gate voltage			10	V
IGM	Peak gate current			2.0	A
T_j	Junction temperature			-20 ~ +125	°C
T_{stg}	Storage temperature			-20 ~ +125	°C

*1. Gate open.

BCR20A, BCR20B, BCR20C, BCR20E

MEDIUM POWER USE

A, B, C : NON-INSULATED TYPE, E : INSULATED TYPE, GLASS PASSIVATION TYPE

MAXIMUM RATINGS (continue)

Symbol	Parameter	Conditions	Ratings	Unit
—	Weight (Typical value)	BCR20A	3.5	g
		BCR20B	9.0	
		BCR20C	9.0	
		BCR20E	11	
—	Soldering temperature	BCR20A only, 10 sec.	230	°C
—	Mounting torque	BCR20C only	30	kg-cm
			2.94	N-m
Viso	Isolated voltage	BCR20E only, Ta=25°C, AC 1 minute, T2 terminal to base	1500	V

ELECTRICAL CHARACTERISTICS

Symbol	Parameter	Test conditions	Limits			Unit	
			Min.	Typ.	Max.		
IDRM	Repetitive peak off-state current	Tj=125°C, VDRM applied	—	—	3.0	mA	
V _{TM}	On-state voltage	Tc=25°C, Tb=25°C (BCR20E only), I _{TM} =30A, Instantaneous measurement	—	—	1.5	V	
V _{FGT I}	Gate trigger voltage *2	Tj=25°C, V _D =6V, R _L =6Ω, R _G =330Ω	I	—	—	1.5	V
V _{RGT I}			II	—	—	1.5	V
V _{RGT III}			III	—	—	1.5	V
I _{FGT I}	Gate trigger current *2	Tj=25°C, V _D =6V, R _L =6Ω, R _G =330Ω	I	—	—	30	mA
I _{RGT I}			II	—	—	30	mA
I _{RGT III}			III	—	—	30	mA
V _{GD}	Gate non-trigger voltage	Tj=125°C, V _D =1/2V _{DRM}	0.2	—	—	V	
R _{th (j-c)}	Thermal resistance	Junction to case (BCR20A, BCR20B, BCR20C)	—	—	1.1	°C/W	
R _{th (j-b)}		Junction to base (BCR20E)	—	—	2.4	°C/W	
(dv/dt) _c	Critical-rate of rise of off-state commutating voltage		*3	—	—	V/μs	

*2. Measurement using the gate trigger characteristics measurement circuit.

*3. The critical-rate of rise of the off-state commutating voltage is shown in the table below.

Voltage class	V _{DRM} (V)	(dv/dt) _c			Test conditions	Commutating voltage and current waveforms (inductive load)
		Symbol	Min.	Unit		
8	400	R	—	V/μs	1. Junction temperature T _j =125°C 2. Rate of decay of on-state commutating current (di/dt) _c =-10A/ms 3. Peak off-state voltage V _D =400V	
		L	10			
10	600	R	—			
		L	10			

BCR20A, BCR20B, BCR20C, BCR20E

MEDIUM POWER USE

A, B, C : NON-INSULATED TYPE, E : INSULATED TYPE, GLASS PASSIVATION TYPE

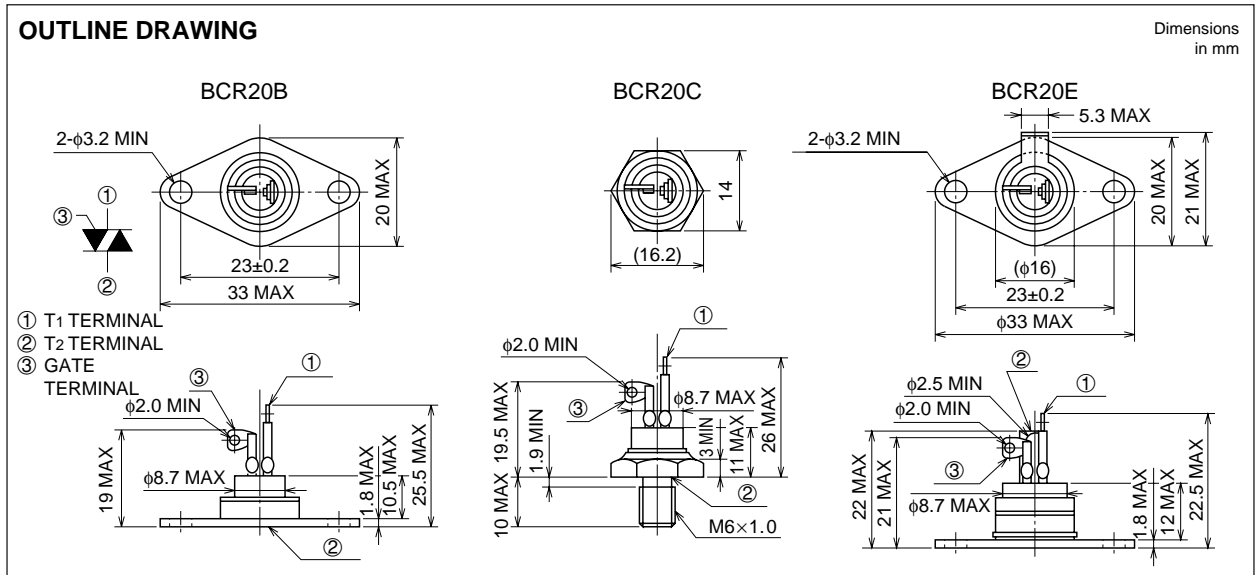

PERFORMANCE CURVES

MAXIMUM ON-STATE CHARACTERISTICS

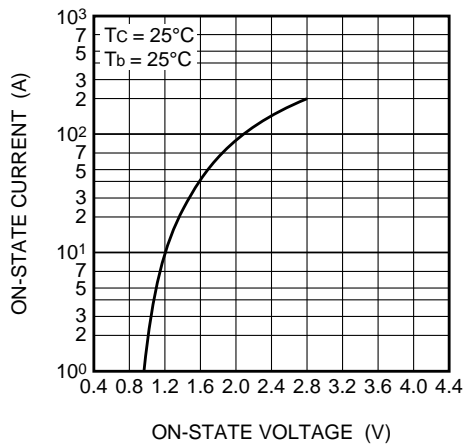

RATED SURGE ON-STATE CURRENT

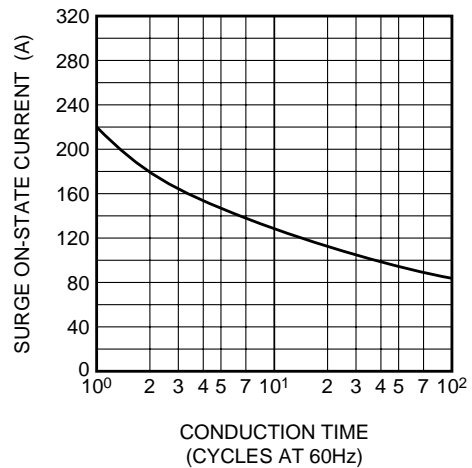

GATE CHARACTERISTICS

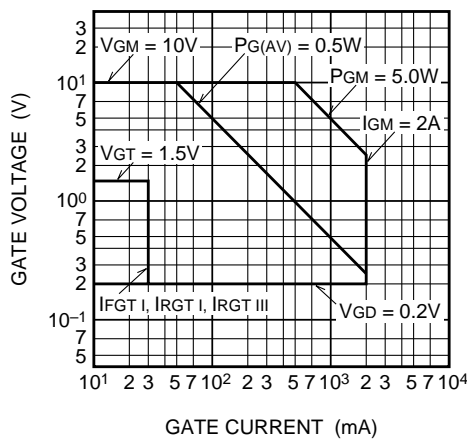

GATE TRIGGER CURRENT-VOLTAGE VS. JUNCTION TEMPERATURE

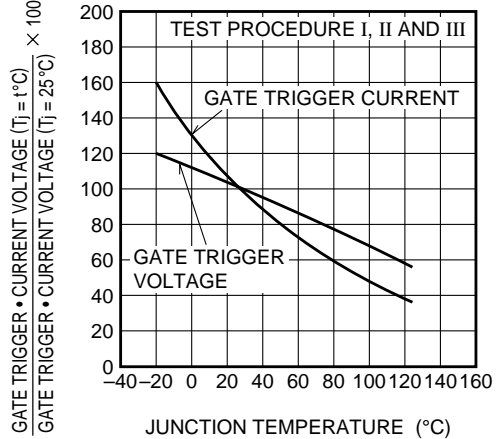

BCR20A, BCR20B, BCR20C, BCR20E

MEDIUM POWER USE

A, B, C : NON-INSULATED TYPE, E : INSULATED TYPE, GLASS PASSIVATION TYPE

MAXIMUM TRANSIENT THERMAL IMPEDANCE CHARACTERISTICS (JUNCTION TO CASE) (BCR20A, B, C)

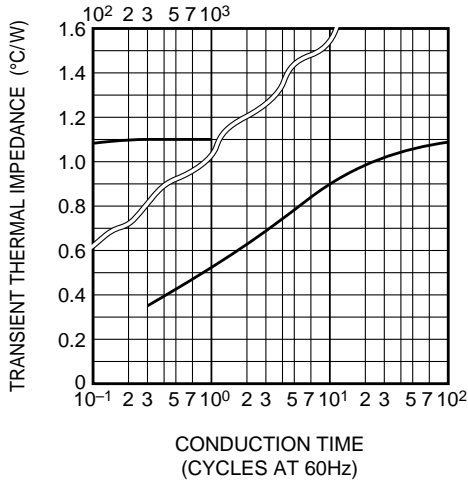

MAXIMUM TRANSIENT THERMAL IMPEDANCE CHARACTERISTICS (JUNCTION TO BASE) (BCR20E)

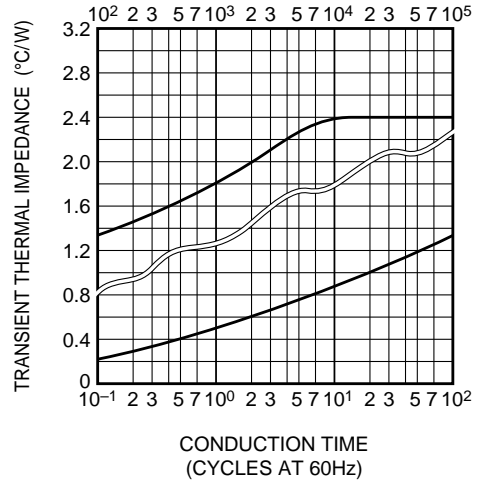

MAXIMUM ON-STATE POWER DISSIPATION

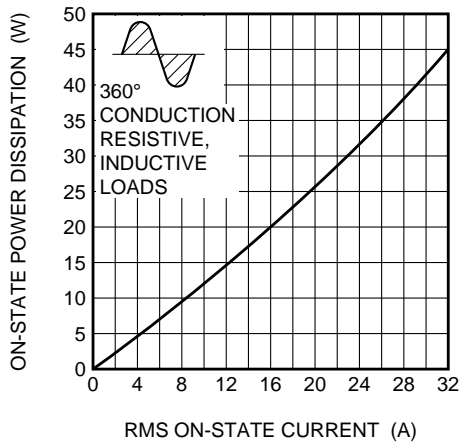

ALLOWABLE CASE TEMPERATURE VS. RMS ON-STATE CURRENT

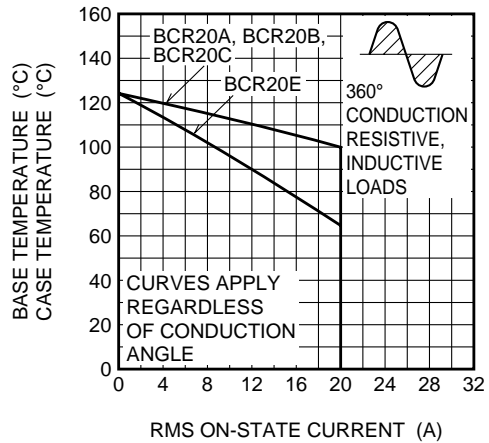

ALLOWABLE AMBIENT TEMPERATURE VS. RMS ON-STATE CURRENT (BCR20A)

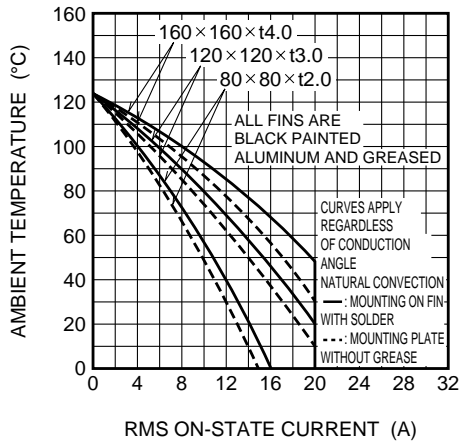

ALLOWABLE AMBIENT TEMPERATURE VS. RMS ON-STATE CURRENT (BCR20B)

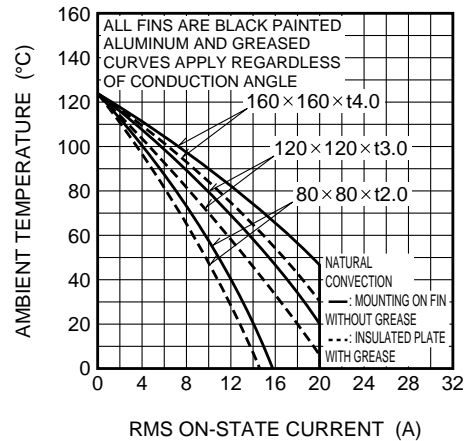

BCR20A, BCR20B, BCR20C, BCR20E

MEDIUM POWER USE

A, B, C : NON-INSULATED TYPE, E : INSULATED TYPE, GLASS PASSIVATION TYPE

**ALLOWABLE AMBIENT TEMPERATURE
VS. RMS ON-STATE CURRENT
(BCR20C)**

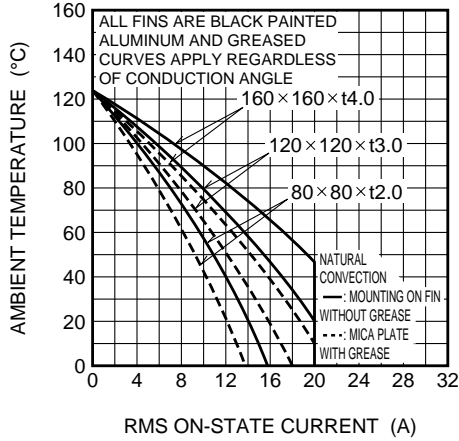

**ALLOWABLE AMBIENT TEMPERATURE
VS. RMS ON-STATE CURRENT
(BCR20E)**

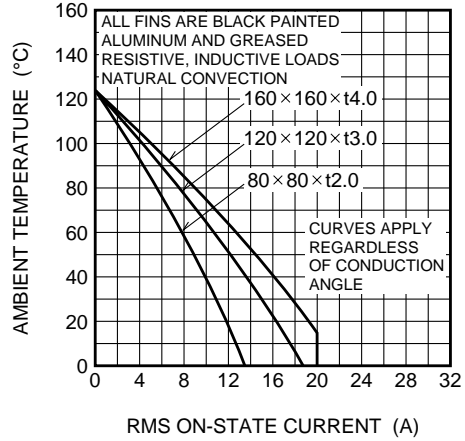

GATE TRIGGER CHARACTERISTICS TEST CIRCUITS

