



NEC's NPN SILICON TRANSISTOR

NE687M13

FEATURES

- **NEW MINIATURE M13 PACKAGE:**
 - Small transistor outline
 - 1.0 X 0.5 X 0.5 mm
 - Low profile / 0.50 mm package height
 - Flat lead style for better RF performance
- **HIGH GAIN BANDWIDTH PRODUCT:**
 $f_T = 14 \text{ GHz}$
- **LOW NOISE FIGURE:**
 $NF = 1.4 \text{ dB at } 2 \text{ GHz}$

DESCRIPTION

NEC's NE687M13 transistor is designed for low noise, high gain, and low cost requirements. This high f_T part is well suited for very low voltage/low current designs for portable wireless communications and cellular radio applications. NEC's new low profile/flat lead style "M13" package is ideal for today's portable wireless applications.

OUTLINE DIMENSIONS (Units in mm)

PACKAGE OUTLINE M13

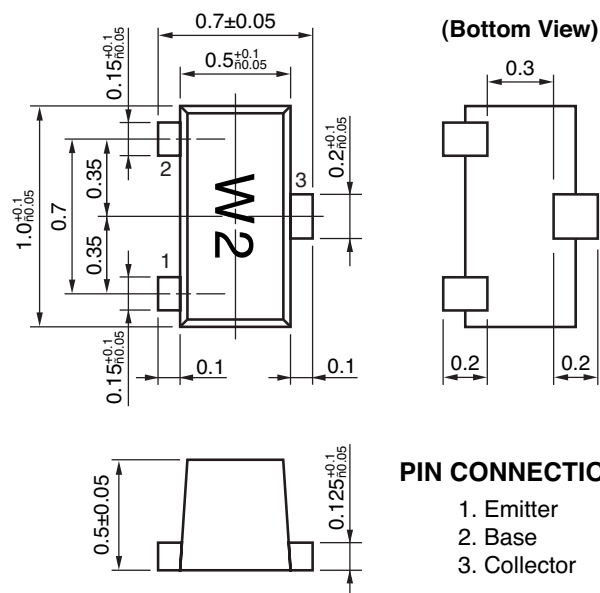

PIN CONNECTIONS

1. Emitter
2. Base
3. Collector

ELECTRICAL CHARACTERISTICS ($T_A = 25^\circ\text{C}$)

PART NUMBER EIAJ ¹ REGISTERED NUMBER PACKAGE OUTLINE		NE687M13 2SC5618 M13			
SYMBOLS	PARAMETERS AND CONDITIONS	UNITS	MIN	TYP	MAX
f_T	Gain Bandwidth at $V_{CE} = 2 \text{ V}$, $I_C = 20 \text{ mA}$, $f = 2 \text{ GHz}$ $V_{CE} = 1 \text{ V}$, $I_C = 10 \text{ mA}$, $f = 2 \text{ GHz}$	GHz	9.0	14.0	
		GHz	7.0	12.0	
NF	Noise Figure at $V_{CE} = 2 \text{ V}$, $I_C = 3 \text{ mA}$, $f = 2 \text{ GHz}$, $Z_s = Z_{opt}$ $V_{CE} = 1 \text{ V}$, $I_C = 3 \text{ mA}$, $f = 2 \text{ GHz}$, $Z_s = Z_{opt}$	dB		1.4	2.0
		dB		1.5	2.0
IS_{21E}^2	Insertion Power Gain at $V_{CE} = 2 \text{ V}$, $I_C = 20 \text{ mA}$, $f = 2 \text{ GHz}$ $V_{CE} = 1 \text{ V}$, $I_C = 10 \text{ mA}$, $f = 2 \text{ GHz}$	dB	8.5	10.0	
		dB	6.0	9.0	
h_{FE}	Forward Current Gain at $V_{CE} = 2 \text{ V}$, $I_C = 20 \text{ mA}$, ^{Note 2}		70		130
I_{CBO}	Collector Cutoff Current at $V_{CB} = 5 \text{ V}$, $I_E = 0$	μA			0.1
I_{EBO}	Emitter Cutoff Current at $V_{EB} = 1 \text{ V}$, $I_C = 0$	μA			0.1
CRE	Feedback Capacitance at $V_{CB} = 2 \text{ V}$, $I_E = 0$, $f = 1 \text{ MHz}$, ^{Note 3}	pF		0.4	0.8

Notes:

1. Electronic Industrial Association of Japan.
2. Pulsed measurement, pulse width $\leq 350 \mu\text{s}$, duty cycle $\leq 2\%$.
3. Capacitance is measured with emitter and case connected to the guard terminal of the bridge.

ABSOLUTE MAXIMUM RATINGS¹ (T_A = 25°C)

SYMBOLS	PARAMETERS	UNITS	RATINGS
V _{CB0}	Collector to Base Voltage	V	5.0
V _{CE0}	Collector to Emitter Voltage	V	3.0
V _{EB0}	Emitter to Base Voltage	V	2.0
I _C	Collector Current	mA	30
P _T	Total Power Dissipation ²	mW	90
T _J	Junction Temperature	°C	150
T _{STG}	Storage Temperature	°C	-65 to +150

Notes:

1. Operation in excess of any one of these parameters may result in permanent damage.
2. With device mounted on 1.08 cm² X 1.2 mm glass epoxy board.

ORDERING INFORMATION

PART NUMBER	QUANTITY
NE687M13-A	
NE687M13-T3-A	

TYPICAL PERFORMANCE CURVES (T_A = 25°C)

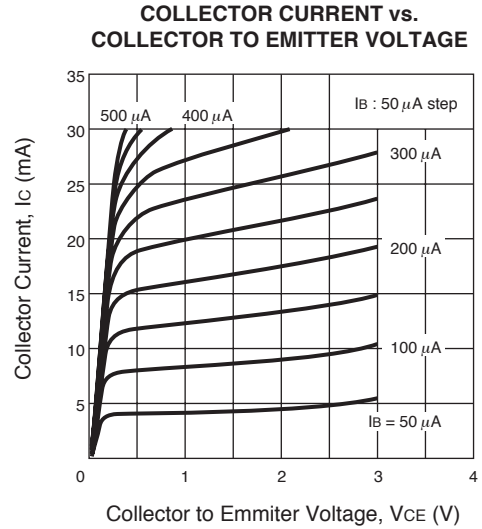
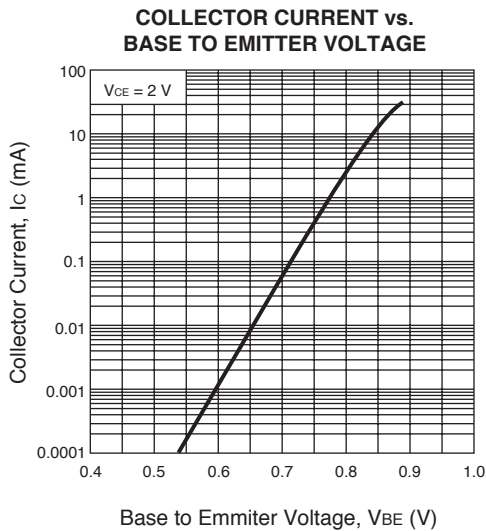
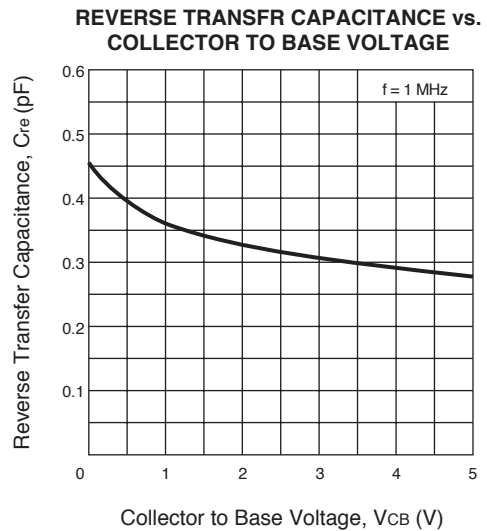
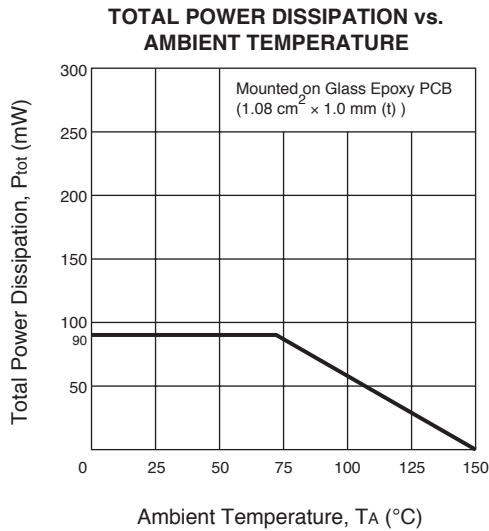

TYPICAL PERFORMANCE CURVES ($T_A = 25^\circ\text{C}$)

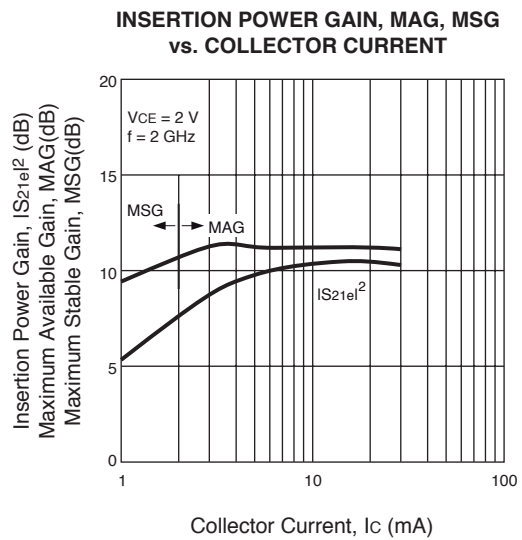
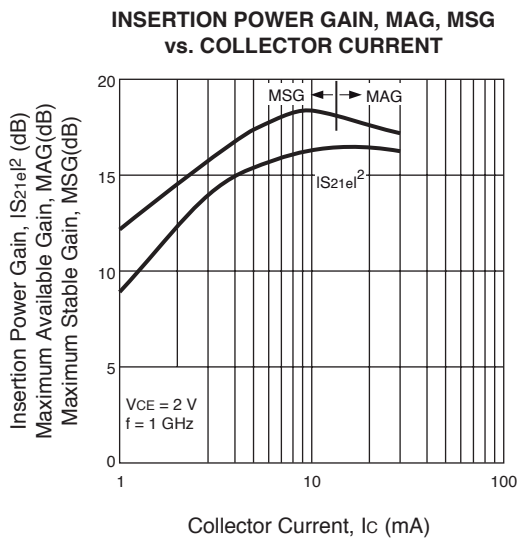
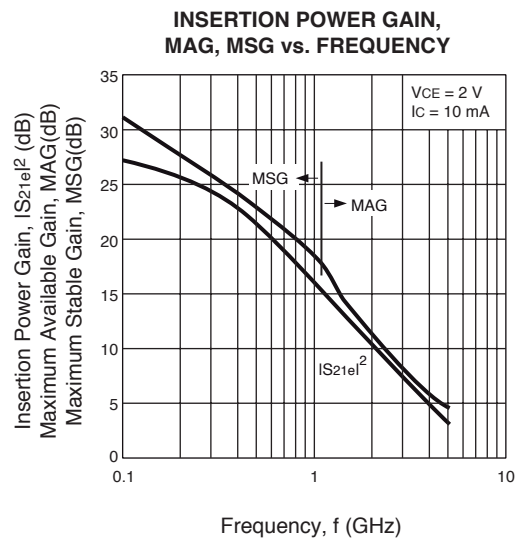
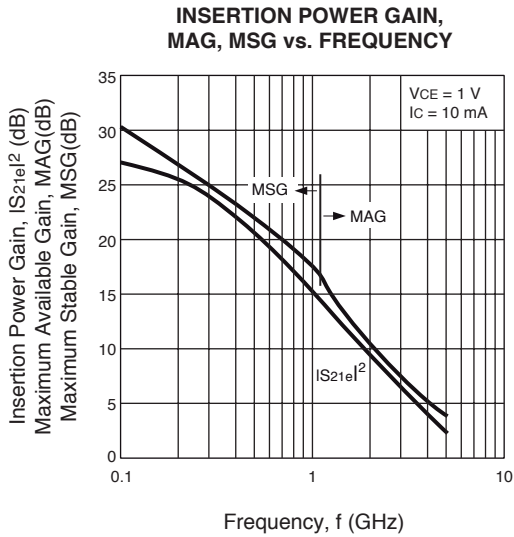
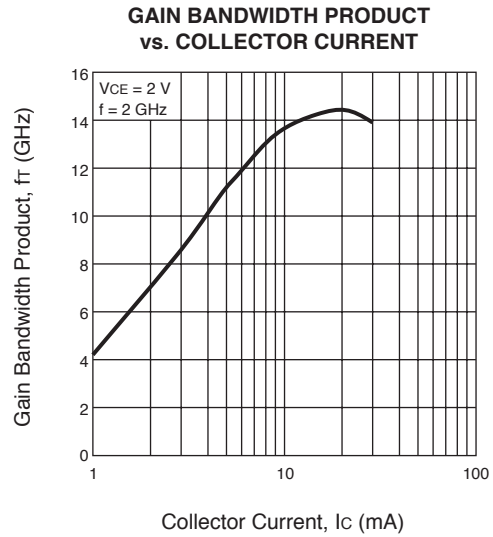
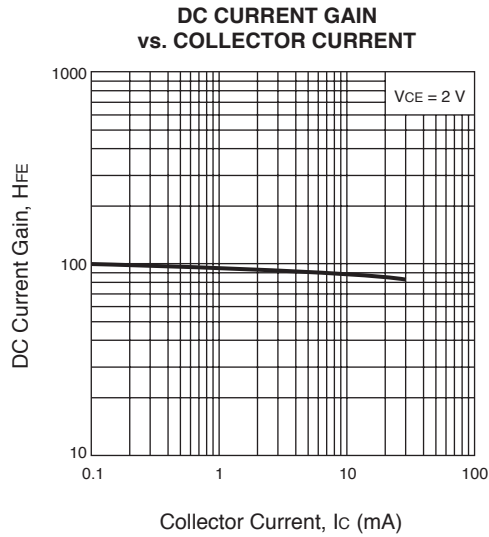

TYPICAL PERFORMANCE CURVES (T_A = 25°C)

NOISE FIGURE, ASSOCIATED GAIN vs. COLLECTOR CURRENT

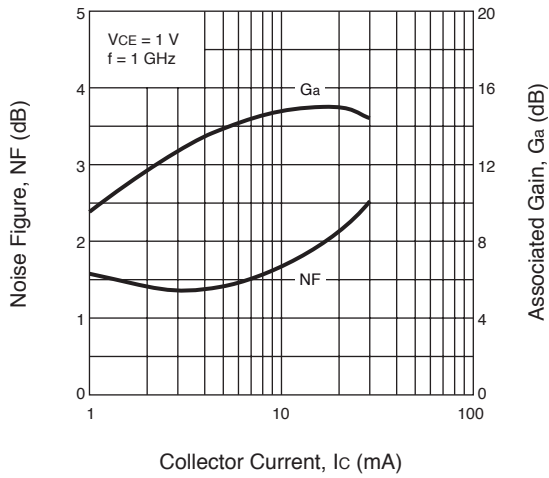

NOISE FIGURE, ASSOCIATED GAIN vs. COLLECTOR CURRENT

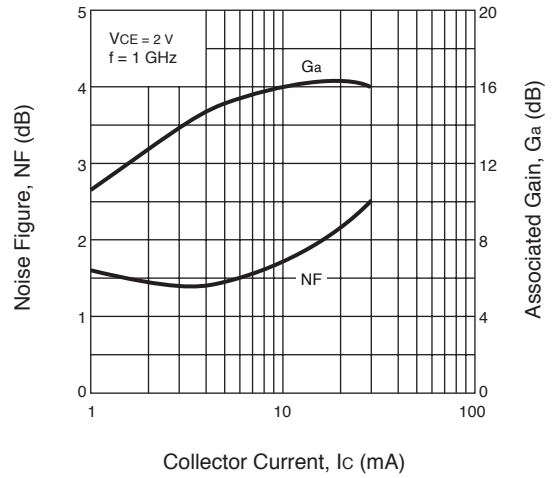

NOISE FIGURE, ASSOCIATED GAIN vs. COLLECTOR CURRENT

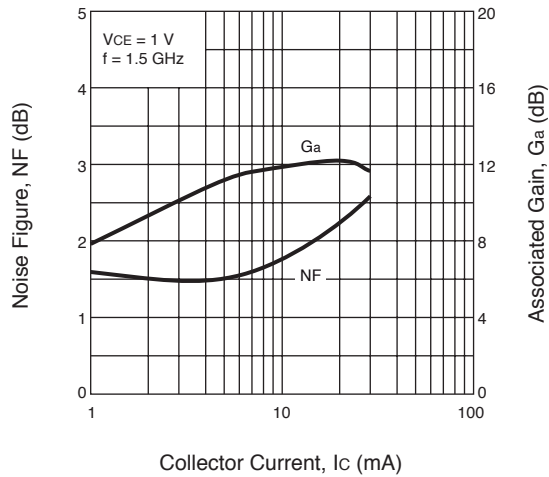

NOISE FIGURE, ASSOCIATED GAIN vs. COLLECTOR CURRENT

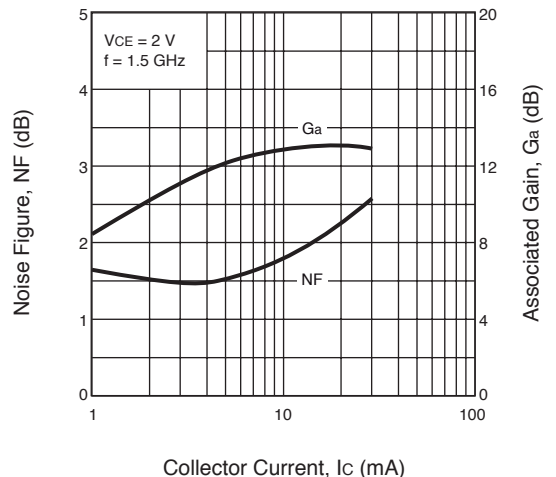

NOISE FIGURE, ASSOCIATED GAIN vs. COLLECTOR CURRENT

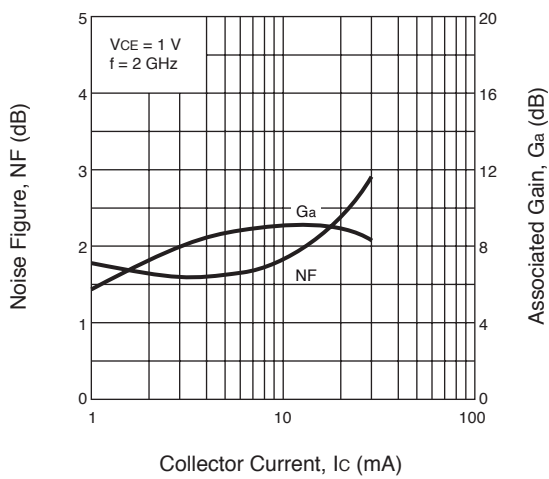

NOISE FIGURE, ASSOCIATED GAIN vs. COLLECTOR CURRENT

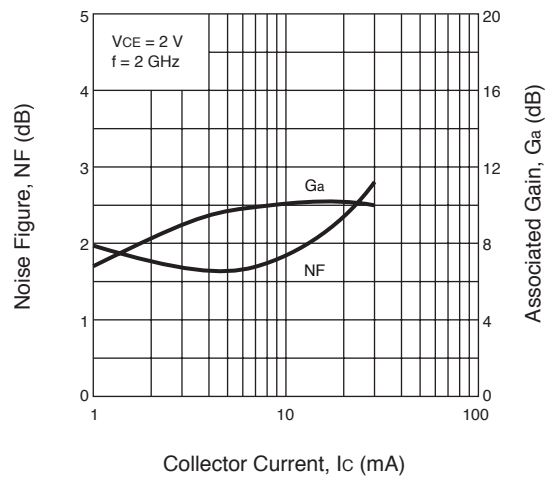

TYPICAL SCATTERING PARAMETERS

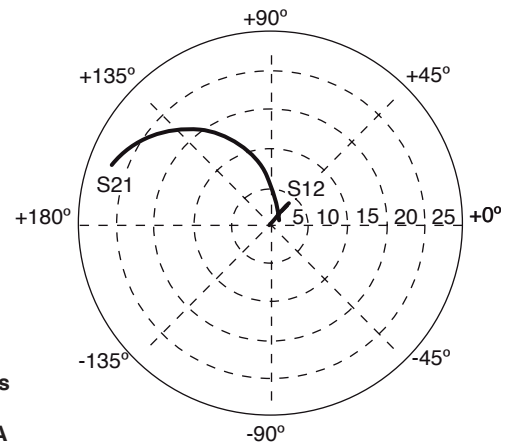
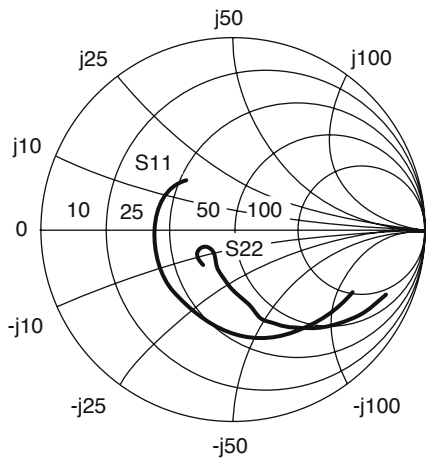

Coordinates in Ohms
Frequency in GHz
VCE = 1 V, Ic = 10 mA

NE687M13
VCE = 1 V, Ic = 10 mA

Frequency GHz	S11		S21		S12		S22		K	MAG ¹ (dB)
	MAG	ANG	MAG	ANG	MAG	ANG	MAG	ANG		
0.100	0.71	-28.83	21.86	158.87	0.02	76.89	0.86	-22.59	0.19	29.94
0.200	0.64	-56.70	19.01	141.86	0.04	64.05	0.75	-40.78	0.28	27.02
0.300	0.57	-77.87	16.05	129.44	0.05	57.48	0.63	-54.59	0.37	25.16
0.400	0.53	-94.58	13.57	120.29	0.06	54.28	0.54	-64.96	0.46	23.79
0.500	0.49	-107.39	11.62	113.50	0.06	52.33	0.47	-72.99	0.54	22.68
0.600	0.45	-120.85	9.91	108.06	0.07	51.39	0.37	-78.86	0.68	21.71
0.700	0.44	-129.42	8.73	103.77	0.07	51.70	0.33	-85.54	0.74	20.83
0.800	0.44	-135.99	7.80	100.31	0.08	52.15	0.30	-90.17	0.79	20.04
0.900	0.43	-141.83	7.02	97.30	0.08	52.52	0.28	-94.31	0.83	19.34
1.000	0.43	-146.64	6.38	94.61	0.09	53.11	0.26	-99.34	0.88	18.67
1.200	0.42	-153.87	5.40	90.05	0.10	54.26	0.23	-106.29	0.94	17.49
1.400	0.42	-160.59	4.69	86.18	0.11	55.29	0.21	-113.29	0.99	16.45
1.600	0.42	-165.22	4.14	82.82	0.12	56.05	0.19	-118.74	1.03	14.43
1.800	0.42	-169.18	3.71	79.73	0.13	56.51	0.18	-123.68	1.06	13.15
2.000	0.41	-172.49	3.37	76.86	0.14	56.83	0.17	-128.17	1.08	12.13
2.500	0.40	179.29	2.76	70.23	0.16	56.91	0.16	-136.91	1.12	10.14
3.000	0.40	171.08	2.35	64.05	0.19	55.87	0.17	-143.47	1.14	8.61
3.500	0.39	161.33	2.05	58.49	0.21	54.71	0.18	-147.06	1.16	7.38
4.000	0.40	152.78	1.83	53.56	0.24	53.37	0.20	-147.25	1.16	6.41
4.500	0.39	146.02	1.66	49.23	0.26	52.04	0.22	-144.73	1.16	5.60
5.000	0.38	141.59	1.53	45.35	0.29	50.81	0.23	-140.61	1.15	4.94
5.500	0.36	138.25	1.44	41.63	0.31	49.38	0.23	-135.48	1.14	4.40
6.000	0.34	134.43	1.36	37.72	0.34	47.54	0.23	-133.06	1.13	3.90

Note:

1. Gain Calculations:

$$MAG = \frac{|S_{21}|}{|S_{12}|} (K \pm \sqrt{K^2 - 1}). \text{ When } K \leq 1, \text{ MAG is undefined and MSG values are used. } MSG = \frac{|S_{21}|}{|S_{12}|}, K = \frac{1 + |\Delta|^2 - |S_{11}|^2 - |S_{22}|^2}{2 |S_{12} S_{21}|}, \Delta = S_{11} S_{22} - S_{21} S_{12}$$

MAG = Maximum Available Gain

MSG = Maximum Stable Gain

TYPICAL SCATTERING PARAMETERS

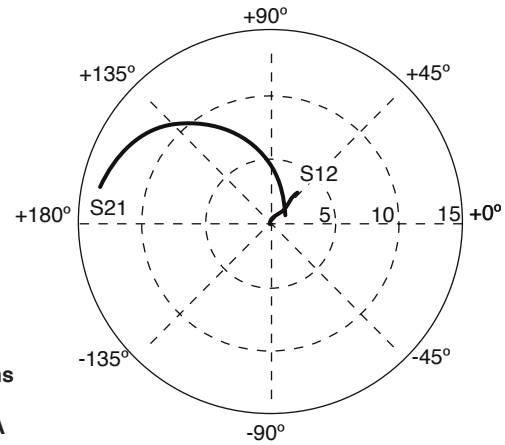
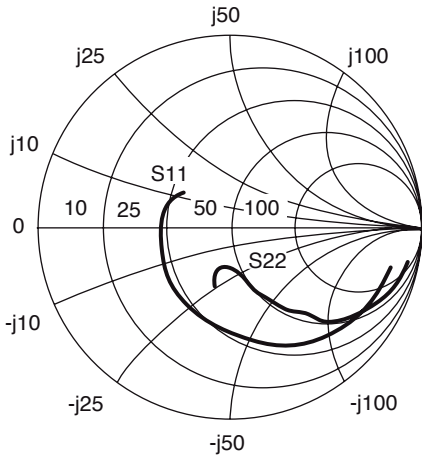

Coordinates in Ohms
Frequency in GHz
VCE = 2 V, IC = 5 mA

NE687M13
VCE = 2 V, IC = 5 mA

Frequency GHz	S11		S21		S12		S22		K	MAG ¹ (dB)
	MAG	ANG	MAG	ANG	MAG	ANG	MAG	ANG		
0.100	0.86	-14.28	13.53	167.49	0.02	80.25	0.94	-11.88	0.14	28.47
0.200	0.81	-31.85	12.83	155.13	0.04	71.73	0.89	-22.74	0.17	25.34
0.300	0.76	-46.05	11.91	144.78	0.05	65.56	0.82	-32.21	0.22	23.61
0.400	0.70	-59.23	10.91	135.97	0.06	60.40	0.75	-39.96	0.28	22.37
0.500	0.65	-70.68	9.95	128.54	0.07	56.24	0.68	-46.33	0.34	21.38
0.600	0.58	-82.92	8.87	121.33	0.08	52.47	0.58	-49.51	0.47	20.54
0.700	0.54	-91.97	8.07	116.01	0.08	50.58	0.53	-54.17	0.52	19.81
0.800	0.52	-99.97	7.39	111.61	0.09	49.44	0.48	-57.43	0.57	19.16
0.900	0.49	-107.10	6.76	107.73	0.09	48.55	0.44	-59.80	0.62	18.56
1.000	0.48	-113.24	6.24	104.20	0.10	47.85	0.41	-63.07	0.66	18.02
1.200	0.45	-123.52	5.38	98.29	0.11	47.62	0.36	-66.56	0.75	17.05
1.400	0.43	-132.69	4.72	93.40	0.11	47.64	0.32	-70.62	0.82	16.19
1.600	0.41	-139.56	4.20	89.17	0.12	48.14	0.29	-73.13	0.88	15.41
1.800	0.40	-145.30	3.78	85.45	0.13	48.60	0.27	-75.54	0.94	14.70
2.000	0.39	-150.12	3.45	82.00	0.14	49.16	0.25	-77.78	0.98	14.05
2.500	0.37	-161.26	2.84	74.35	0.16	50.11	0.22	-83.87	1.07	11.05
3.000	0.36	-171.52	2.42	67.39	0.18	50.31	0.21	-91.33	1.12	9.30
3.500	0.35	176.69	2.12	61.12	0.20	50.27	0.22	-98.64	1.15	7.96
4.000	0.34	166.32	1.88	55.53	0.22	49.84	0.23	-104.18	1.17	6.92
4.500	0.34	158.42	1.70	50.63	0.23	49.50	0.26	-106.91	1.18	6.08
5.000	0.34	153.42	1.56	46.37	0.25	49.25	0.28	-106.70	1.17	5.40
5.500	0.32	150.03	1.46	42.49	0.27	48.86	0.30	-104.89	1.16	4.85
6.000	0.30	146.33	1.38	38.57	0.30	48.07	0.31	-104.37	1.15	4.35

Note:

1. Gain Calculations:

$$MAG = \frac{|S_{21}|}{|S_{12}|} (K \pm \sqrt{K^2 - 1}). \text{ When } K \leq 1, \text{ MAG is undefined and MSG values are used. } MSG = \frac{|S_{21}|}{|S_{12}|}, K = \frac{1 + |\Delta|^2 - |S_{11}|^2 - |S_{22}|^2}{2 |S_{12} S_{21}|}, \Delta = S_{11} S_{22} - S_{21} S_{12}$$

MAG = Maximum Available Gain
MSG = Maximum Stable Gain

TYPICAL SCATTERING PARAMETERS

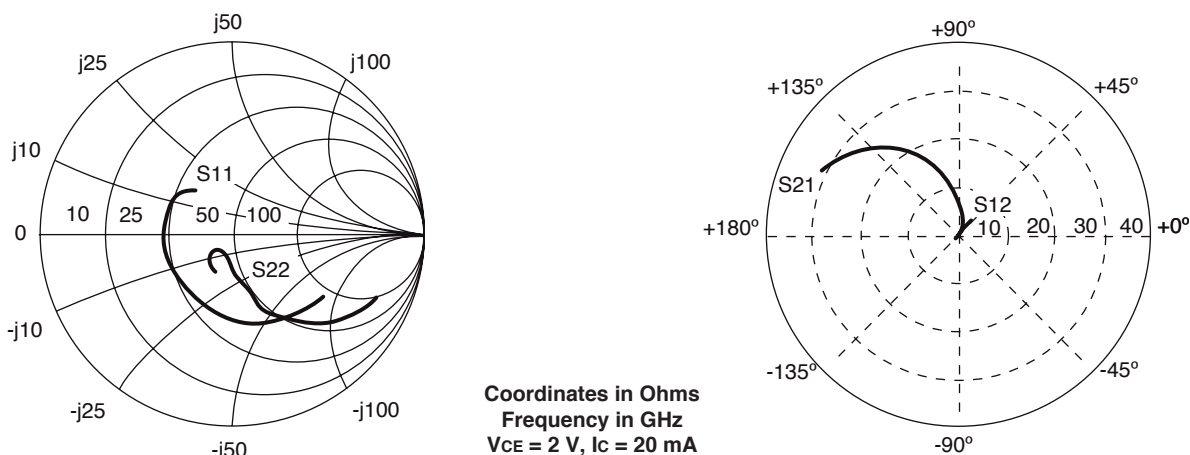

NE687M13

V_{CE} = 2 V, I_c = 20 mA

Frequency GHz	S ₁₁		S ₂₁		S ₁₂		S ₂₂		K	MAG ¹ (dB)
	MAG	ANG	MAG	ANG	MAG	ANG	MAG	ANG		
0.100	0.57	-36.15	31.49	154.52	0.01	71.95	0.81	-25.05	0.34	33.26
0.200	0.50	-67.88	25.71	135.92	0.03	66.14	0.67	-43.58	0.42	29.76
0.300	0.45	-90.13	20.68	123.67	0.03	60.45	0.54	-56.22	0.54	27.77
0.400	0.42	-106.56	16.96	115.24	0.04	59.44	0.46	-64.85	0.64	26.19
0.500	0.40	-118.50	14.25	109.26	0.05	59.55	0.39	-71.22	0.71	24.88
0.600	0.37	-131.65	12.07	104.60	0.05	60.02	0.30	-75.54	0.84	23.77
0.700	0.37	-139.21	10.55	100.88	0.06	60.94	0.26	-81.03	0.89	22.75
0.800	0.37	-144.73	9.37	97.86	0.06	61.83	0.24	-84.22	0.92	21.84
0.900	0.37	-149.66	8.41	95.24	0.07	62.31	0.21	-87.05	0.95	21.02
1.000	0.36	-153.80	7.62	92.90	0.07	62.97	0.20	-91.25	0.98	20.26
1.200	0.37	-159.66	6.43	88.88	0.08	63.94	0.17	-96.57	1.02	18.15
1.400	0.37	-165.38	5.56	85.48	0.09	64.61	0.15	-102.15	1.05	16.47
1.600	0.37	-169.31	4.90	82.45	0.10	64.72	0.14	-106.18	1.07	15.17
1.800	0.37	-172.61	4.39	79.67	0.11	64.87	0.13	-109.91	1.08	14.10
2.000	0.36	-175.37	3.98	77.07	0.13	64.81	0.12	-113.45	1.09	13.16
2.500	0.36	177.29	3.24	70.97	0.15	63.80	0.11	-121.12	1.11	11.27
3.000	0.35	169.69	2.75	65.26	0.18	62.10	0.12	-128.22	1.12	9.76
3.500	0.35	160.03	2.39	60.01	0.21	60.09	0.14	-133.08	1.12	8.53
4.000	0.36	151.53	2.12	55.28	0.23	58.20	0.16	-134.34	1.12	7.54
4.500	0.36	144.75	1.92	51.05	0.25	56.51	0.18	-132.06	1.12	6.71
5.000	0.35	140.37	1.76	47.24	0.28	54.88	0.20	-127.09	1.11	6.03
5.500	0.33	137.20	1.65	43.56	0.30	53.20	0.21	-120.86	1.10	5.48
6.000	0.31	133.76	1.55	39.78	0.33	51.20	0.21	-117.44	1.09	4.95

Note:

1. Gain Calculations:

$$MAG = \frac{|S_{21}|}{|S_{12}|} (K \pm \sqrt{K^2 - 1}). \text{ When } K \leq 1, \text{ MAG is undefined and MSG values are used. } MSG = \frac{|S_{21}|}{|S_{12}|}, K = \frac{1 + |\Delta|^2 - |S_{11}|^2 - |S_{22}|^2}{2 |S_{12} S_{21}|}, \Delta = S_{11} S_{22} - S_{21} S_{12}$$

MAG = Maximum Available Gain

MSG = Maximum Stable Gain

Life Support Applications

These NEC products are not intended for use in life support devices, appliances, or systems where the malfunction of these products can reasonably be expected to result in personal injury. The customers of CEL using or selling these products for use in such applications do so at their own risk and agree to fully indemnify CEL for all damages resulting from such improper use or sale.

EXCLUSIVE NORTH AMERICAN AGENT FOR NEC RF, MICROWAVE & OPTOELECTRONIC SEMICONDUCTORS

CEL CALIFORNIA EASTERN LABORATORIES • Headquarters • 4590 Patrick Henry Drive • Santa Clara, CA 95054-1817 • (408) 988-3500 • Telex 34-6393 • FAX (408) 988-0279
DATA SUBJECT TO CHANGE WITHOUT NOTICE Internet: <http://WWW.CEL.COM>

06/13/2002

Subject: Compliance with EU Directives

CEL certifies, to its knowledge, that semiconductor and laser products detailed below are compliant with the requirements of European Union (EU) Directive 2002/95/EC Restriction on Use of Hazardous Substances in electrical and electronic equipment (RoHS) and the requirements of EU Directive 2003/11/EC Restriction on Penta and Octa BDE.

CEL Pb-free products have the same base part number with a suffix added. The suffix –A indicates that the device is Pb-free. The –AZ suffix is used to designate devices containing Pb which are exempted from the requirement of RoHS directive (*). In all cases the devices have Pb-free terminals. All devices with these suffixes meet the requirements of the RoHS directive.

This status is based on CEL’s understanding of the EU Directives and knowledge of the materials that go into its products as of the date of disclosure of this information.

Restricted Substance per RoHS	Concentration Limit per RoHS (values are not yet fixed)	Concentration contained in CEL devices	
		-A	-AZ
Lead (Pb)	< 1000 PPM	Not Detected	(*)
Mercury	< 1000 PPM	Not Detected	
Cadmium	< 100 PPM	Not Detected	
Hexavalent Chromium	< 1000 PPM	Not Detected	
PBB	< 1000 PPM	Not Detected	
PBDE	< 1000 PPM	Not Detected	

If you should have any additional questions regarding our devices and compliance to environmental standards, please do not hesitate to contact your local representative.

Important Information and Disclaimer: Information provided by CEL on its website or in other communications concerning the substance content of its products represents knowledge and belief as of the date that it is provided. CEL bases its knowledge and belief on information provided by third parties and makes no representation or warranty as to the accuracy of such information. Efforts are underway to better integrate information from third parties. CEL has taken and continues to take reasonable steps to provide representative and accurate information but may not have conducted destructive testing or chemical analysis on incoming materials and chemicals. CEL and CEL suppliers consider certain information to be proprietary, and thus CAS numbers and other limited information may not be available for release.

In no event shall CEL’s liability arising out of such information exceed the total purchase price of the CEL part(s) at issue sold by CEL to customer on an annual basis.

See CEL Terms and Conditions for additional clarification of warranties and liability.