



TDK SEMICONDUCTOR CORP.

78P2254 STM-1/STS-3 Transceiver

JUNE 2002

DESCRIPTION

The 78P2254 is a transceiver IC designed for 155.52Mbit/s (STS-3 or STM-1) transmission. It is used at the interface to a 75Ω coaxial cable using CMI coding. Interfacing to digital framer circuits is accomplished via a serial PECL or parallel CMOS interfaces.

The transmitter includes a PLL to multiply the reference clock to the transmission frequency. The receiver provides adaptive equalization for accurate clock and data recovery. The 78P2254 is built in a BiCMOS technology for high performance and low power operation. It operates with a 3.3V or 5V power supply and is packaged in a 64-pin TQFP.

FEATURES

- 155.52Mbit/s interface for CMI coded transmission using 75Ω coaxial cable
- Compliant with ITU-T G.703 and Telcordia TR-NWT-00253
- Integrated Clock Recovery Unit (CRU)
- Serial PECL Interface to Framer
- Four and Eight bit Parallel CMOS Interfaces to Framer
- Synchronous 311MHz clock generated by transmit PLO
- Adaptive Equalization
- Integrated Clock Multiplier PLL
- Advanced BiCMOS Process

BLOCK DIAGRAM

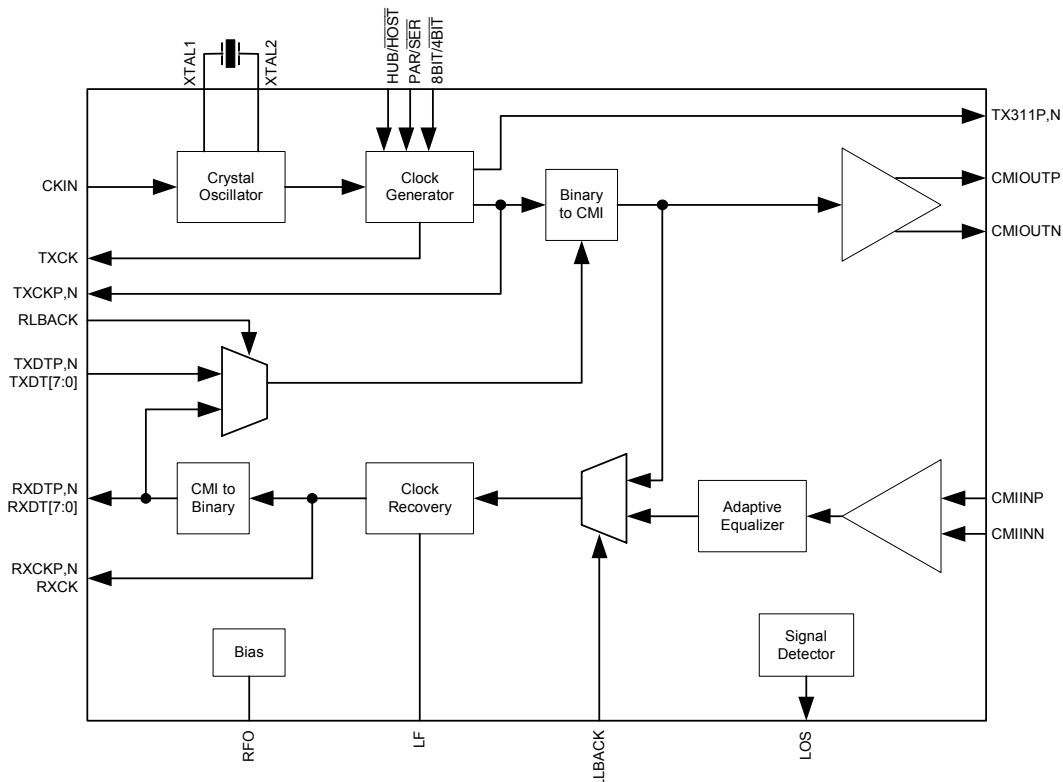

78P2254

STM-1/STS-3

Transceiver

FUNCTIONAL DESCRIPTION

The 78P2254 contains all the necessary transmit and receive circuitry for connection between 155.52Mbit/s signals and digital Framer/Deframer ICs.

OPERATING RATE

The line interface of the 78P2254 operates at STM1 or STS3 rates over coax. The digital interface of the 78P2254 can be either Serial PECL, 4-bit Parallel CMOS or 8-bit Parallel CMOS as described in the following table.

Mode	PAR/ SER	8BIT/ 4BIT	Data pins	Clock pins	Clock Frequency
Serial	0	X	TXDTP,N RXDTP,N	TXCKP,N RXCKP,N	155.52 MHz
4-bit Parallel	1	0	TXDT[3:0] RXDT[3:0]	TXCK RXCK	38.88 MHz
8-bit Parallel	1	1	TXDT[7:0] RXDT[7:0]	TXCK RXCK	19.44 MHz

Transmit timing is derived from either the reference clock (the crystal oscillator or CKIN), or the recovered receive clock. LLBACK and RLBACK control the local and remote loopback modes respectively.

LLBACK	RLBACK	HUB/HOST	Transmit Clock derived from
0	0	1	Reference
1	0	1	Reference
X	1	1	Receiver
X	X	0	Receiver

TRANSMITTER OPERATION

The transmitter section generates an analog signal for transmission through a transformer onto the coaxial cable.

When the PAR/SER pin is low, the chip is in serial mode. Serial data is input from the digital Framer/Deframer IC to the 78P2254 on the TXDTP and TXDTN pins at PECL levels. The data is timed with the clock generated by the 78P2254 on the TXCKP and TXCKN pins. In this mode the 8BIT/4BIT pin is ignored.

When the PAR/SER pin is high, the chip is in parallel mode. Parallel data is input from the digital Framer/Deframer IC to the 78P2254 on the TXDT[7:0] pins. The input data is timed with the transmit clock output from TXCK. When 8BIT/4BIT is high, all eight bits of TXDT[7:0] are used and the clock frequency at TXCK is one-eighth the standard frequency. When 8BIT/4BIT is low, the lower four bits, TXDT[3:0], are used and TXCK is one-fourth the standard frequency.

Note that the first bit output from the CMI interface (CMIOU_TP,N) is the most significant bit on the parallel interface, TXDT7 in eight bit mode, TXDT3 in four bit mode.

The clock is generated by a phase-locked oscillator (PLO). The PLO can be locked to a crystal oscillator operating at one-eighth of the standard clock frequency, 19.44MHz for STS-3 and STM-1. This is shown in Figure 1a. An external clock signal at CKIN may also be substituted for a crystal as the reference frequency for the chip. In this mode, XTAL1 and XTAL2 must be configured as shown in Figure 1b.

Note that in serial mode the reference clock is also output from TXCK. In parallel mode, the parallel transmit clock is output from TXCK.

The HUB/HOST input changes the reference signal for the clock generator. In the hub mode (HUB/HOST high), the transmit clock reference is derived from either the crystal oscillator or CKIN. In host mode (HUB/HOST low), the transmit clock reference is derived from the recovered receive clock.

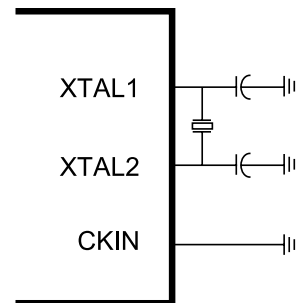

Figure 1a: Using Crystal

FUNCTIONAL DESCRIPTION (continued)

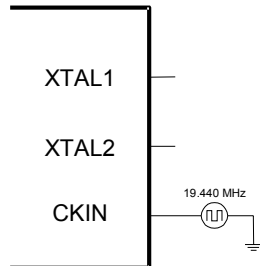

Figure 1b: Using External Clock

311 MHZ SERIAL CLOCK

The transmit PLO also generates a 311 MHz synchronous, differential clock on the TX311P and TX311N pins that can be used to recover the transmitted CMI signal data on the receiving unit. This clock complies with the same jitter specifications of the transmitter.

RECEIVER OPERATION

The receiver accepts serial, CMI coded data at 155.52Mbit/s from the CMI inputs. The inputs, CMIINP and CMIINN, receive the input signal from a coaxial cable that is transformer-coupled to the chip.

The clock signal is recovered using a low jitter PLL circuit. The received signal is equalized for dispersive cable attenuation and decoded in the CMI to binary decoder.

In serial mode, the received data is output on the RXDTP and RXDTN pins and the recovered clock is output on the RXCKP and RXCKN pins.

In parallel mode, the received data is converted to parallel, eight bits if 8BIT/4BIT is high and four if it is low. The first bit received will arrive on the most significant output pin, RXDT[7] in eight bit mode and RXDT3 in four bit mode. The recovered clock is output on the RXCK pin.

The LOS pin goes high when the signal detector detects a loss-of-signal condition.

LOOPBACK OPERATION

The 78P2254 is capable of performing signal loopback in two ways:

The RLBACK pin selects the remote loopback mode. In this mode, the received signal is “looped back” and sent out of transmitter in place of the transmit input signal.

The LLBACK pin selects the local loop-back mode, and causes the receiver to use the transmitter output signal as its input. Local loopback is disabled when HUB/HOST is low or RLBACK is high.

78P2254

STM-1/STS-3

Transceiver

PIN DESCRIPTION

LEGEND

TYPE	DESCRIPTION	TYPE	DESCRIPTION
A	Analog Pin	PI	PECL Digital Input
CI	CMOS Digital Input	PO	PECL Digital Output
CO	CMOS Digital Output	S	Supply Pin

TRANSMIT PINS

NAME	PIN	TYPE	DESCRIPTION
TXDTP TXDTN	19 20	PI	Transmit Data Inputs - Serial Mode.
TXCKP TXCKN	22 23	PO	Transmit Clock Output - Serial Mode.
TXDT[7:0]	11-18	CI	Transmit Data Inputs – Parallel Mode. TXDT[7:4] are ignored in 4 bit mode.
TXCK	10	CO	Reference Clock Output – Serial mode. Transmit Clock Output – Parallel Mode.
CMIOUTP CMIOUTN	60 59	A	Transmit Outputs .
TX311P TX311N	56 55	PO	Transmitted 311MHz clock (line side). Should be both tied to VCC when unused.

RECEIVE PINS

NAME	PIN	TYPE	DESCRIPTION
CMIINP CMIINN	50 49	A	Receive inputs. Transformer coupled from the coaxial cable.
RXCKP RXCKN	25 26	PO	Recovered Receive Clock – Serial Mode.
RXCK	38	CO	Recovered Receive Clock – Parallel Mode.
RXDTP RXDTN	27 28	PO	Receive data – Serial Mode.
RXDT[7:0]	30-37	CO	Receive data – Parallel Mode. In 4 bit mode RXDT[3:0] are used and RXDT[7:4] are pulled low.

REFERENCE CLOCK PINS

NAME	PIN	TYPE	DESCRIPTION
XTAL1 XTAL2	5 6	A	Crystal Pins. Connect as in Figure 1a.
CKIN	9	CI	Reference clock input. The crystal oscillator connections should be left open when used. Connect as in Figure 1b.

PIN DESCRIPTION (continued)

CONTROL AND STATUS PINS

NAME	PIN	TYPE	DESCRIPTION
RLBACK	41	CI	Loopback receiver output to transmitter input.
LLBACK	42	CI	Loopback transmitter output to receiver input. Disabled when HUB/HOST is low or RLBACK is high.
HUB/HOST	2	CI	In HUB mode (input high) the transmit reference clock is derived from the CKIN pin or the crystal oscillator. In HOST mode (input low) the transmit reference clock is derived from the recovered receive clock.
8BIT/4BIT	63	CI	Selects 8 bit parallel data when high and 4 bit parallel mode when low. In serial mode this pin is ignored.
PAR/SER	62	CI	Selects parallel mode when high and serial mode when low.
LOS	39	CO	High during a loss-of-signal condition.

ANALOG PINS

NAME	PIN	TYPE	DESCRIPTION
RFO	46	A	External reference resistor.
LF	44	A	PLL loop filter capacitor.

POWER SUPPLY PINS

It is recommended that all VCC pins be connected to a single power supply plane and all GND pins be connected to a single ground plane.

NAME	PIN	TYPE	DESCRIPTION
VCC	1, 3, 8, 24, 40, 43, 51, 52, 53, 54, 57	S	Power Supply.
GND	4, 7, 21, 29, 45, 47, 48, 58, 61, 64	S	Ground.

78P2254

STM-1/STS-3

Transceiver

ELECTRICAL SPECIFICATIONS

ABSOLUTE MAXIMUM RATINGS

Operation beyond these limits may permanently damage the device.

PARAMETER	RATING
Supply Voltage	7 VDC
Storage Temperature	-65 to 150° C
Pin Voltage	-0.3 to (Vcc+0.3) VDC
Pin Current	±100 mA

RECOMMENDED OPERATING CONDITIONS

Unless otherwise noted all specifications are valid over these temperatures and supply voltage ranges.

PARAMETER	RATING
DC Voltage Supply, VCC	3.3 ± 0.3 VDC; 5 ± 0.5 VDC
Ambient Operating Temperature	-40 to 85°C

DC CHARACTERISTICS:

PARAMETER	SYMBOL	CONDITIONS	MIN	NOM	MAX	UNIT
Supply Current (Parallel Mode)	Icc	Vcc = 3.3V		140	165	mA
		Vcc = 5.0V		150	175	
Supply Current (Serial Mode)	Icc	Vcc = 3.3V		210	245	mA
		Vcc = 5.0V		280	330	

78P2254
STM-1/STS-3
Transceiver

ELECTRICAL SPECIFICATIONS (continued)

DIGITAL INPUT CHARACTERISTICS

Pins of type CI

PARAMETER	SYMBOL	CONDITIONS	MIN	NOM	MAX	UNIT
Input Voltage Low	Vil		Vcc/2 - 0.9		Vcc/2 + 0.9	V
Input Voltage High	Vih		Vcc/2 - 0.9		Vcc/2 + 0.9	V
Input Current	Iil, Iih		-10		10	μA
Input Capacitance	Cin			10		pF

Pins of type PI

PARAMETER	SYMBOL	CONDITIONS	MIN	NOM	MAX	UNIT
Input Voltage Low	Vil	Relative to Vcc			-1.5	V
Input Voltage High	Vih	Relative to Vcc	-1.1			V

DIGITAL OUTPUT CHARACTERISTICS

Pins of type CO

PARAMETER	SYMBOL	CONDITIONS	MIN	NOM	MAX	UNIT
Output Voltage Low	Vol			0.6	0.7	V
Output Voltage High	Voh	Below Vcc		0.6	0.7	V
Transition Time	Tt			3.5		ns

Pins of type PO

PARAMETER	SYMBOL	CONDITIONS	MIN	NOM	MAX	UNIT
Output Voltage Low	Vol	Vcc reference, biased at Vcc -1.5v with 50 ohn	-1.7	-1.5	-1.3	V
Output Voltage High	Voh	Vcc reference, biased at Vcc -1.5v with 50 ohn	-1.1	-0.9	-0.7	V
Rise Time	Tr			1	3	ns
Fall Time	Tf			1	3	ns

78P2254 STM-1/STS-3 Transceiver

ELECTRICAL SPECIFICATIONS (continued)

DIGITAL TIMING CHARACTERISTICS

Transmit Interface

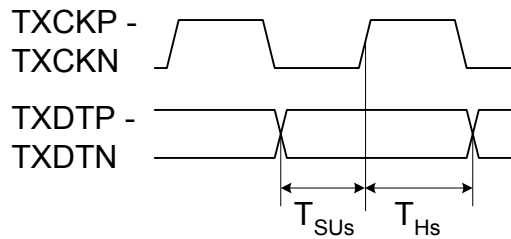

PARAMETER	SYMBOL	CONDITIONS	MIN	NOM	MAX	UNIT
Transmit Setup Time	T_{SUs}	Serial Mode	1.5			ns
Transmit Hold Time	T_{Hs}	Serial Mode	1.5			ns
TXCKP,N Duty Cycle			40		60	%

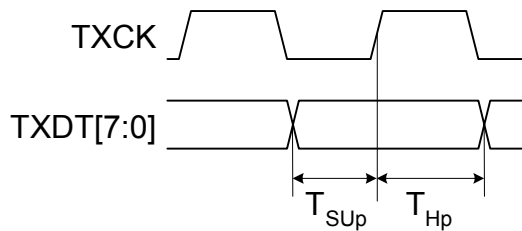

PARAMETER	SYMBOL	CONDITIONS	MIN	NOM	MAX	UNIT
Transmit Setup Time	T_{SUp}	Parallel Mode	3.5			ns
Transmit Hold Time	T_{Hp}	Parallel Mode	2.5			ns
TXCK Duty Cycle			40		60	%

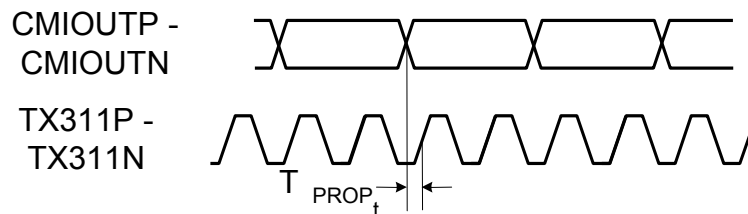

PARAMETER	SYMBOL	CONDITIONS	MIN	NOM	MAX	UNIT
TX311P,N Propagation Delay	T_{PROPt}		2.1	2.67	3.2	ns
Propagation Delay Variance					20	%

ELECTRICAL SPECIFICATIONS (continued)

DIGITAL TIMING CHARACTERISTICS

Receive Interface

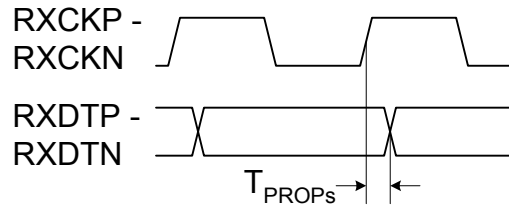

PARAMETER	SYMBOL	CONDITIONS	MIN	NOM	MAX	UNIT
Receive Propagation Delay	T_{PROPSs}	Serial Mode		2.4	3.0	ns
RXCKP,N Duty Cycle			40		60	%

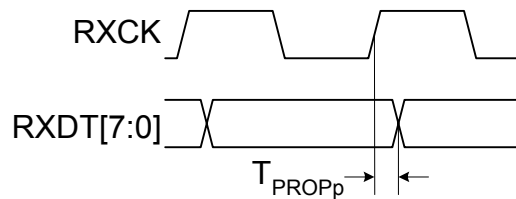

PARAMETER	SYMBOL	CONDITIONS	MIN	NOM	MAX	UNIT
Receive Propagation Delay	T_{PROPPp}	Parallel Mode		4.0	6.0	ns
RXCKP,N Duty Cycle			40		60	%

78P2254

STM-1/STS-3

Transceiver

ELECTRICAL SPECIFICATIONS (continued)

DIGITAL TIMING CHARACTERISTICS: Reference Clock Interface

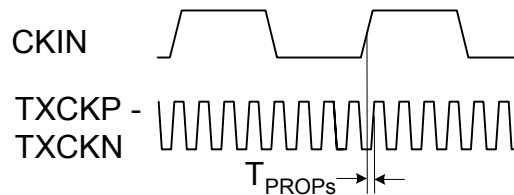

PARAMETER	SYMBOL	CONDITIONS	MIN	NOM	MAX	UNIT
CKIN to TXCKP/N Delay	T_{PROPS}	Serial Mode	3.1	4.6	5.6	ns

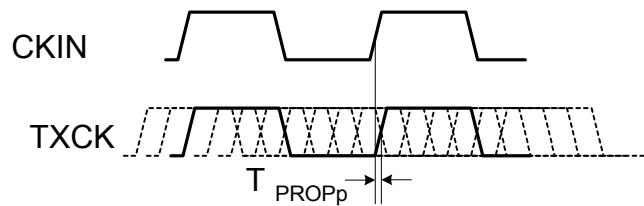

PARAMETER	SYMBOL	CONDITIONS	MIN	NOM	MAX	UNIT
CKIN to closes phase of TXCK Delay	T_{PROPP}	Parallel 8 bit Mode	1.6	3.7	5.7	ns

ELECTRICAL SPECIFICATIONS (continued)

TRANSMITTER OUTPUT JITTER

The transmit jitter specification ensures compliance with ITU-T G.825, G.958 and ANSI T1.105.03-1994 for STM-1 and STS-3 rates. The corner frequency of the transmit PLL is nominally 3.0 MHz.

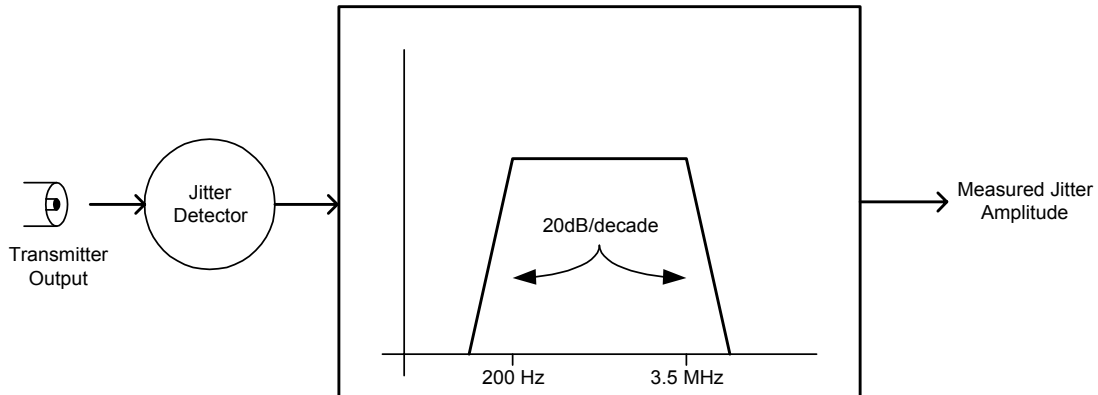

PARAMETER	CONDITION	MIN	NOM	MAX	UNIT
Transmitter Output Jitter	200 Hz to 3.5 MHz			0.075	UI

TRANSMITTER SPECIFICATIONS FOR CMI INTERFACE IN STS-3 (STM-1) MODE

Bit Rate: 155.52Mbit/s \pm 20ppm

Code: coded mark inversion (CMI)

The following specifications are met with the external components for STS-1 operation configured with a recommended 1:1 transformer. With the coaxial output port driving a 75 Ω load, the output pulses conform to the templates in Figure 2 and Figure 3.

PARAMETER	CONDITION	MIN	NOM	MAX	UNIT
Peak-to-peak Output Voltage	Template	0.9		1.1	V
Rise/ Fall Time	10-90%			2	ns
Transition Timing Tolerance	Negative Transitions	-0.1		0.1	ns
	Positive Transitions at Interval Boundaries	-0.5		0.5	ns
	Positive Transitions at mid-interval	-0.35		0.35	ns

TRANSMISSION PERFORMANCE

PARAMETER	CONDITION	MIN	NOM	MAX	UNIT
Return Loss	7MHz to 240MHz	15			dB

78P2254 STM-1/STS-3 Transceiver

ELECTRICAL SPECIFICATIONS (continued)

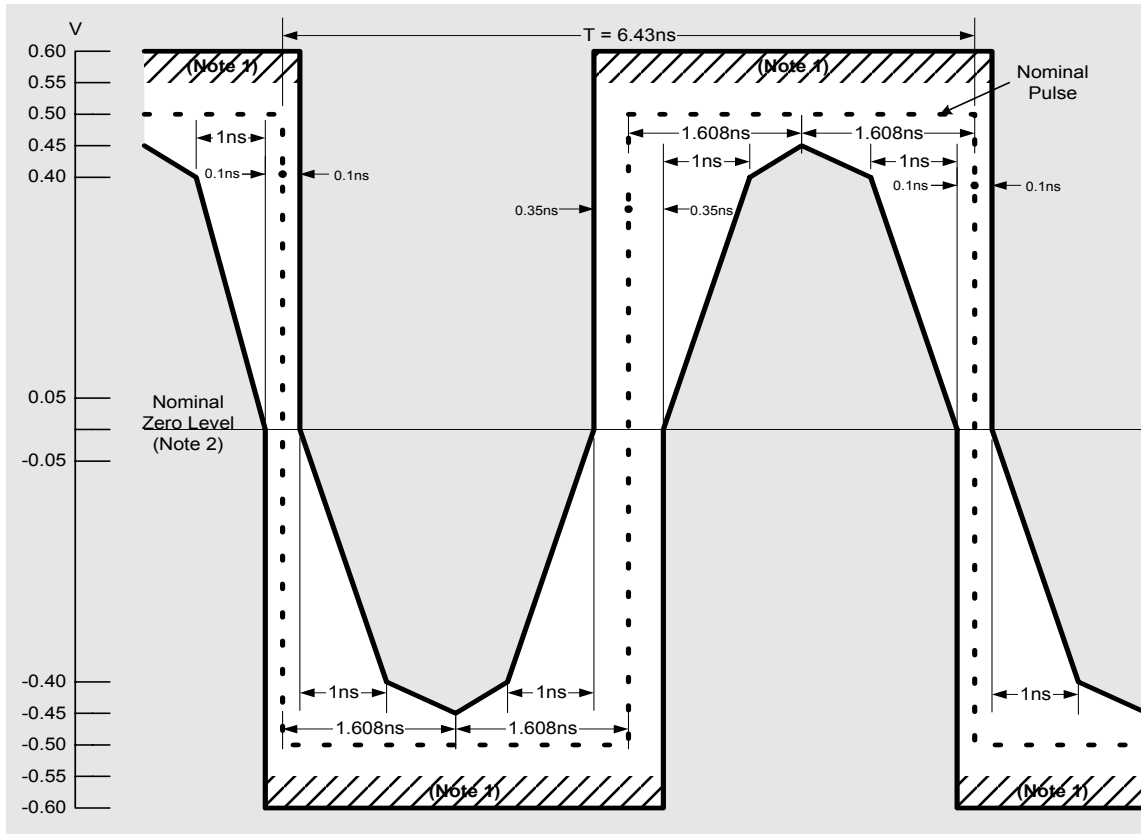

Note 1 – The maximum “steady state” amplitude should not exceed the 0.55V limit. Overshoots and other transients are permitted to fall into the shaded area bounded by the amplitude levels 0.55V and 0.6V, provided that they do not exceed the steady state level by more than 0.05V.

Note 2 – For all measurements using these masks, the signal should be AC coupled, using a capacitor of not less than 0.01 μF , to the input of the oscilloscope used for measurements. The nominal zero level for both masks should be aligned with the oscilloscope trace with no input signal. With the signal then applied, the vertical position of the trace can be adjusted with the objective of meeting the limits of the masks. Any such adjustment should be the same for both masks and should not exceed $\pm 0.05\text{V}$. This may be checked by removing the input signal again and verifying that the trace lies with $\pm 0.05\text{V}$ of the nominal zero level of the masks.

Note 3 – Each pulse in a coded pulse sequence should meet the limits of the relevant mask, irrespective of the state of the preceding or succeeding pulses, with both pulse masks fixed in the same relation to a common timing reference, i.e. with their nominal start and finish edges coincident. The masks allow for HF jitter caused by intersymbol interference in the output stage, but not for jitter present in the timing signal associated with the source of the interface signal. When using an oscilloscope technique to determine pulse compliance with the mask, it is important that successive traces of the pulses overlay in order to suppress the effects of low frequency jitter. This can be accomplished by several techniques [e.g. a) triggering the oscilloscope on the measured waveform or b) providing both the oscilloscope and the pulse output circuits with the same clock signal].

Note 4 – For the purpose of these masks, the rise time and decay time should be measured between -0.4V and 0.4V , and should not exceed 2ns.

Figure 2 – Mask of a Pulse corresponding to a binary Zero in STS-3 mode.

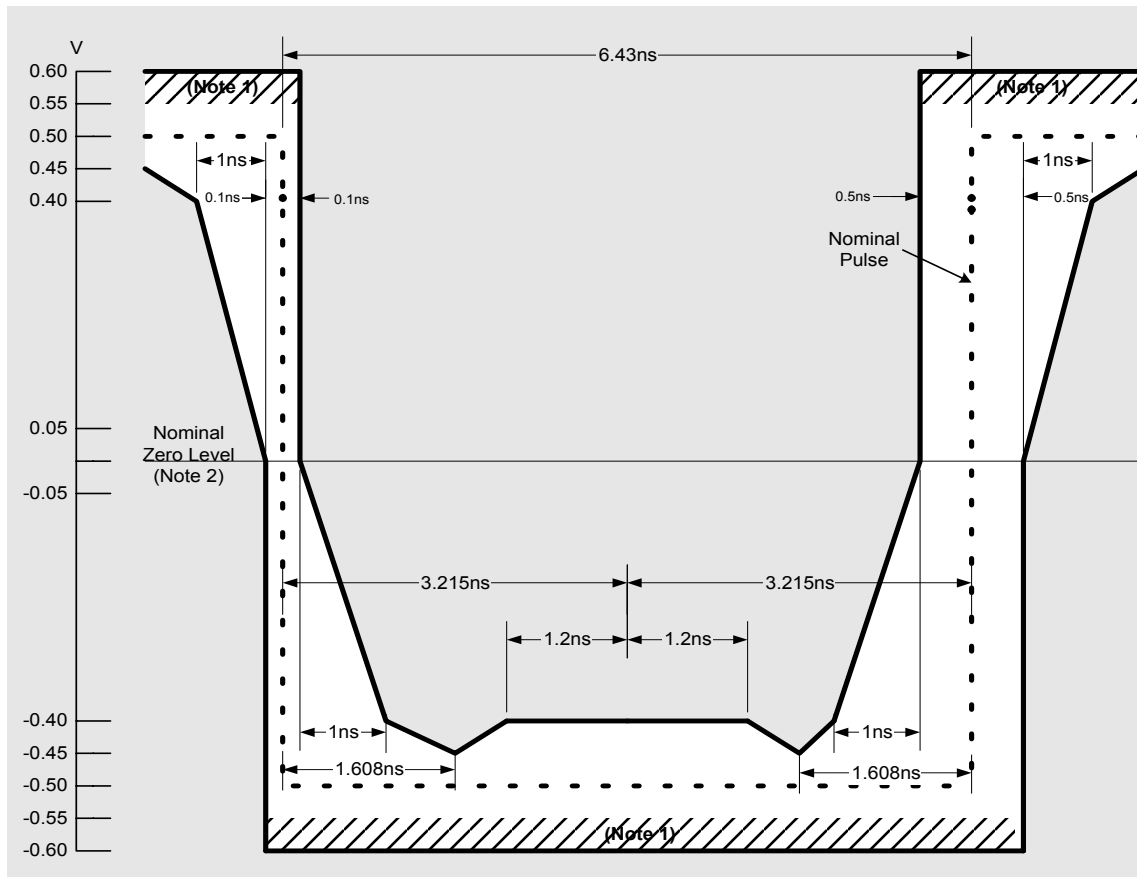

Note 1 – The maximum “steady state” amplitude should not exceed the 0.55V limit. Overshoots and other transients are permitted to fall into the shaded area bounded by the amplitude levels 0.55V and 0.6V, provided that they do not exceed the steady state level by more than 0.05V.

Note 2 – For all measurements using these masks, the signal should be AC coupled, using a capacitor of not less than 0.01 μF , to the input of the oscilloscope used for measurements. The nominal zero level for both masks should be aligned with the oscilloscope trace with no input signal. With the signal then applied, the vertical position of the trace can be adjusted with the objective of meeting the limits of the masks. Any such adjustment should be the same for both masks and should not exceed $\pm 0.05\text{V}$. This may be checked by removing the input signal again and verifying that the trace lies with $\pm 0.05\text{V}$ of the nominal zero level of the masks.

Note 3 – Each pulse in a coded pulse sequence should meet the limits of the relevant mask, irrespective of the state of the preceding or succeeding pulses, with both pulse masks fixed in the same relation to a common timing reference, i.e. with their nominal start and finish edges coincident. The masks allow for HF jitter caused by intersymbol interference in the output stage, but not for jitter present in the timing signal associated with the source of the interface signal. When using an oscilloscope technique to determine pulse compliance with the mask, it is important that successive traces of the pulses overlay in order to suppress the effects of low frequency jitter. This can be accomplished by several techniques [e.g. a) triggering the oscilloscope on the measured waveform or b) providing both the oscilloscope and the pulse output circuits with the same clock signal].

Note 4 – For the purpose of these masks, the rise time and decay time should be measured between -0.4V and 0.4V , and should not exceed 2ns.

Note 5 –The inverse pulse will have the same characteristics, noting that the timing tolerance at the level of the negative and positive transitions are $\pm 0.1\text{ns}$ and $\pm 0.5\text{ns}$ respectively.

Figure 3 – Mask of a Pulse corresponding to a binary One in STS-3 mode

78P2254 STM-1/STS-3 Transceiver

ELECTRICAL SPECIFICATIONS (continued)

RECEIVER SPECIFICATIONS

The following specifications are met with the external components.

PARAMETER	CONDITION	MIN	NOM	MAX	UNIT
LOS Threshold		0.05	0.1	0.2	V

RECEPTION PERFORMANCE

Return Loss	7MHz to 240MHz	15			dB
-------------	----------------	----	--	--	----

RECEIVER JITTER TOLERANCE

STS-3 jitter tolerance specifications are in ANSI T1.105.05-1994 and Telcordia TR-NWT-000253, Issue 2, Dec. 1991. STM-1 specifications are in ITU-T G.825. They are identical except that STM-1 specifies both jitter and wander. The STM-1 specification is the tightest and covers the largest frequency range.

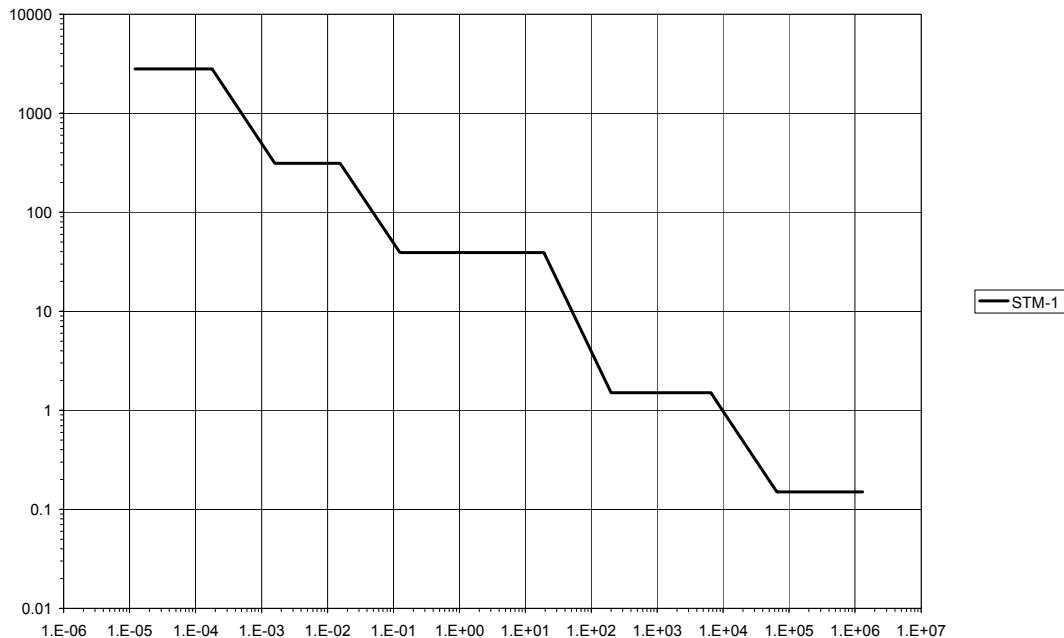

PARAMETER	CONDITION	MIN	NOM	MAX	UNIT
Receiver Jitter Tolerance	12µHz to 178µHz	2800			UI
	1.6mHz to 15.6mHz	311			
	125mHz to 19.3 Hz	39			
	500Hz to 6.5kHz	1.5			
Note 1: Not tested in production	65kHz to 3.5MHz	0.15			

ELECTRICAL SPECIFICATIONS (continued)

RECEIVER JITTER TRANSFER FUNCTION

The receiver clock recovery loop filter characteristics such that the receiver has the following transfer function. The corner frequency of the PLL is approximately 100 kHz.



PARAMETER	CONDITION	MIN	NOM	MAX	UNIT
Receiver Jitter transfer function	below 100 kHz			0.1	dB
Jitter transfer function roll-off			20		dB per decade
Note 1: Not tested in production					

78P2254 STM-1/STS-3 Transceiver

APPLICATION INFORMATION

EXTERNAL COMPONENTS:

COMPONENT	PIN(S)	VALUE	UNITS	TOLERANCE
Reference Resistor	RFO	31.6	k Ω	1%
Filter Capacitor	LF1	470	nF	5%

TRANSFORMER SPECIFICATIONS:

COMPONENT	VALUE	UNITS	TOLERANCE
Turns Ratio		1:1	3%

Suggested Manufacturer: Halo, MiniCircuits

CRYSTAL SPECIFICATIONS:

COMPONENT	VALUE	UNITS	TOLERANCE
Center Frequency	19.44	MHz	+/- 20ppm
Load Capacitor – XTAL1 to ground; XTAL2 to ground <ul style="list-style-type: none"> ➤ Please check datasheet of crystal manufacturer for optimal load capacitor values. 	27	pF	

PECL INTERFACE COMPONENTS:

COMPONENT	VALUE	UNITS	TOLERANCE	
Output Bias Resistor, R_{BIAS}	$V_{CC} = 5v$ $V_{CC} = 3.3V$	250 140	Ω Ω	5% 5%
Termination Resistor, R_{TERM}	100	Ω	5%	

When the PECL signals travel one inch or less, lower power operation can be achieved by increasing R_{BIAS} and eliminating R_{TERM} .



FIGURE 4. PECL INTERFACE

MECHANICAL SPECIFICATIONS

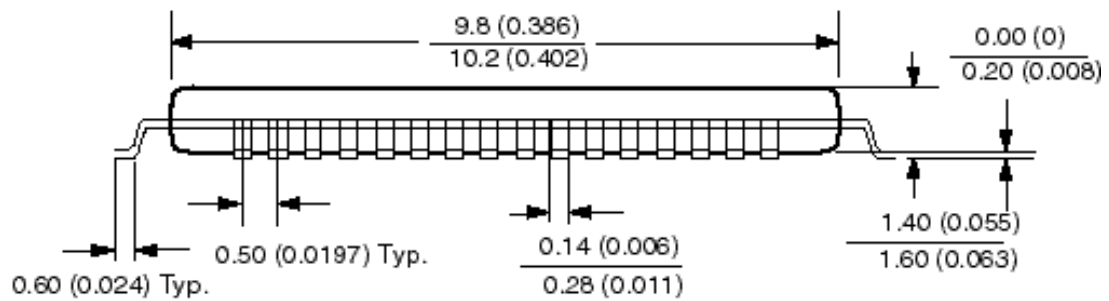
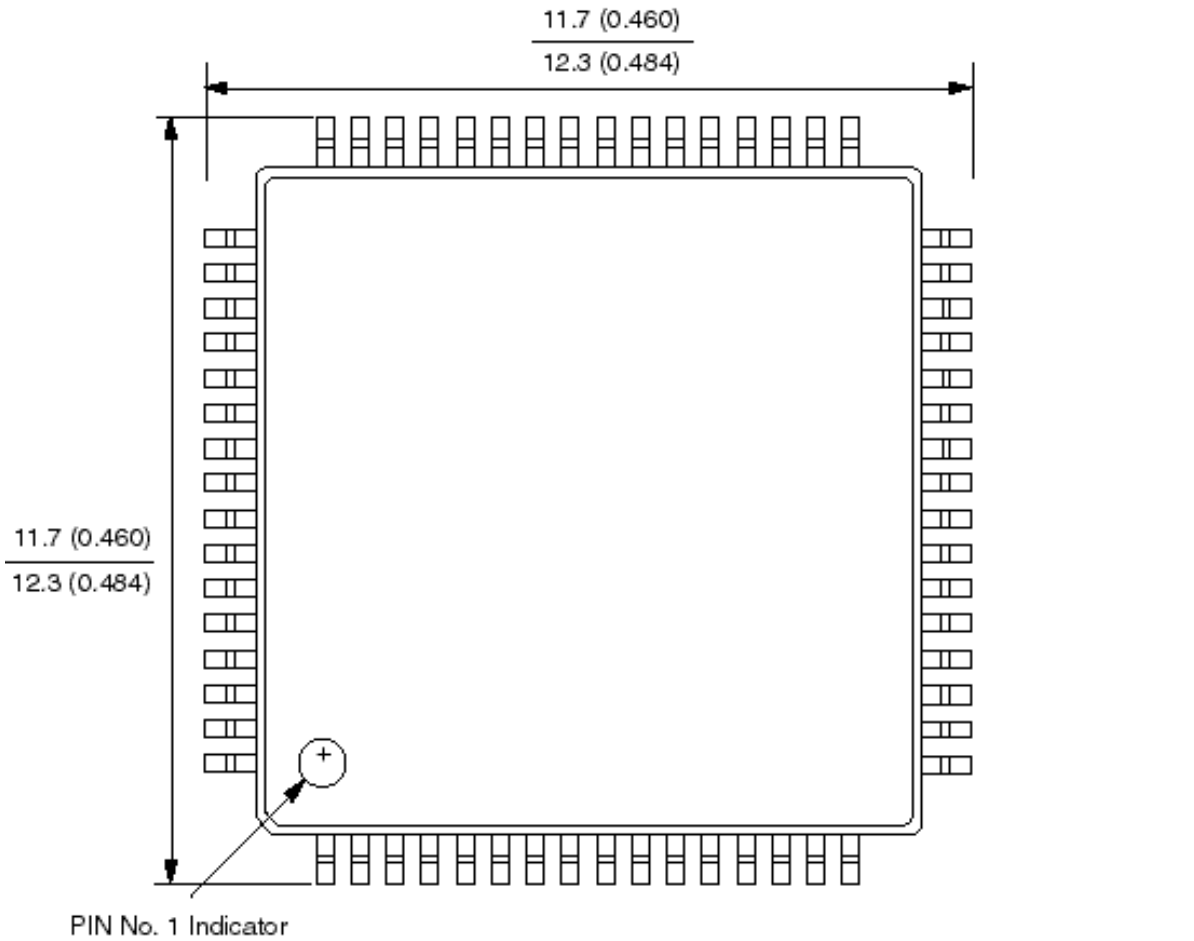

64-TQFP (JEDEC LQFP)
Mechanical Specification

78P2254 STM-1/STS-3 Transceiver

PACKAGE PIN DESIGNATIONS (Top View)

CAUTION: Use handling procedures necessary for a static sensitive component.

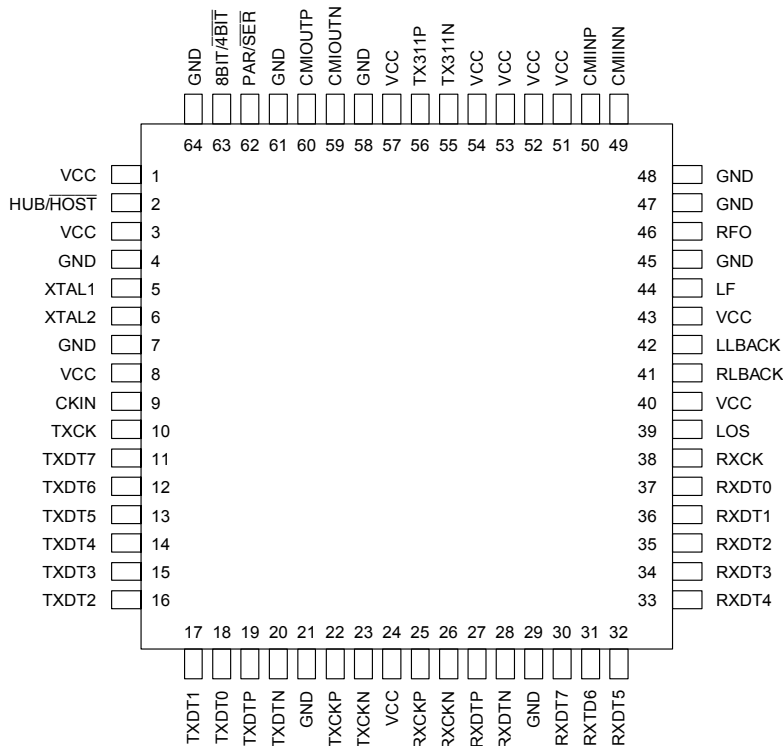

**64-Pin TQFP (JEDEC LQFP)
78P2254-IGT**

ORDERING INFORMATION

PART DESCRIPTION	ORDER NUMBER	PACKAGING MARK
78P2254 64- Pin Thin Quad Flatpack	78P2254-IGT	78P2254-IGT

Preliminary Data Sheet: This Preliminary Data Sheet describes a product not completely released to production. The specifications are based on preliminary evaluations and may not be accurate. Samples of the described product are available and limited quantities can be purchased. TDK Semiconductor Corporation should be consulted for the most current up-to-date information about the product.

This product is sold subject to the terms and conditions of sale supplied at the time of order acknowledgment, including those pertaining to warranty, patent infringement and limitation of liability. TDK Semiconductor Corporation (TSC) reserves the right to make changes in specifications at any time without notice. Accordingly, the reader is cautioned to verify that a data sheet is current before placing orders. TSC assumes no liability for applications assistance.

TDK Semiconductor Corp., 2642 Michelle Dr., Tustin, CA 92780
TEL (714) 508-8800, FAX (714) 508-8877, <http://www.tdksemiconductor.com>