

6 AMP ULTRAFAST RECOVERY DIODES

FEATURES

- Low switching noise
- Low forward voltage drop
- Low thermal resistance
- High switching capability
- High surge capability
- High reliability

RoHS COMPLIANT

MECHANICAL DATA

- Case: Molded epoxy (U/L Flammability Rating 94V-0)
- Terminals: Plated axial leads
- Solderability: Per MIL-STD 202 Method 208 guaranteed
- Polarity: Color band denotes cathode
- Mounting Position: Any
- Weight: 0.07 Ounces (2.1 Grams)

MECHANICAL SPECIFICATION

ACTUAL SIZE OF UFR600 PACKAGE



SERIES UFR600 - UFR608

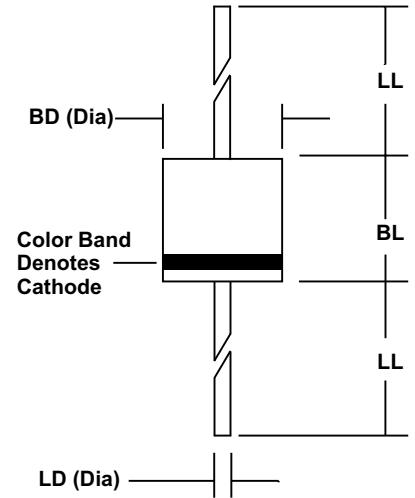

Sym	Minimum		Maximum	
	In	mm	In	mm
BL	0.340	8.6	0.360	9.1
BD	0.340	8.6	0.360	9.1
LL	1.00	25.4		
LD	0.048	1.2	0.052	1.3

MAXIMUM RATINGS & ELECTRICAL CHARACTERISTICS

Ratings at 25 °C ambient temperature unless otherwise specified.
 Single phase, half wave, 60Hz, resistive or inductive load.
 For capacitive loads, derate current by 20%.

PARAMETER (TEST CONDITIONS)	SYMBOL	RATINGS								UNITS
		UFR 600	UFR 601	UFR 602	UFR 603	UFR 604	UFR 606	UFR 608		
Series Number										
Maximum DC Blocking Voltage	V _{RM}	50	100	200	300	400	600	800		VOLTS
Maximum RMS Voltage	V _{RMS}	35	70	140	210	280	420	560		
Maximum Peak Recurrent Reverse Voltage	V _R RM	50	100	200	300	400	600	800		
Average Forward Rectified Current @ T _A = 55 °C	I _O	6								AMPS
Peak Forward Surge Current (8.3mS single half sine wave superimposed on rated load)	I _{FSM}	300								
Maximum Forward Voltage at 6 Amps DC	V _{FM}	1.25						1.4		VOLTS
Maximum Average DC Reverse Current @ T _C = 25 °C At Rated DC Blocking Voltage @ T _C = 100 °C	I _{RM}	10 200								μA
Typical Thermal Resistance, Junction to Case	R _{θJC}	10								°C/W
Typical Junction Capacitance (Note 1)	C _J	100								pF
Maximum Reverse Recovery Time (I _F =0.5A, I _R =1A, I _{RR} =0.25A)	T _{RR}	60			75			90		nSec
Junction Operating and Storage Temperature Range	T _J , T _{STG}	-65 to +150								°C

NOTES: (1) Measured at 1 MHz and an applied reverse voltage of 4 volts.

01.00 / sss08

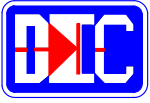

6 AMP ULTRAFAST RECOVERY DIODES

RATING & CHARACTERISTIC CURVES FOR SERIES UFR600 - UFR608

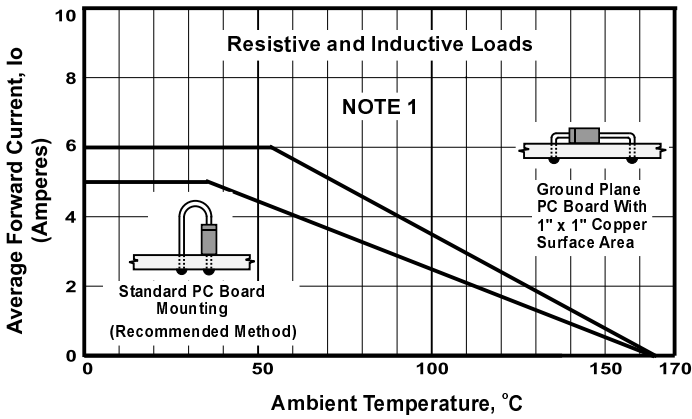

FIGURE 1. FORWARD CURRENT DERATING CURVE

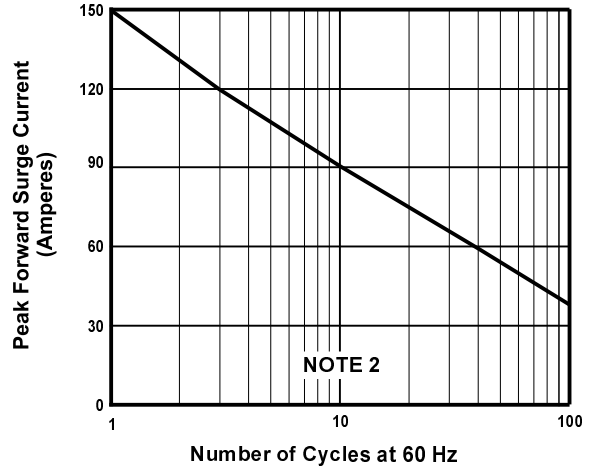

FIGURE 2. MAXIMUM NON-REPETITIVE SURGE CURRENT

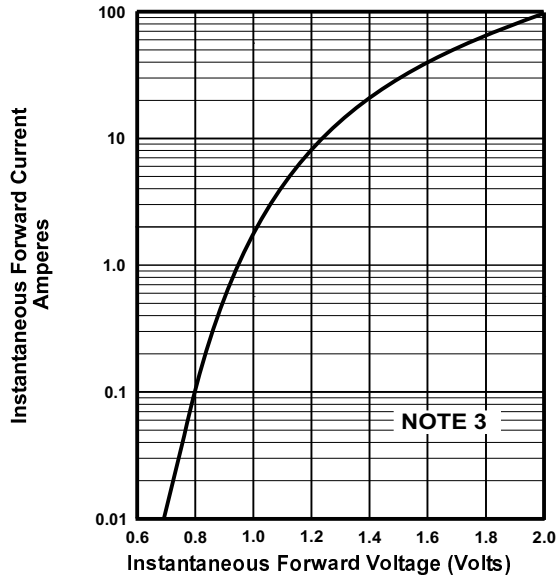

FIGURE 3. TYPICAL FORWARD CHARACTERISTICS

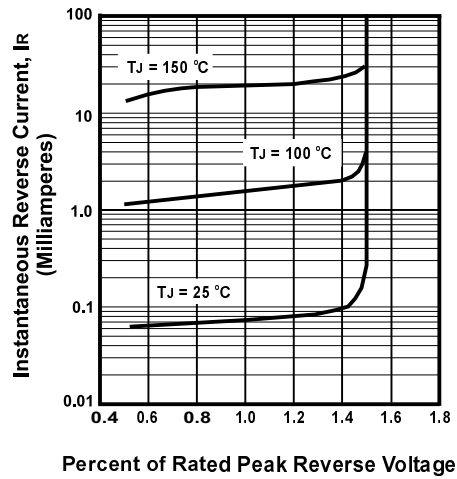

FIGURE 4. TYPICAL REVERSE CHARACTERISTICS

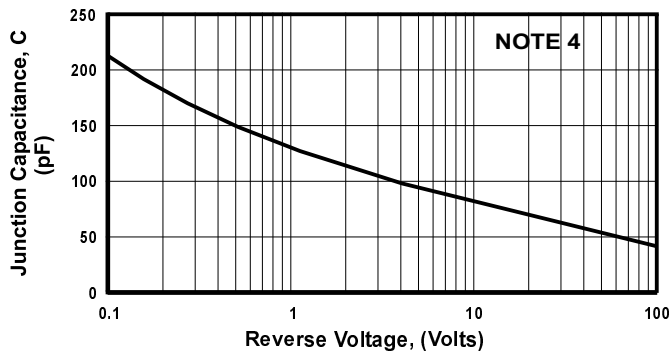

FIGURE 5. TYPICAL JUNCTION CAPACITANCE

NOTES

- (1) Single Phase, Half Wave, 60 Hz
- (2) JEDEC Method, 8.3 mSec. Single Half Sine Wave;
- (3) $T_J = 25^\circ\text{C}$, Pulse Width = 300 μSec , 2.0% Duty Cycle
- (4) $T_J = 25^\circ\text{C}$, $f = 1\text{ MHz}$, $V_{SIG} = 50\text{ mV P-P}$