

N-Channel 75-V (D-S) MOSFET with Sense Terminal

PRODUCT SUMMARY

$V_{(BR)DSS}$ (V)	$r_{DS(on)}$ (Ω)	I_D (A)
75	0.007 @ $V_{GS} = 10$ V	60 ^a

FEATURES

- TrenchFET[®] Power MOSFET Plus Current Sense
- New Low Thermal Resistance Package

APPLICATIONS

- Automotive
- Industrial

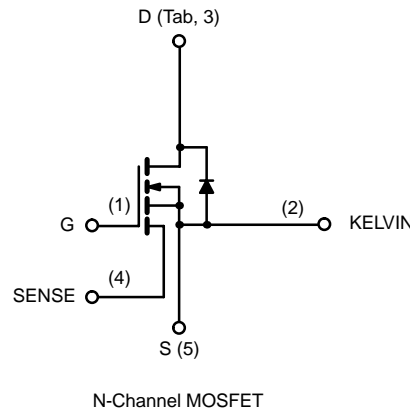
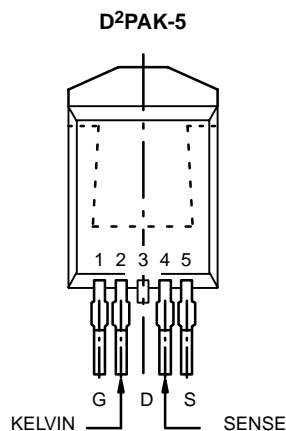
ABSOLUTE MAXIMUM RATINGS ($T_C = 25^\circ\text{C}$ UNLESS OTHERWISE NOTED)

Parameter		Symbol	Limit	Unit
Drain-Source Voltage		V_{DS}	75	V
Gate-Source Voltage		V_{GS}	± 20	
Continuous Drain Current ($T_J = 175^\circ\text{C}$) ^d	$T_C = 25^\circ\text{C}$	I_D	60 ^a	A
	$T_C = 100^\circ\text{C}$		60 ^a	
Pulsed Drain Current		I_{DM}	240	
Continuous Diode Current (Diode Conduction) ^d		I_S	60 ^a	
Avalanche Current		I_{AR}	60 ^a	
Repetitive Avalanche Energy ^b	L = 0.1 mH	E_{AR}	180	mJ
	$T_C = 25^\circ\text{C}$		300 ^c	
Maximum Power Dissipation ^a	$T_C = 25^\circ\text{C}$	P_D	3.75 ^d	W
	$T_A = 25^\circ\text{C}$			
Operating Junction and Storage Temperature Range		T_J, T_{stg}	-55 to 175	$^\circ\text{C}$

THERMAL RESISTANCE RATINGS

Parameter		Symbol	Limit	Unit
Junction-to-Ambient ^d	PCB Mount ^d	R_{thJA}	40	$^\circ\text{C/W}$
Junction-to-Case		R_{thJC}	0.5	

Notes

- Package limited.
- Duty cycle $\leq 1\%$.
- See SOA curve for voltage derating.
- When mounted on 1" square PCB (FR-4 material).

MOSFET SPECIFICATIONS ($T_J = 25^\circ\text{C}$ UNLESS OTHERWISE NOTED)						
Parameter	Symbol	Test Condition	Min	Typ	Max	Unit
Static						
Drain-Source Breakdown Voltage	$V_{(BR)DSS}$	$V_{GS} = 0\text{ V}, I_D = 250\ \mu\text{A}$	75			V
Gate Threshold Voltage	$V_{GS(th)}$	$V_{DS} = V_{GS}, I_{DS} = 250\ \mu\text{A}$	2		4	
Gate-Body Leakage	I_{GSS}	$V_{DS} = 0\text{ V}, V_{GS} = \pm 20\text{ V}$			± 100	nA
Zero Gate Voltage Drain Current	I_{DSS}	$V_{DS} = 60\text{ V}, V_{GS} = 0\text{ V}$			1	μA
		$V_{DS} = 60\text{ V}, V_{GS} = 0\text{ V}, T_J = 125^\circ\text{C}$			50	
		$V_{DS} = 60\text{ V}, V_{GS} = 0\text{ V}, T_J = 175^\circ\text{C}$			500	
On-State Drain Current ^a	$I_{D(on)}$	$V_{DS} = 5\text{ V}, V_{GS} = 10\text{ V}$	120			A
Drain-Source On-State Resistance ^a	$r_{DS(on)}$	$V_{GS} = 10\text{ V}, I_D = 25\text{ A}$		0.0054	0.007	Ω
		$V_{GS} = 10\text{ V}, I_D = 25\text{ A}, T_J = 125^\circ\text{C}$			0.010	
		$V_{GS} = 10\text{ V}, I_D = 25\text{ A}, T_J = 175^\circ\text{C}$			0.013	
Forward Transconductance ^a	g_{fs}	$V_{DS} = 15\text{ V}, I_D = 20\text{ A}$		100		S
Dynamic^b						
Input Capacitance	C_{iss}	$V_{GS} = 0\text{ V}, V_{DS} = 25\text{ V}, f = 1\text{ MHz}$		6500		pF
Output Capacitance	C_{oss}			920		
Reverse Transfer Capacitance	C_{rss}			400		
Total Gate Charge ^c	Q_g	$V_{DS} = 35\text{ V}, V_{GS} = 10\text{ V}, I_D = 60\text{ A}$		110	150	nC
Gate-Source Charge ^c	Q_{gs}			30		
Gate-Drain Charge ^c	Q_{gd}			30		
Turn-On Delay Time ^c	$t_{d(on)}$	$V_{DD} = 35\text{ V}, R_L = 0.6\ \Omega$ $I_D = 60\text{ A}, V_{GEN} = 10\text{ V}, R_G = 2.5\ \Omega$		15	20	ns
Rise Time ^c	t_r			130	200	
Turn-Off Delay Time ^c	$t_{d(off)}$			75	115	
Fall Time ^c	t_f			120	180	
Source-Drain Diode Ratings and Characteristics ($T_C = 25^\circ\text{C}$)^b						
Continuous Current	I_S				60	A
Pulsed Current	I_{SM}				240	
Forward Voltage ^a	V_{SD}	$I_F = 60\text{ A}, V_{GS} = 0\text{ V}$		1.0	1.5	V
Reverse Recovery Time	t_{rr}	$I_F = 60\text{ A}, di/dt = 100\text{ A}/\mu\text{s}$		75	115	ns
Peak Reverse Recovery Current	$I_{RM(REC)}$			3.5	5	A
Reverse Recovery Charge	Q_{rr}			0.13	0.29	μC
Current Sense Characteristics						
Current Sensing Ratio	r	$I_D = 3.5\text{ A}, V_{GSS} = 10\text{ V}, R_{SENSE} = 2.0\ \Omega$	2270	2370	2470	
Mirror Active Resistance	$r_{m(on)}$	$V_{GS} = 10\text{ V}, I_D = 10\text{ mA}$		10		Ω

Notes:

- Pulse test; pulse width $\leq 300\ \mu\text{s}$, duty cycle $\leq 2\%$.
- Guaranteed by design, not subject to production testing.
- Independent of operating temperature.



TYPICAL CHARACTERISTICS (25°C UNLESS NOTED)

Output Characteristics

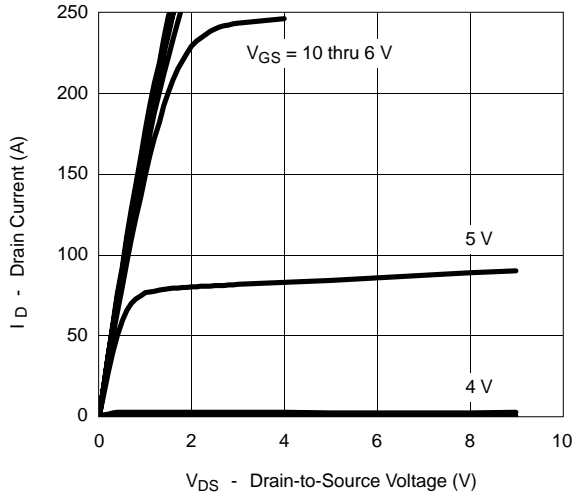

Transfer Characteristics

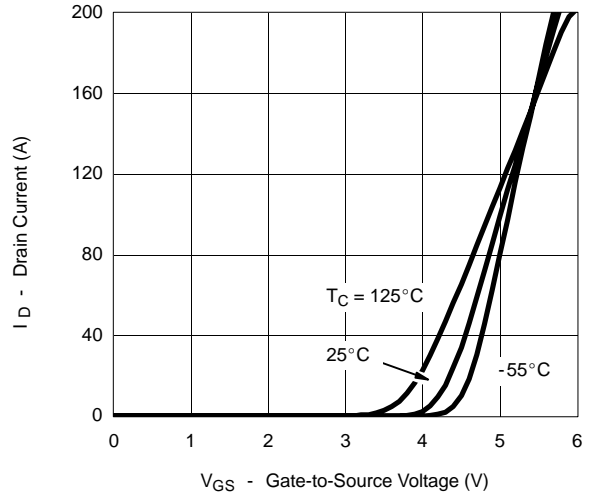

Transconductance

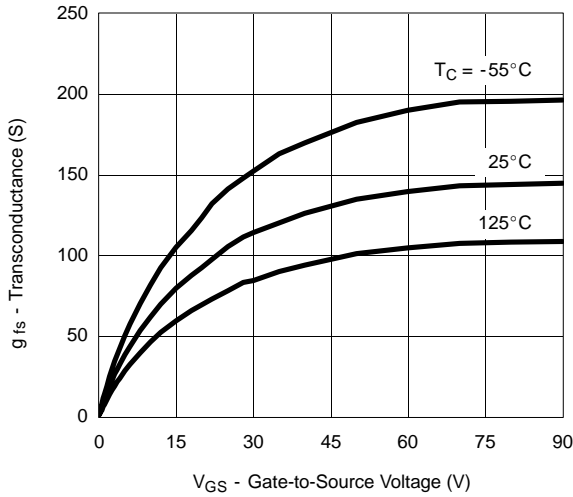

On-Resistance vs. Drain Current

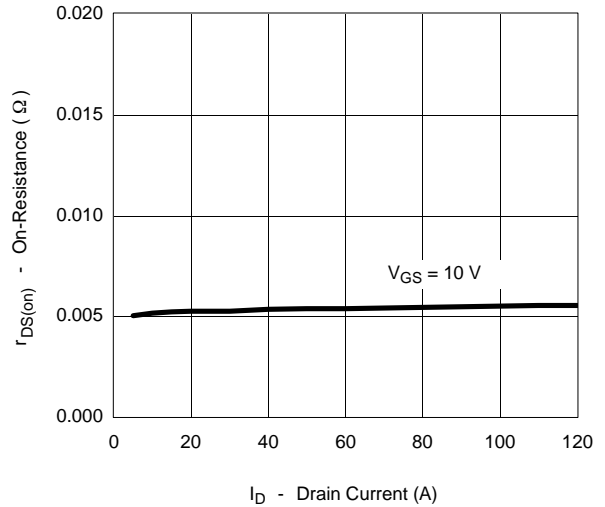

Capacitance

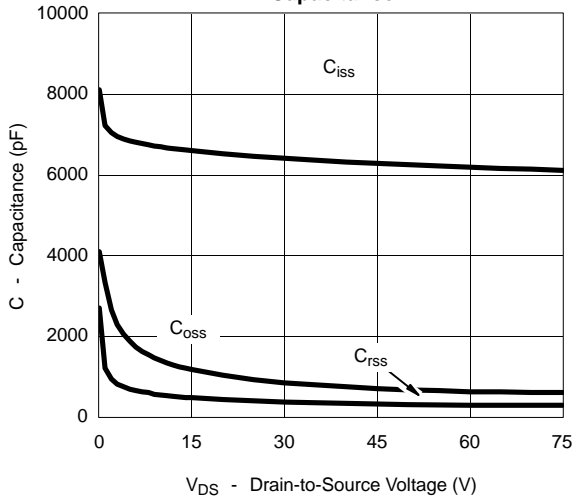

Gate Charge

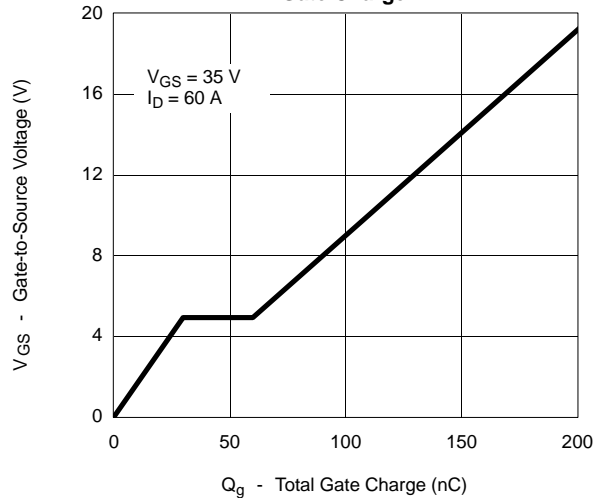

TYPICAL CHARACTERISTICS (25 °C UNLESS NOTED)

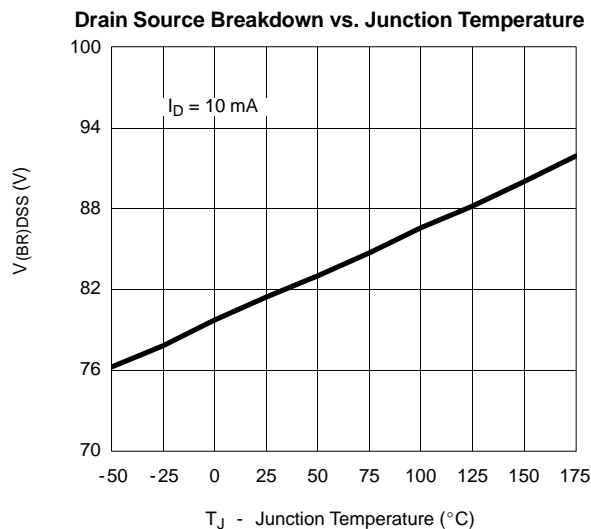
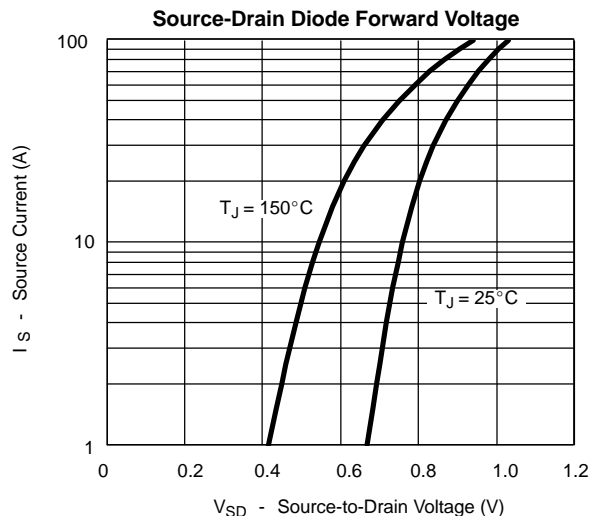
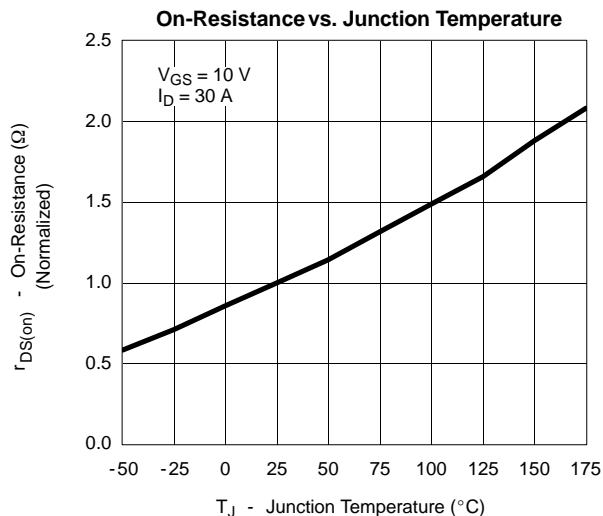

THERMAL RATINGS

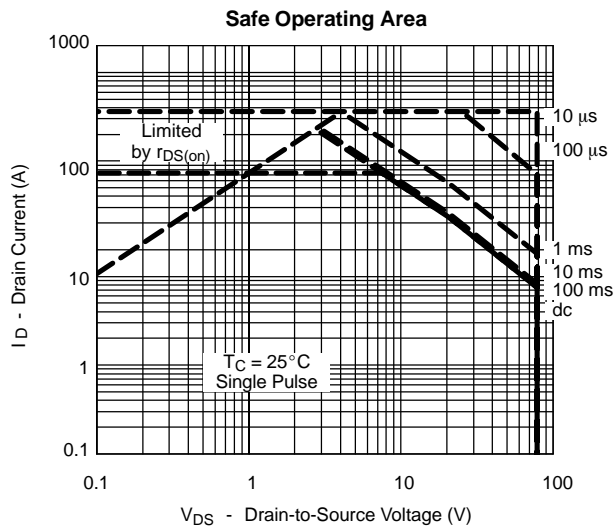
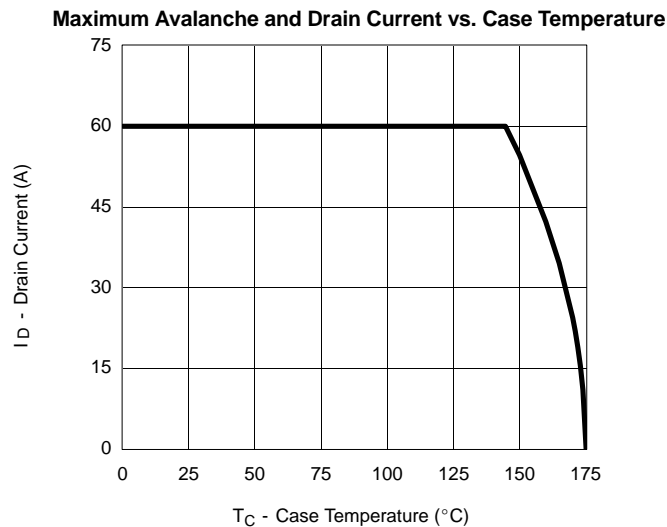

THERMAL RATINGS

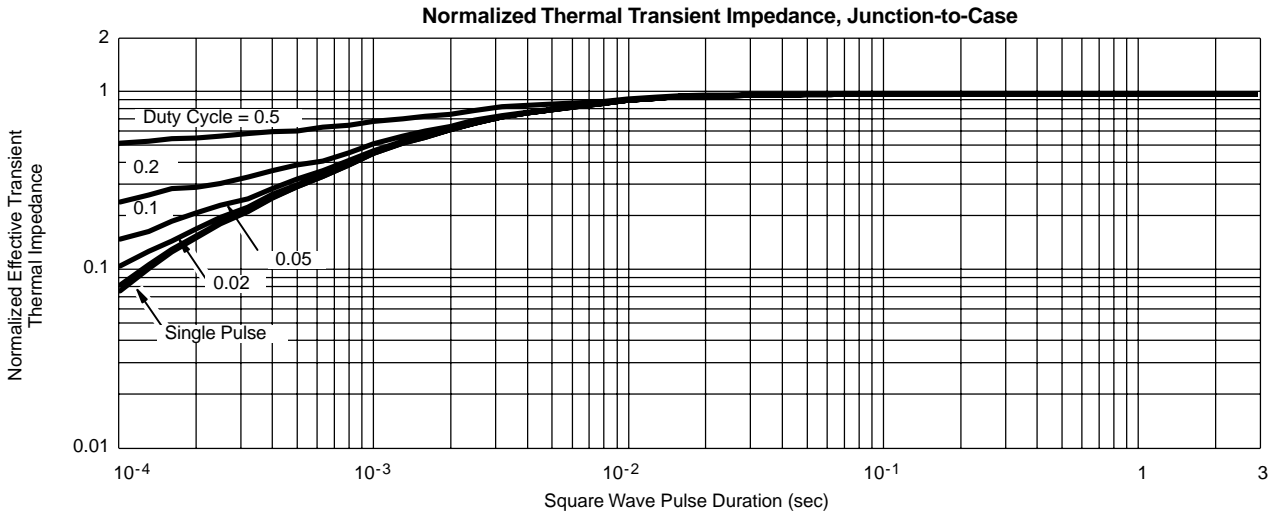

TYPICAL CHARACTERISTICS (25°C UNLESS NOTED)

SENSE DIE

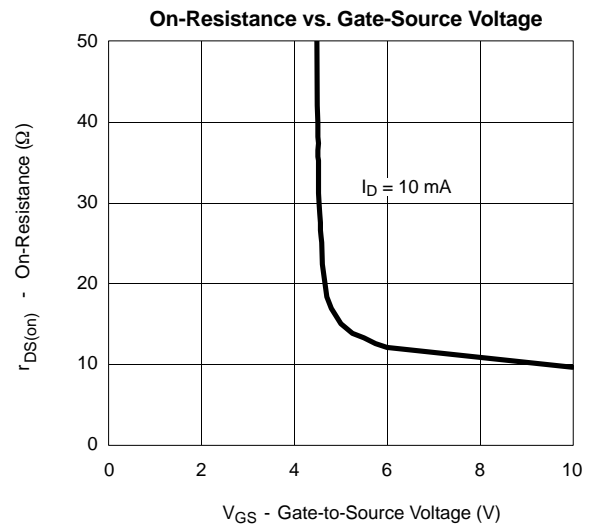
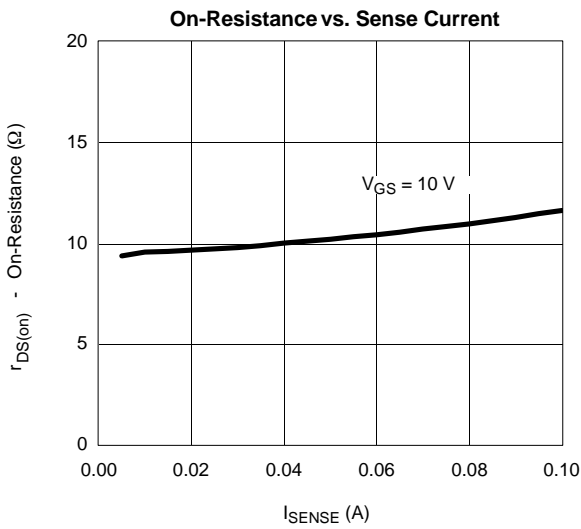

Current Ratio (I_{MAIN}/I_S) vs. Gate-Source Voltage (Figure 1)

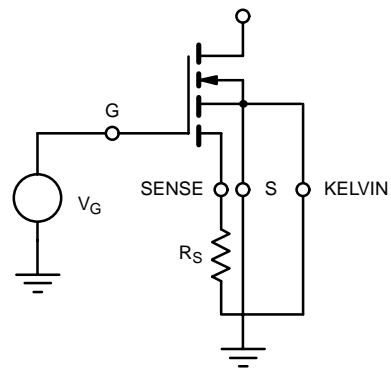
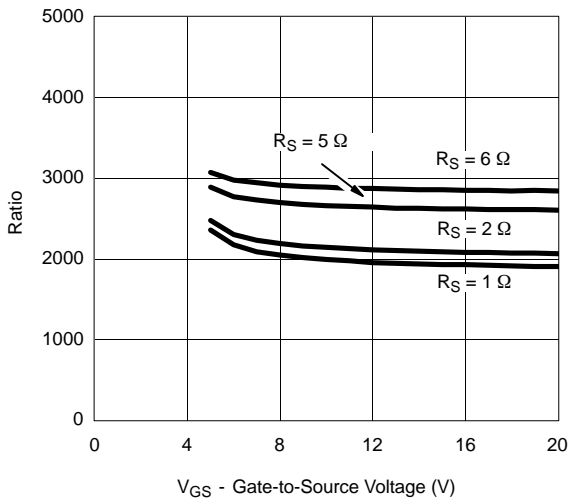

Figure 1