

# Am9111 Family

256 x 4 Static RAM

Am9111 Family

## DISTINCTIVE CHARACTERISTICS

- Low operating power dissipation  
125 mW typ.; 290 mW maximum — standard power  
100 mW typ.; 175 mW maximum — low power
- DC standby mode reduces power up to 84%
- High noise immunity — full 400 mV
- Uniform switching characteristics — access times insensitive to supply variations, addressing patterns and data patterns
- Output disable control
- Zero address setup and hold times for simplified timing

## GENERAL DESCRIPTION

The Am9111/Am91L11 series of devices are high-performance, low-power, 1024-bit, Static, Read/Write Random Access Memories. They offer a wide range of access times including versions as fast as 200 ns. Each memory is implemented as 256 words by 4 bits per word. This organization permits efficient design of small memory systems and allows finer resolution of incremental memory depth. The input data and output data signals are bussed together to share common I/O pins. This feature not only decreases the package size, but also helps eliminate external logic in bus-oriented memory systems.

These memories may be operated in a DC standby mode for reductions of as much as 84% of the normal power dissipation. Data can be retained with a power supply as

low as 1.5 volts. The low power Am91L11 series offer reduced power dissipation during normal operating conditions and even lower dissipation in the standby mode.

The Chip Enable input control signals act as high order address lines and they control the write amplifier and the output buffers. The Output Disable signal provides independent control over the output state of enabled chips.

These devices are fully static and no refresh operations, sense amplifiers or clocks are required. Input and output signal levels are identical to TTL specifications, providing simplified interfacing and high noise immunity. The outputs will drive two full TTL loads for increased fan-out and better bus interfacing capability.

## BLOCK DIAGRAM

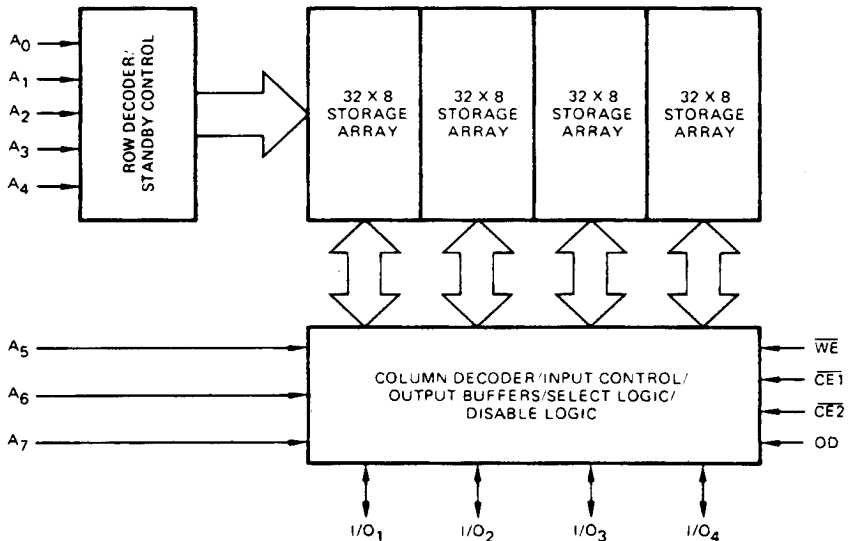

BD000220

Publication # 03256 Rev. D Amendment /0  
Issue Date: May 1986

## CONNECTION DIAGRAM Top View

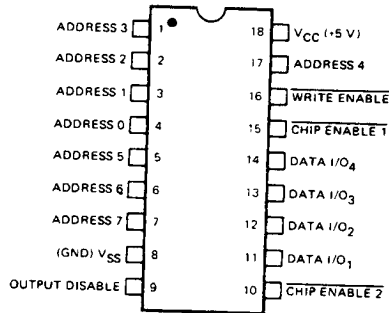

CD000320

## METALLIZATION AND PAD LAYOUT

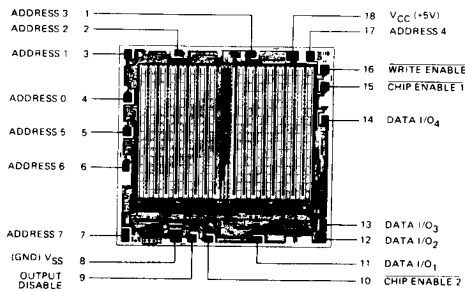

Die Size: 0.132" x 0.131"

4

## ORDERING INFORMATION (Cont'd.)

### Standard Products

AMD standard products are available in several packages and operating ranges. The order number (Valid Combination) is formed by a combination of:

- A. Device Number**
- B. Speed Option** (if applicable)
- C. Package Type**
- D. Temperature Range**
- E. Optional Processing**

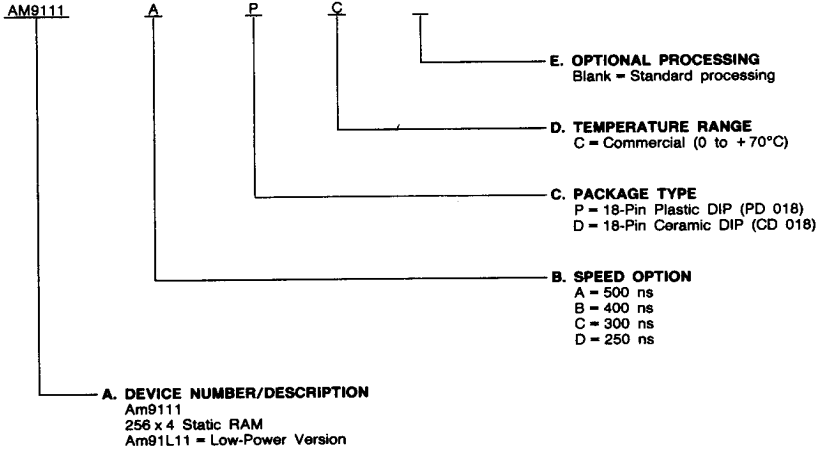

Valid Combinations	
AM9111A	PC, DC
AM9111B	
AM9111C	
AM9111D	
AM91L11A	
AM91L11B	
AM91L11C	

#### Valid Combinations

Valid Combinations list configurations planned to be supported in volume for this device. Consult the local AMD sales office to confirm availability of specific valid combinations, to check on newly released combinations, and to obtain additional data on AMD's standard military grade products.

# ORDERING INFORMATION

## APL Products

AMD products for Aerospace and Defense applications are available in several packages and operating ranges. APL (Approved Products List) products are fully compliant with MIL-STD-883C requirements. CPL (Controlled Products List) products are processed in accordance with MIL-STD-883C, but are inherently non-compliant because of package, solderability, or surface treatment exceptions to those specifications. The order number (Valid Combination) for APL products is formed by a combination of:

- A. Device Number**
- B. Speed Option** (if applicable)
- C. Device Class**
- D. Package Type**
- E. Lead Finish**

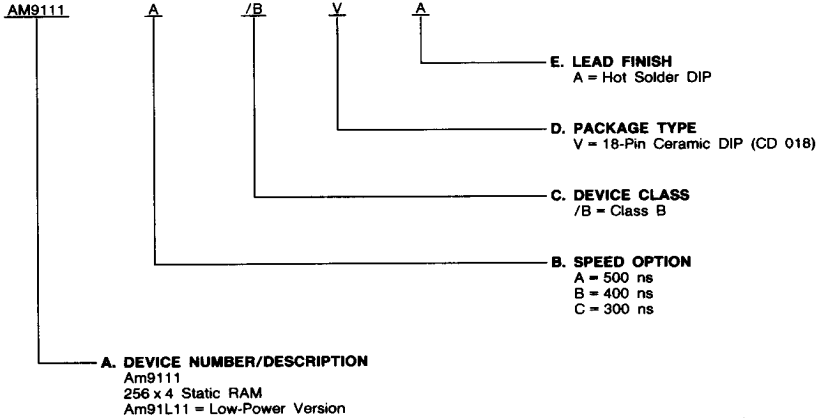

Valid Combinations	
AM9111A	/BVA
AM9111B	
AM9111C	
AM91L11A	
AM91L11B	
AM91L11C	

### Valid Combinations

Valid Combinations list configurations planned to be supported in volume for this device. Consult the local AMD sales office to confirm availability of specific valid combinations or to check for newly released valid combinations.

## ORDERING INFORMATION

### Commodity Products

AMD commodity products are available in several packages and operating ranges. The order number (Valid Combination) is formed by a combination of:

- A. Temperature Range**
- B. Package Type**
- C. Device Number**
- D. Speed Option**

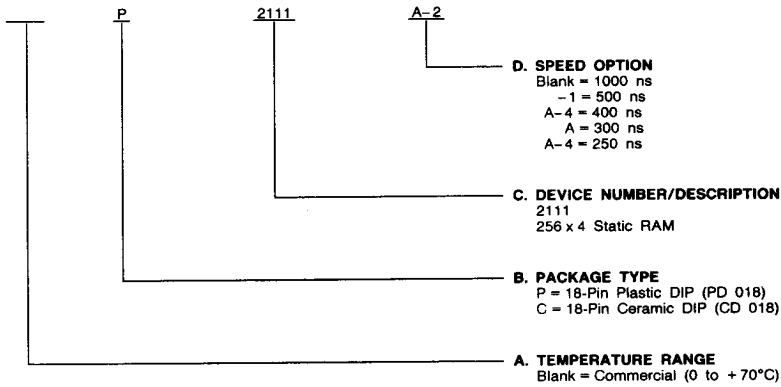

#### Valid Combinations

Valid Combinations list configurations planned to be supported in volume for this device. Consult the local AMD sales office to confirm availability of specific valid combinations, to check on newly released valid combinations, and to obtain additional data on AMD's standard military grade products.

Valid Combinations		
P, C	2111	-1, A-4, A, A-2

## PIN DESCRIPTION

### **A<sub>0</sub> - A<sub>7</sub> Addresses (Input)**

The 8-bit field presented at the address inputs selects one of the 256 memory locations to be read from — or written into — via the Data Input/Output lines.

### **I/O<sub>1</sub> - I/O<sub>4</sub> Data Input/Output Lines (Input/Output)**

If  $\overline{WE}$  is LOW, the data represented on the Data I/O lines can be written into the selected memory location. If  $\overline{WE}$  is HIGH, the Data I/O lines represent the data read from the selected memory location.

### **$\overline{CE1}$ , $\overline{CE2}$ Chip Enable Signals (Input)**

Read and Write cycles can be executed only when both  $\overline{CE1}$  and  $\overline{CE2}$  are LOW.

### **$\overline{WE}$ Write Enable (Input, Active LOW)**

Data is written into the memory if  $\overline{WE}$  is LOW and read from the memory if  $\overline{WE}$  is HIGH.

### **OD Output Disable (Input)**

Read cycles can be executed only when OD is LOW.

## FUNCTIONAL DESCRIPTION

### Applications

These memory products provide all of the advantages of AMD's other static N-channel memory circuits: +5 only power supply, all TTL interface, no clocks, no sensing, no refreshing, military temperature range available, low-power versions available, high speed, high output drive, etc. In addition, the Am9111 series features a 256 x 4 organization with common pins used for both Data In and Data Out signals.

This bussed I/O approach cuts down the package pin count allowing the design of higher density memory systems. It also provides a direct interface to bus-oriented systems, eliminating bussing logic that could otherwise be required. Most microprocessor systems, for example, transfer information on a bidirec-

tional data bus. The Am9111 memories can connect directly to such a processor since the common I/O pins act as a bidirectional data bus.

The Output Disable control signal is provided to prevent signal contention for the bus lines, and to simplify tri-state bus control in the external circuitry. If the chip is enabled and the output is enabled and the memory is in the Read state, then the output buffers will be impressing data on the bus lines. At that point, if the external system tries to drive the bus with data, in preparation for a write operation, there will be conflict for domination of the bus lines. The Output Disable signal allows the user direct control over the output buffers, independent of the state of the memory. Although there are alternative ways to resolve the conflict, normally Output Disable will be held HIGH during a write operation.

### ABSOLUTE MAXIMUM RATINGS (Note 1)

Storage Temperature .....	-65 to +150°C
Ambient Temperature with Power Applied .....	-55 to +125°C
Supply Voltage .....	-0.5 V to +7.0 V
DC Voltage Applied to Outputs .....	-0.5 V to +7.0 V
DC Layout Voltage .....	-0.5 V to +7.0 V
Power Description .....	1.0 W
DC Output Current .....	20 mA

Stresses above those listed under ABSOLUTE MAXIMUM RATINGS may cause permanent device failure. Functionality at or above these limits is not implied. Exposure to absolute maximum ratings for extended periods may affect device reliability.

### OPERATING RANGES (Note 2)

Commercial (C) Devices	Temperature .....	0 to +70°C
	Supply Voltage .....	+4.75 V to +5.25 V
Military (M) Devices*	Temperature .....	-55 to +125°C
	Supply Voltage .....	+4.5 V to +5.5 V

Operating ranges define those limits between which the functionality of the device is guaranteed.

\*Military product 100% tested at  $T_C = +25^\circ\text{C}$ ,  $+125^\circ\text{C}$ , and  $-55^\circ\text{C}$ .

### DC CHARACTERISTICS over operating range unless otherwise specified\*

Parameter Symbol	Parameter Description	Test Conditions		Am9111/ Am91L11		Am2111		Units
				Min.	Max.	Min.	Max.	
V <sub>OH</sub>	Output HIGH Voltage	V <sub>CC</sub> = Min.	I <sub>OH</sub> = -200 $\mu$ A I <sub>OH</sub> = -150 $\mu$ A	2.4			2.2	V
V <sub>OL</sub>	Output LOW Voltage	V <sub>CC</sub> = Min.	I <sub>OL</sub> = 3.2 mA I <sub>OL</sub> = 2.0 mA		0.4		0.45	V
V <sub>IH</sub>	Input HIGH Voltage			2.0	V <sub>CC</sub>	2.0	V <sub>CC</sub>	V
V <sub>IL</sub>	Input LOW Voltage			-0.5	0.8	-0.5	0.65	V
I <sub>I</sub>	Input Load Current	V <sub>CC</sub> = Max., 0 $\leq$ V <sub>IN</sub> $\leq$ V <sub>CC</sub>			10		10	$\mu$ A
I <sub>LO</sub>	Output Leakage Current	V <sub>CE</sub> = V <sub>IH</sub>	V <sub>O</sub> = V <sub>CC</sub> V <sub>O</sub> = 0.4 V	C devices M devices	5.0 10		15 -50	$\mu$ A
I <sub>CC1</sub>	Power Supply Current	Data Out Open V <sub>CC</sub> = Max. V <sub>IN</sub> = V <sub>CC</sub>	T <sub>A</sub> = 25°C (Note 3)	Am9111A/B	50			mA
				Am9111	55			
				Am9111	31			
				Am91L11C/D/E	34			
				Am2111			60	
				Am9111	55			
				Am9111	60			
				Am91L11A/B	33			
				Am91L11C/D/E	36			
				Am2111			70	
				Am9111A/B	60			
				Am9111C/D/E	65			
Am9111	37							
Am9111	40							
Am2111								
C <sub>IN</sub>	Input Capacitance	T <sub>A</sub> = 25°C, f = 1 MHz, V <sub>IN</sub> = 0 V (Note 3)			9		9	pF
C <sub>O</sub>	Output Capacitance	T <sub>A</sub> = 25°C, f = 1 MHz, V <sub>O</sub> = 0 V (Note 3)			12		15	pF

- Notes: 1. Absolute maximum ratings are intended for user guidelines and are not tested.  
 2. For test and correlation purposes, ambient temperature is defined as the stabilized case temperature.  
 3. Guaranteed by characterization data. Data will be updated upon any process or design change which affects this parameter.  
 4. Test conditions assume signal transition times of 10 ns or less. Output load equals 1 TTL gate + 100 pF. Input signal timing reference level = 1.5 V, with input pulse levels of 0 to 3.0 V. Data output timing reference levels = 0.8 and 2.0 V.  
 5. Both  $\overline{\text{CE1}}$  and  $\overline{\text{CE2}}$  must be true to enable the chip.

\*See the last page of this spec for Group A Subgroup Testing information.

**STANDBY OPERATING CONDITIONS** over temperature range unless otherwise specified

Parameter Symbol	Parameter Description	Test Conditions		Min.	Typ.	Max.	Units
V <sub>PD</sub>	V <sub>CC</sub> in Standby Mode			1.5			
I <sub>PD</sub>	I <sub>CC</sub> in Standby Mode	T <sub>A</sub> = 0°C All Inputs = V <sub>PD</sub>	V <sub>PD</sub> = 1.5 V	Am91L11	11	25	mA
				Am9111	13	31	
			V <sub>PD</sub> = 2.0 V	Am91L11	13	31	
				Am9111	17	41	
		T <sub>A</sub> = -55°C All Inputs = V <sub>PD</sub>	V <sub>PD</sub> = 1.5 V	Am91L11	11	28	mA
				Am9111	13	34	
			V <sub>PD</sub> = 2.0 V	Am91L11	13	34	
				Am9111	17	46	
dv/dt	Rate of Change of V <sub>CC</sub>					1.0	V/μs
t <sub>R</sub>	Standby Recovery Time			t <sub>RC</sub>			ns
t <sub>CP</sub>	Chip Deselect Time			0			ns
V <sub>CES</sub>	CE Bias in Standby			V <sub>PD</sub>			Volts

**Power-Down Standby Operation**

The Am9111/Am91L11 Family is designed to maintain storage in a standby mode. The standby mode is entered by lowering V<sub>CC</sub> to around 1.5–2.0 volts (see table and graph below). When the voltage to the device is reduced, the storage cells are isolated from the data lines, so their contents will not change. The standby mode may be used by a battery operated

backup power supply system, or, in a large system, memory pages not being accessed can be placed in standby to save power. A standby recovery time must elapse following restoration of normal power before the memory may be accessed.

To ensure that the output of the device is in a high-impedance OFF state during standby, the chip select should be held at V<sub>IH</sub> or V<sub>CES</sub> during the entire standby cycle.



# TYPICAL DC AND AC CHARACTERISTICS

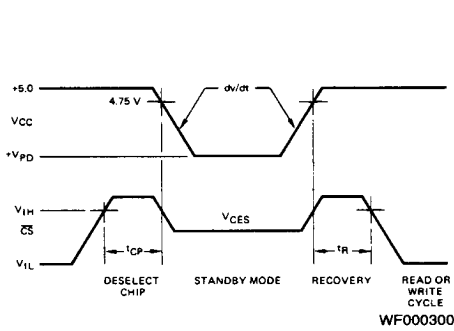

Typical Power Supply Current Versus Voltage

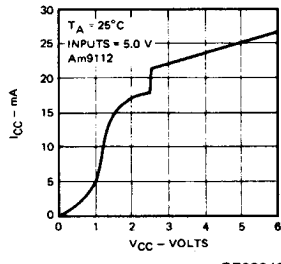

Typical Output Current Versus Voltage

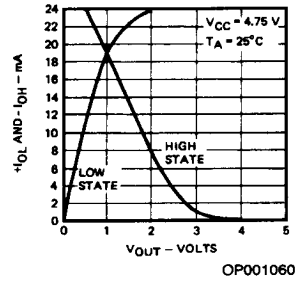

Access Time Versus  $V_{CC}$  Normalized to  $V_{CC} = +5.0$  Volts

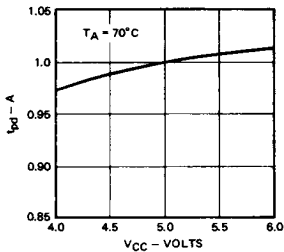

Typical Power Supply Current Versus Ambient Temperature

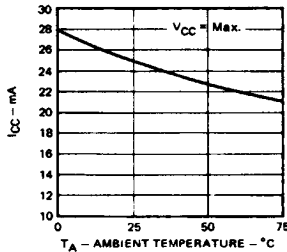

Typical  $V_{IN}$  Limits Versus Ambient Temperature

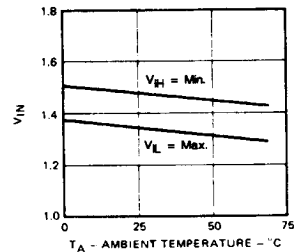

Typical  $t_A$  Versus Ambient Temperature

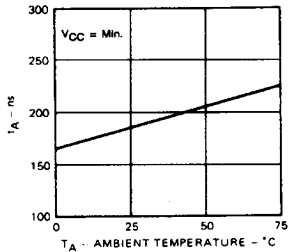

Typical  $t_A$  Versus  $C_L$

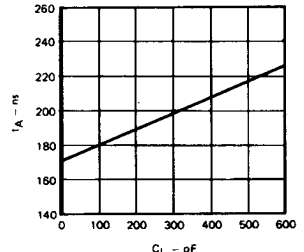

**SWITCHING CHARACTERISTICS** over operating range unless otherwise specified (Note 4)\*

No.	Parameter Symbol	Parameter Description	Am2111		Am2111-2		Am2111-1		Units
			Min.	Max.	Min.	Max.	Min.	Max.	
1	t <sub>RC</sub>	Read Cycle Time	1000		650		500		ns
2	t <sub>A</sub>	Access Time		1000		650		500	ns
3	t <sub>CO</sub>	Chip Enable to Output ON Delay (Note 5)		800		400		350	ns
4	t <sub>OD</sub>	Output Disable to Output ON Delay		700		350		300	ns
5	t <sub>OH</sub>	Previous Read Data Valid with Respect to Address Change	0		0		0		ns
6	t <sub>DF1</sub>	Output Disable to Output OFF Delay (Note 3)	0	200	0	150	0	150	ns
7	t <sub>DF2</sub>	Chip Enable to Output OFF Delay (Note 3)	0	200	0	150	0	150	ns
8	t <sub>WC</sub>	Write Cycle Time	1000		650		500		ns
9	t <sub>AW</sub>	Address Set-up Time	150		150		100		ns
10	t <sub>WP</sub>	Write Pulse Width	750		400		300		ns
11	t <sub>CW</sub>	Chip Enable Set-up Time (Note 1)	900		550		400		ns
12	t <sub>WR</sub>	Address Hold Time	50		50		50		ns
13	t <sub>DW</sub>	Input Data Set-up Time	700		400		280		ns
14	t <sub>DH</sub>	Input Data Hold Time	100		100		100		ns

No.	Parameter Symbol	Parameter Description	Am9111A Am91L11A		Am9111B Am91L11B		Am9111C Am91L11C		Am9111D		Units
			Min.	Max.	Min.	Max.	Min.	Max.	Min.	Max.	
1	t <sub>RC</sub>	Read Cycle Time	500		400		300		250		ns
2	t <sub>A</sub>	Access Time		500		400		300		250	ns
3	t <sub>CO</sub>	Chip Enable to Output ON Delay (Note 5)		200		175		150		125	ns
4	t <sub>OD</sub>	Output Disable to Output ON Delay		175		150		125		100	ns
5	t <sub>OH</sub>	Previous Read Data Valid with Respect to Address Change	40		40		40		30		ns
6	t <sub>DF1</sub>	Output Disable to Output OFF Delay	5.0	125	5.0	100	5.0	100	5.0	75	ns
7	t <sub>DF2</sub>	Chip Enable to Output OFF Delay	10	150	10	125	10	125	10	100	ns
8	t <sub>WC</sub>	Write Cycle Time	500		400		300		250		ns
9	t <sub>AW</sub>	Address Set-up Time	20		20		20		20		ns
10	t <sub>WP</sub>	Write Pulse Width	225		200		175		150		ns
11	t <sub>CW</sub>	Chip Enable Set-up Time (Note 5)	175		150		125		100		ns
12	t <sub>WR</sub>	Address Hold Time	0		0		0		0		ns
13	t <sub>DW</sub>	Input Data Set-up Time	150		125		100		85		ns
14	t <sub>DH</sub>	Input Data Hold Time	15		15		15		15		ns

See notes following DC Characteristics table.

\*See the last page of this spec for Group A Subgroup Testing information.

4

# SWITCHING WAVEFORMS

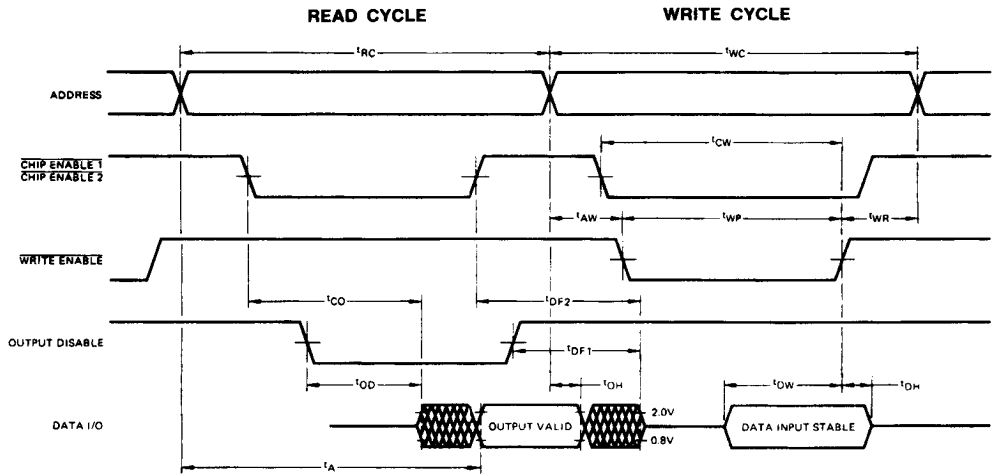

WF000591

## GROUP A SUBGROUP TESTING

### DC CHARACTERISTICS

Parameter Symbol	Subgroups
V <sub>OH</sub>	1, 2, 3
V <sub>OL</sub>	1, 2, 3
V <sub>IH</sub>	1, 2, 3
V <sub>IL</sub>	1, 2, 3
I <sub>LI</sub>	1, 2, 3
I <sub>LO</sub>	1, 2, 3
I <sub>CC1</sub>	1, 2, 3
V <sub>PD</sub>	1, 2, 3
I <sub>PD</sub>	1, 2, 3

### SWITCHING CHARACTERISTICS

No.	Parameter Symbol	Subgroups
1	t <sub>RC</sub>	7, 8, 9, 10, 11
2	t <sub>A</sub>	7, 8, 9, 10, 11
3	t <sub>CO</sub>	7, 8, 9, 10, 11
4	t <sub>OD</sub>	7, 8, 9, 10, 11
5	t <sub>OH</sub>	7, 8, 9, 10, 11
8	t <sub>WC</sub>	7, 8, 9, 10, 11
9	t <sub>AW</sub>	7, 8, 9, 10, 11
10	t <sub>WP</sub>	7, 8, 9, 10, 11
11	t <sub>CW</sub>	7, 8, 9, 10, 11
12	t <sub>WR</sub>	7, 8, 9, 10, 11
13	t <sub>DW</sub>	7, 8, 9, 10, 11
14	t <sub>DH</sub>	7, 8, 9, 10, 11

### MILITARY BURN-IN

Military burn-in is in accordance with the current revision of MIL-STD-883, Test Method 1015, Conditions A through E. Test conditions are selected at AMD's option.