



DUAL HIGH OUTPUT POWER OPERATIONAL AMPLIFIER

NJM3414

The NJM3414 integrated circuit is a high gain, high output current, high output voltage swing dual operational amplifier capable of driving 70mA.

Absolute Maximum Ratings (Ta=25°C)

Supply Voltage	V ⁺ (V ⁺ /V ⁻)	15V (or ±7.5V)
Differential Input Voltage	V _{ID}	15V
Input Voltage	V _I	-0.3 ~ +15V
Power Dissipation	P _D (D-Type)	500mW
	(M-Type)	300mW
	(L-Type)	800mW
Operating Temperature Range	T _{opr}	-20 ~ +75°C
Storage Temperature Range	T _{stg}	-40 ~ +125°C

Package Outline

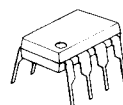

NJM3414D



NJM3414M

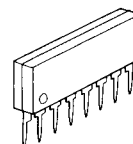

NJM3414L

Electrical Characteristics (Ta=25°C, V⁺=8.6V)

Parameter	Symbol	Test Condition	Min.	Typ.	Max.	Unit
Input Offset Voltage	V _{IO}	R _S =0Ω	—	2	5	mV
Input Offset Current	I _{IO}		—	±30	±100	nA
Input Bias Current	I _B		—	100	500	nA
Large Signal Voltage Gain	A _v	R _L =2kΩ	88	100	—	dB
Input Common Voltage Range	V _{ICM}		V ⁺ -2	—	—	V
Maximum Output Voltage Swing 1	V _{OM1}	R _L ≥2kΩ, V ⁺ =5V	3.5	—	—	V
Maximum Output Voltage Swing 2	V _{OM2}	I _O =70mA, V ⁺ =5V	3.2	—	—	V
Common Mode Rejection Ratio	CMR		80	90	—	dB
Supply Voltage Rejection Ratio	SVR		80	90	—	dB
Supply Current	I _{CC}	R _L =∞	—	4	5	mA
Slew Rate	SR		—	1.0	—	V/μS
Unity Gain Bandwidth	GB		—	1.3	—	MHz
Operating Voltage Range	V ⁺		—	—	10	V

Equivalent Circuit (1/2 Shown)

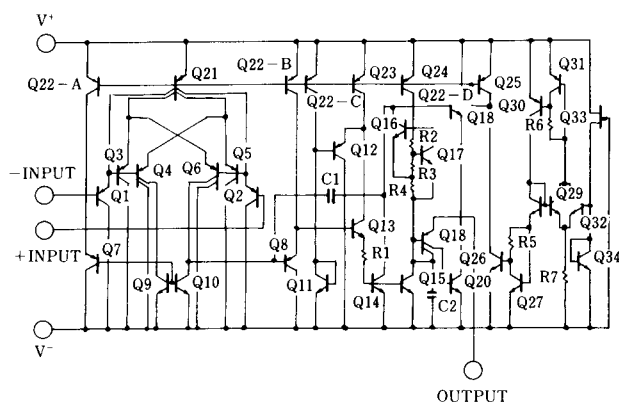

Connection Diagrams

D,M-Type
(Top View)

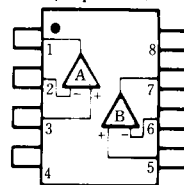

PIN FUNCTION

1. A OUTPUT
2. A-INPUT
3. A+INPUT
4. GND
5. B+INPUT
6. B-INPUT
7. B OUTPUT
8. V⁺

L-Type

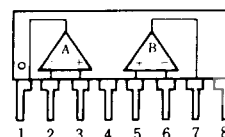

■ Typical Characteristics

Input Offset Voltage vs. Ambient Temperature
($V^+ = 5V$)

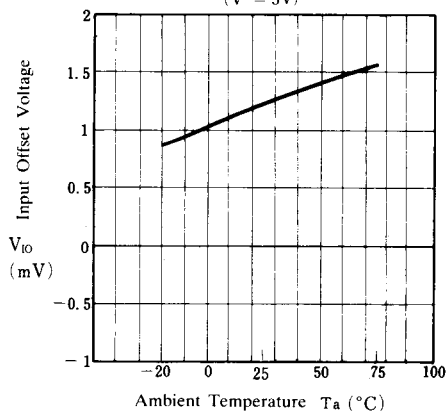

Input Bias Current vs. Ambient Temperature
($V^+ = 5V$)

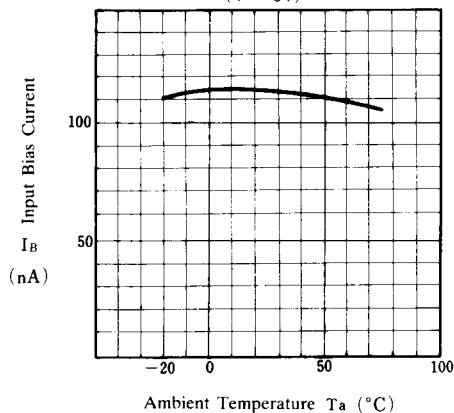

Output Source Current vs. V_{sat}^+
($V^+ = 5V, T_a = 25°C$)

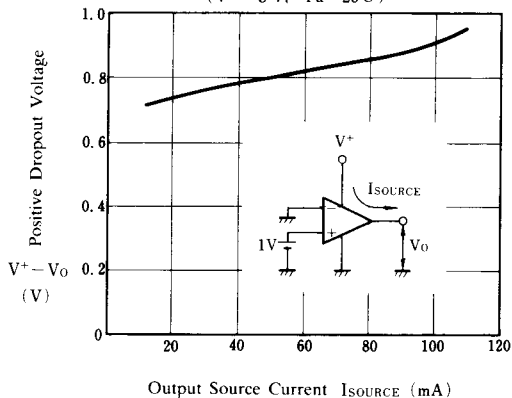

Output Sink Current vs. V_{sat}^-
($V^+ = 5V, T_a = 25°C$)

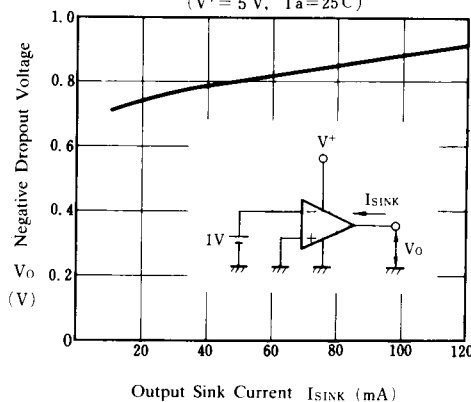

Supply Voltage vs. Quiescent Current
($T_a = 25°C$)

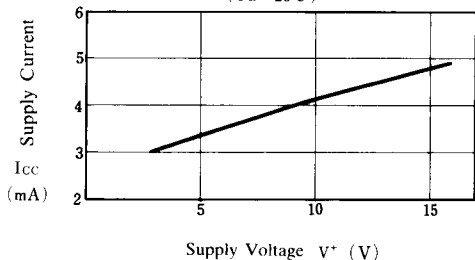

Maximum Output Voltage
($V^+ = 5V, I_o = 70mA$)

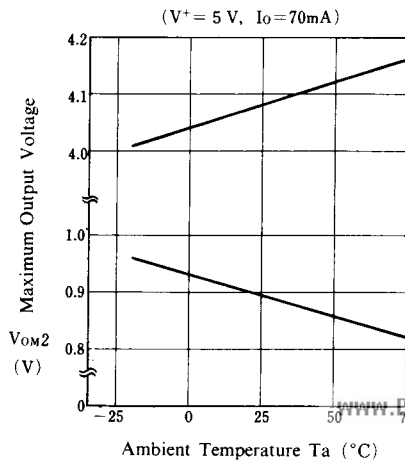

NJM3414

■ Typical Characteristics

