

ATS612LSG

DYNAMIC, SELF-CALIBRATING, PEAK-DETECTING, DIFFERENTIAL HALL-EFFECT GEAR-TOOTH SENSOR

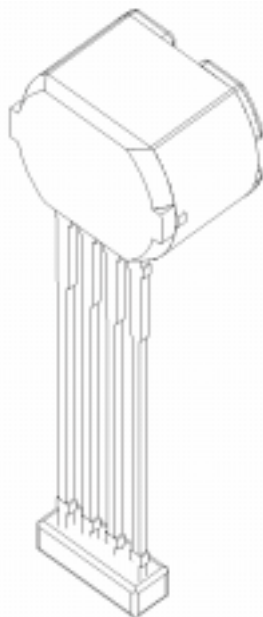

Pin 1: Supply
Pin 2: Output
Pin 3: Capacitor
Pin 4: Ground

ABSOLUTE MAXIMUM RATINGS

Supply Voltage, V_{CC}	24 V
Reverse Supply Voltage, V_{RCC}	-16 V
Output OFF Voltage, V_{OUT}	24 V
Continuous Output Current, I_{OUT}	25 mA
Reverse Output Current, I_{ROUT}	50 mA
Package Power Dissipation, P_D	See Graph
Operating Temperature Range, T_A	-40°C to +150°C
Storage Temperature, T_S	+170°C
Maximum Junction Temperature, T_J	165° C

The ATS612LSG gear-tooth sensor is a peak-detecting device that uses automatic gain control to provide extremely accurate gear edge detection down to low operating speeds. Each sensor module consists of an over-molded package, which holds together a samarium-cobalt magnet, a pole piece and a differential open-collector Hall IC that has been optimized to the magnetic circuit. This small package can be easily assembled and used in conjunction with a wide variety of gear shapes and sizes.

The sensor incorporates a dual-element Hall IC that switches in response to differential magnetic signals created by ferrous targets. The sophisticated processing circuitry contains a 5-bit D/A converter that self-calibrates (normalizes) the internal gain of the device to minimize the effect of air-gap variations. The patented peak-detecting filter circuit eliminates magnet and system offsets and has the ability to discriminate relatively fast changes such as those caused by tilt, gear wobble, and other eccentricities, yet provides stable operation to extremely low RPM.

This sensor system is ideal for use in gathering speed, position, and timing information using gear-tooth-based configurations. The ATS612 is particularly suited to those applications that require extremely accurate duty cycle control or accurate edge detection such as in automotive crankshaft applications. The lower vibration sensitivity also makes this device extremely useful for transmission speed sensing.

FEATURES AND BENEFITS

- ♦ Fully Optimized Differential Digital Gear-Tooth Sensor
- ♦ Single-Chip Sensing IC for High Reliability
- ♦ Digital Output Representing Target Profile
- ♦ Extremely Low Timing Accuracy Drift with Temperature
- ♦ Large Operating Air Gaps
- ♦ Small Mechanical Size
- ♦ Optimized Magnetic Circuit
- ♦ Patented Peak-Detecting Filter:
 - 80 μ s Typical Power-On Time
 - <10 RPM Operation (single-tooth target)
 - Uses Small Value Ceramic Capacitors
- ♦ Under-Voltage Lockout
- ♦ Wide Operating Voltage Range
- ♦ Defined Power-On State

ATS612LSG
 DYNAMIC, SELF-CALIBRATING, PEAK-DETECTING,
 DIFFERENTIAL HALL-EFFECT GEAR TOOTH SENSOR

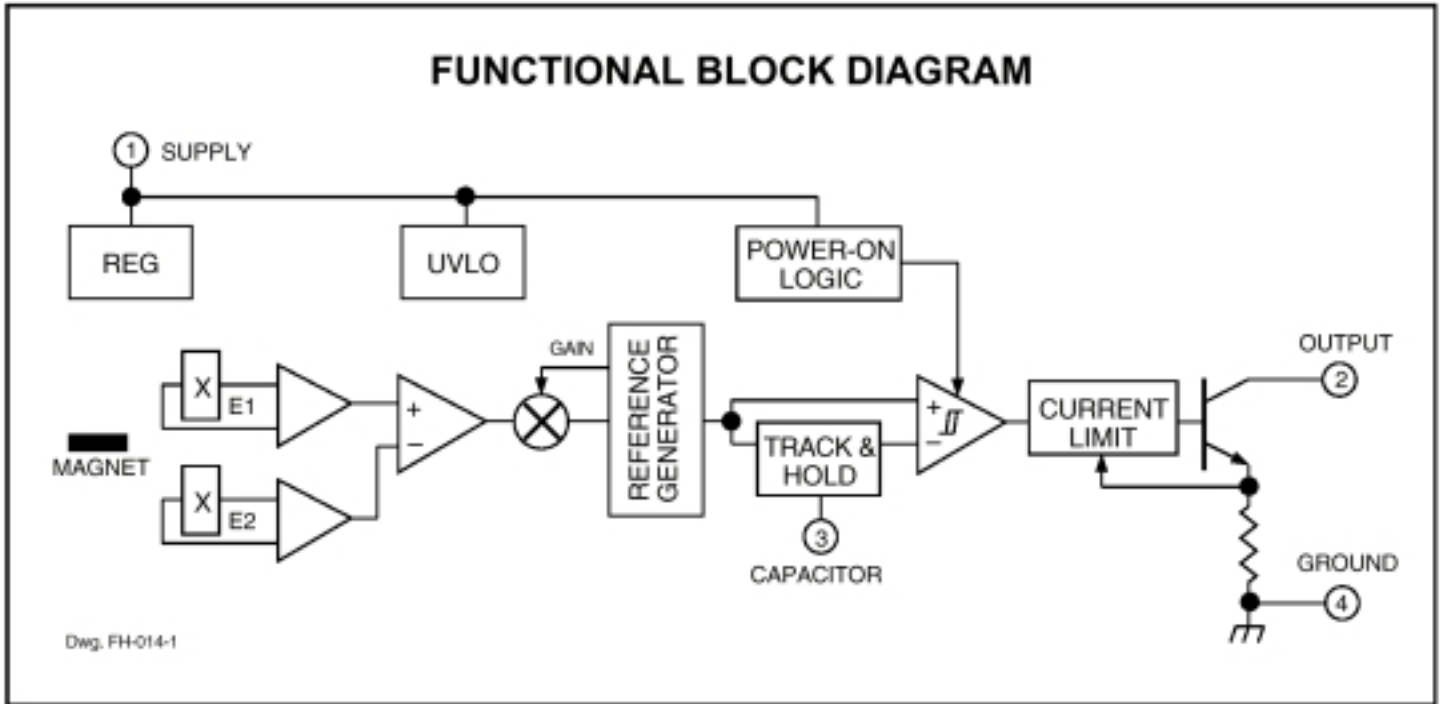

Timing Diagrams

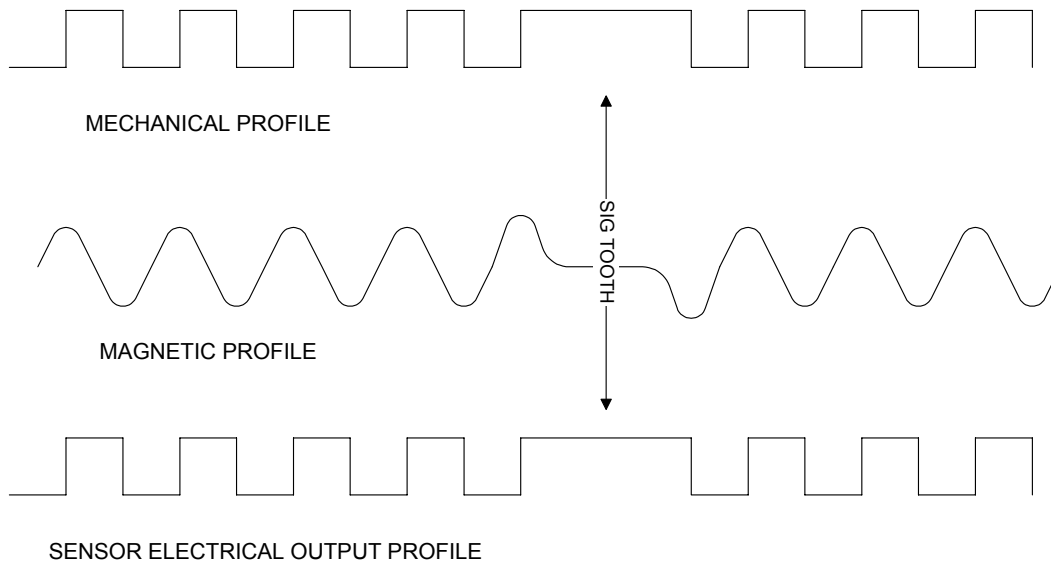

NOTE: Output polarity is dependent upon sensor orientation and target rotation. See Output Polarity description on page 9.

ATS612LSG
 DYNAMIC, SELF-CALIBRATING, PEAK-DETECTING,
 DIFFERENTIAL HALL-EFFECT GEAR TOOTH SENSOR

**ELECTRICAL CHARACTERISTICS over operating voltage and temperature range,
 $C_3 = 0.1 \mu\text{F}$ to $0.47 \mu\text{F}$.**

Characteristic	Symbol	Test Condition	Limits			
			Min.	Typ.	Max.	Units
Supply Voltage	V_{CC}	Operating, $T_J < 165^\circ\text{C}$	3.6	—	24	V
Power-On State	POS	$V_{CC} = 0 \rightarrow 5 \text{ V}$	HIGH	HIGH	HIGH	—
Under-Voltage Lockout	$V_{CC(UV)}$	$V_{CC} = 0 \rightarrow 5 \text{ V}$	2.5	—	3.6	V
Under-Voltage Hysteresis	$V_{CC(hys)}$	$V_{CC(UV)} - V_{CC(SD)}$ (see NOTE below)	—	0.2	—	V
Low Output Voltage	$V_{OUT(SAT)}$	$I_{OUT} = 20 \text{ mA}$	—	185	400	mV
Supply Zener Clamp Voltage	V_Z	$I_{CC} = 18 \text{ mA}$	24	—	—	V
Output Current Limit	I_{OUTM}	$V_{OUT} = 12 \text{ V}$	25	45	55	mA
Output Leakage Current	I_{OFF}	$V_{OUT} = 24 \text{ V}$	—	0.2	15	μA
Supply Current	I_{CC}	Output OFF	6.0	8.7	13	mA
		Output ON	8.0	10.7	15	mA
Power-On Delay	t_{on}	$V_{CC} > 5 \text{ V}$	—	80	500	μs
Output Rise Time	t_r	$R_L = 500 \Omega$, $C_L = 10 \text{ pF}$	—	0.2	5.0	μs
Output Fall Time	t_f	$R_L = 500 \Omega$, $C_L = 10 \text{ pF}$	—	0.2	5.0	μs

NOTES: Typical data is at $V_{CC} = 8 \text{ V}$ and $T_A = +25^\circ\text{C}$ and is for design information only.
 $V_{CC(SD)}$ = shutdown voltage, $V_{CC} = 5 \text{ V} \rightarrow 0$.

ATS612LSG
 DYNAMIC, SELF-CALIBRATING, PEAK-DETECTING,
 DIFFERENTIAL HALL-EFFECT GEAR TOOTH SENSOR

OPERATION over operating voltage and temperature range with reference target (unless otherwise specified).

Characteristic	Symbol	Test Condition	Limits			
			Min.	Typ.	Max.	Units
Air Gap Range	AG	Operating within specification, Target Speed > 20 RPM	0.4	—	2.25	mm
Calibration Cycle	n_{cal}	Output edges before which Calibration is completed*	1	1	1	Edge
Calibration Mode Disable	n_{dis}	Output falling edges for startup calibration to be complete	64	64	64	Edges
Relative Timing Accuracy, Sequential	t_{θ}	Target Speed = 1000 RPM, $0.4 \text{ mm} \leq \text{AG} \leq 2 \text{ mm}$	—	± 0.3	± 0.9	$^{\circ}$
Allowable User Induced Differential Offset		Output switching only; may not meet data sheet specifications	—	—	± 50	G

* Non-uniform magnetic profiles may require additional output pulses before calibration is complete.

ATS612LSG
 DYNAMIC, SELF-CALIBRATING, PEAK-DETECTING,
 DIFFERENTIAL HALL-EFFECT GEAR TOOTH SENSOR

REFERENCE TARGET / GEAR INFORMATION

Diameter	120	mm
Thickness	6	mm
Sequential Tooth Width	3	mm
Sequential Valley Width	3	mm
Sequential Valley Depth	3	mm
Signature Tooth Width	9	mm
Material	Low carbon steel	

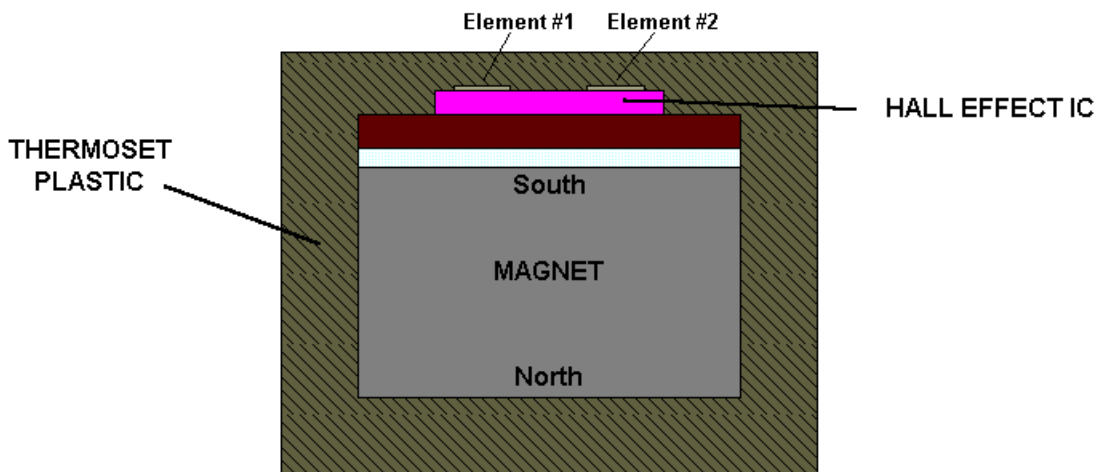
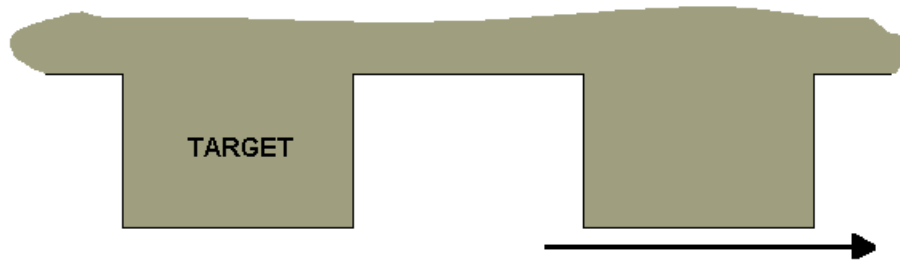
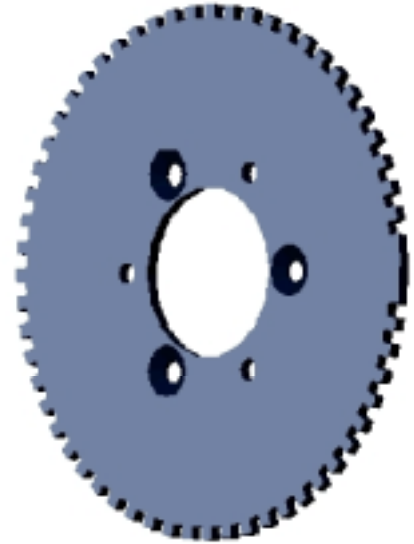

ATS612LSG

DYNAMIC, SELF-CALIBRATING, PEAK-DETECTING, DIFFERENTIAL HALL-EFFECT GEAR TOOTH SENSOR

POWER DE-RATING

Due to internal power consumption, the temperature of the IC (junction temperature, T_J) is higher than the ambient environment temperature, T_A . To ensure that the device does not operate above the maximum rated junction temperature use the following calculations:

$$\Delta T = P_D \times R_{\theta JA}$$

Where: $P_D = V_{CC} \times I_{CC}$

$$\therefore \Delta T = V_{CC} \times I_{CC} \times R_{\theta JA}$$

Where ΔT denotes the temperature rise resulting from the IC's power dissipation.

$$T_J = T_A + \Delta T$$

For the sensor :

$$T_{J(max)} = 165^\circ\text{C}$$

$$R_{\theta JA} = 126^\circ\text{C/W}$$

Typical T_J calculation:

$$T_A = 25^\circ\text{C}$$

$$V_{CC} = 5\text{ V}$$

$$I_{CC} = (I_{CC(ON)typ} + I_{CC(OFF)typ}) / 2 = (10.7\text{ mA} + 8.7\text{ mA}) / 2 = 9.7\text{ mA}$$

$$P_D = V_{CC} \times I_{CC} = 5\text{ V} \times 9.7\text{ mA} = 48.5\text{ mW}$$

$$\Delta T = P_D \times R_{\theta JA} = 48.5\text{ mW} \times 126^\circ\text{C/W} = 8.0^\circ\text{C}$$

$$T_J = T_A + \Delta T = 25^\circ\text{C} + 8.0^\circ\text{C} = 33.0^\circ\text{C}$$

Maximum Allowable Power Dissipation Calculation for ATS612LSG:

Assume:

$$T_A = T_{A(max)} = 150^\circ\text{C}$$

$$T_{J(max)} = 165^\circ\text{C}$$

$$I_{CC} = (I_{ON(max)} + I_{OFF(max)}) / 2$$

$$= (15\text{ mA} + 13\text{ mA}) / 2 = 14\text{ mA}$$

If:

$$T_J = T_A + \Delta T$$

Then:

$$\Delta T_{(max)} = T_{J(max)} - T_{A(max)} = 165^\circ\text{C} - 150^\circ\text{C} = 15^\circ\text{C}$$

If:

$$\Delta T = P_D \times R_{\theta JA}$$

then:

$$P_{D(max)} = \Delta T_{(max)} / R_{\theta JA} = 15^\circ\text{C} / 126^\circ\text{C/W} = 119\text{ mW}$$

If:

$$P_D = V_{CC} \times I_{CC}$$

then the maximum V_{CC} at 150°C is therefore:

$$V_{CC(max)} = P_{D(max)} / I_{CC} = 119\text{ mW} / 15\text{ mA} = 7.9\text{ V}$$

This value applies only to the voltage drop across the ATS612 chip. If a protective series diode or resistor is used, the effective maximum supply voltage is increased.

For example, when a standard diode with a 0.7 V drop is used:

$$V_{S(max)} = 7.9\text{ V} + 0.7\text{ V} = 8.6\text{ V}$$

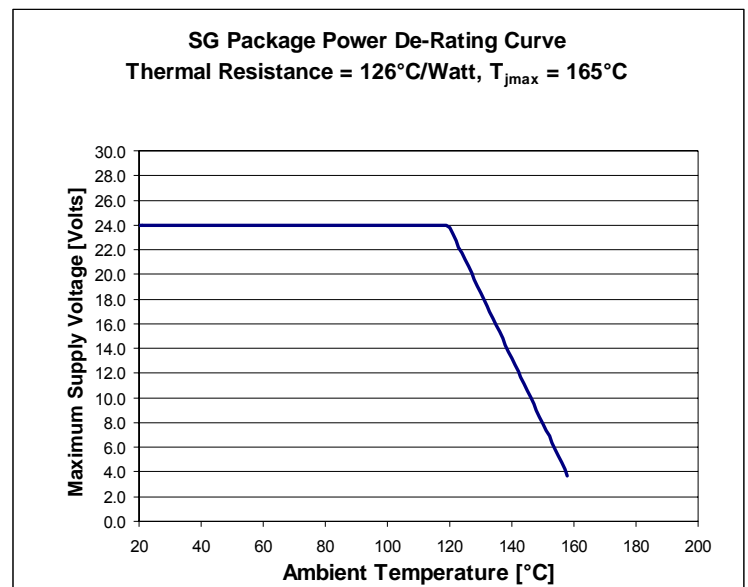

ATS612LSG

DYNAMIC, SELF-CALIBRATING, PEAK-DETECTING, DIFFERENTIAL HALL-EFFECT GEAR TOOTH SENSOR

DEVICE DESCRIPTION

Assembly Description. The ATS612 gear-tooth sensor is a Hall IC/magnet configuration that is fully optimized to provide digital detection of gear tooth edges. This sensor is packaged in a molded miniature plastic body that has been optimized for size, ease of assembly, and manufacturability. High operating temperature materials are used in all aspects of construction.

The use of this sensor is simple. After proper power is applied to the component the sensor is then capable of instantly providing digital information that is representative of the profile of a rotating gear. No additional optimization or processing circuitry is required. This ease of use should reduce design time and incremental assembly costs for most applications.

Sensing Technology. The gear tooth sensor module contains a single-chip differential Hall effect sensor IC, a Samarium Cobalt magnet, and a flat ferrous pole piece (Figure 2). The Hall IC consists of 2 Hall elements (spaced 2.2 mm apart) located so as to measure the magnetic gradient created by the passing of a ferrous object. The two elements measure the magnetic gradient and convert it to an analog voltage that is then processed in order to provide a digital output signal.

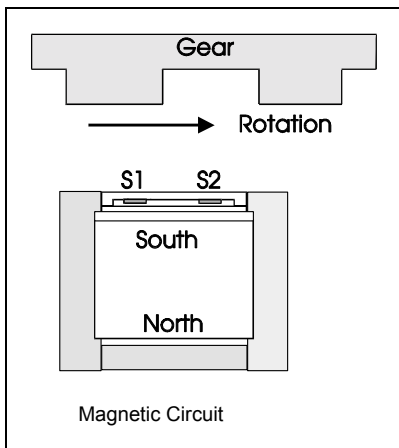
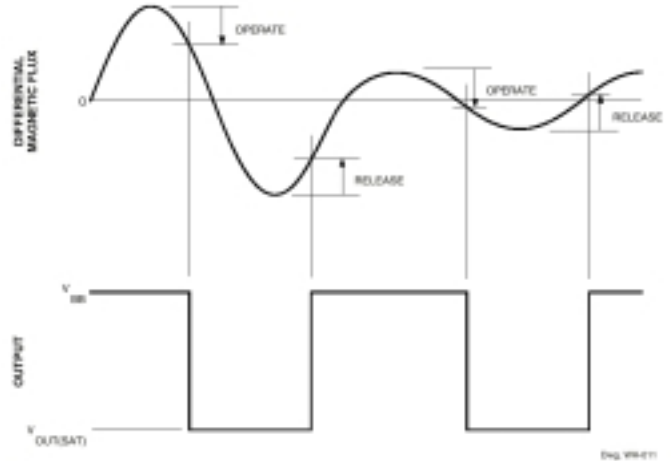

Figure 2

Internal Electronics. The processing circuit uses a patented peak detection scheme to eliminate magnet and system offsets. This technique allows dynamic coupling and filtering of offsets without the power-up and settling time disadvantages of classical high-pass filtering schemes. The peak signal of every tooth and valley is detected by the filter and is used to provide an instant reference for the operate and release point

comparator. In this manner, the thresholds are adapted and referenced to individual signal peaks and valleys, providing immunity to zero line variation from installation inaccuracies (tilt, rotation, and off center placement), as well as for variations caused by target and shaft eccentricities. The peak detection concept also allows extremely low speed operation for small value filter capacitors.



The ATS612 also includes self-calibration circuitry that is engaged at power on. The signal amplitude is measured and the device gain is normalized. In this manner, switch-point drift versus air gap is minimized and excellent timing accuracy can be achieved. The AGC (Automatic Gain Control) circuitry, in conjunction with a unique hysteresis circuit, also eliminates the effect of gear edge overshoot as well as increases the immunity to false switching caused by gear tooth anomalies at close air gap. The AGC circuit sets the gain of the device after power on. Up to 0.25 mm air gap change can occur after calibration is complete without significant performance impact.

Superior Performance. The ATS612 peak-detecting differential gear-tooth sensor module has several advantages over conventional Hall-effect gear-tooth sensors. The signal-processing techniques used in the ATS612 solve the catastrophic issues that affect the functionality of conventional digital gear-tooth sensors.

- **Temperature drift.** Changes in temperature do not greatly affect this device due to the stable amplifier design and the offset rejection circuitry.
- **Timing accuracy variation due to air gap.** The accuracy variation caused by air gap changes is minimized by the self-calibration circuitry. A 2x-to-3x improvement can be seen.

ATS612LSG

DYNAMIC, SELF-CALIBRATING, PEAK-DETECTING, DIFFERENTIAL HALL-EFFECT GEAR TOOTH SENSOR

- **Dual edge detection.** Because this device switches from the positive and negative peaks of the signal, dual edge detection is guaranteed.
- **Tilted or off-center installation.** Traditional differential sensors will switch incorrectly due to baseline changes versus air gap caused by tilted or off-center installation. The peak detector circuitry references the switch point from the peak and is immune to this failure mode. There may be a timing accuracy shift caused by this condition.
- **Large operating air gaps.** Large operating air gaps are achievable with this device due to the sensitive switch points after start up. (dependent on target dimensions, material, and speed).
- **Immunity to magnetic overshoot.** The air gap-independent hysteresis minimizes the impact of overshoot on the switching of device output.
- **Response to surface defects in the target.** The gain-adjust circuitry reduces the effect of minor gear anomalies that would normally cause false switching.
- **Immunity to vibration and backlash.** The gain-adjust circuitry keeps the hysteresis of the device roughly proportional to the peak-to-peak signal. This allows the device to have good immunity to vibration even when operating at close air gaps.
- **Immunity to gear run out.** The differential sensor configuration eliminates the baseline variations caused by gear run out.

Differential vs. Single-Element Sensing. The differential Hall-effect configuration is superior in most applications to the classical single-element gear-tooth sensor. As shown in the flux maps on this page, the single-element configuration commonly used (Hall-effect sensor mounted on the face of a simple permanent magnet) requires the detection of a small signal (often <100 G) that is superimposed on a large back-biased field, often 1500 G to 3500 G. For most gear/target configurations, the back-biased field values change due to concentration effects, resulting in a varying baseline with air gap, with valley widths, with eccentricities, and with vibration. The differential configuration cancels the effects of the back-biased field and avoids many of the issues presented by the single Hall element.

NOTE: 10 G = 1 mT, exactly.

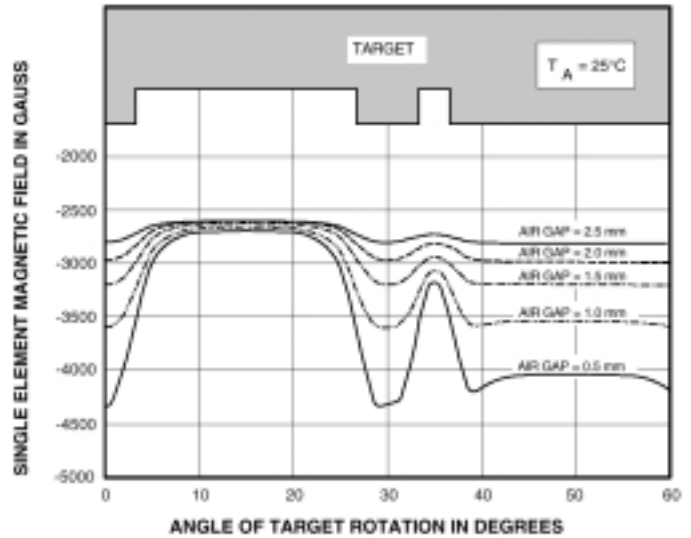

Single-element flux maps
showing the impact of varying valley widths

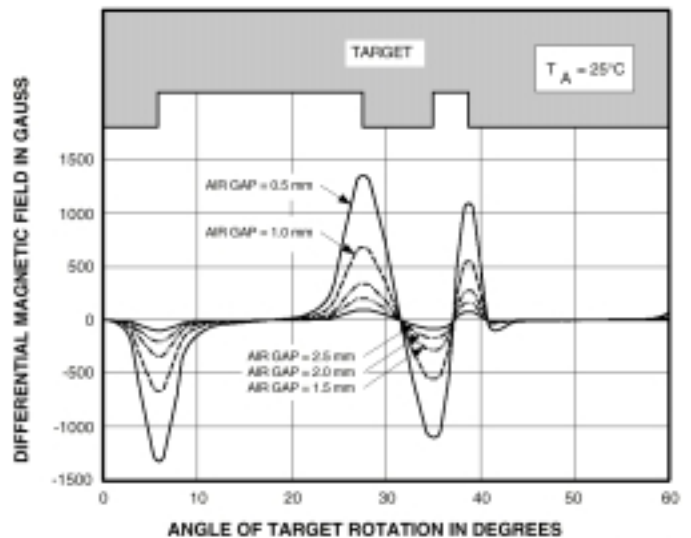

Differential flux maps vs. air gaps

ATS612LSG

DYNAMIC, SELF-CALIBRATING, PEAK-DETECTING, DIFFERENTIAL HALL-EFFECT GEAR TOOTH SENSOR

Peak Detecting vs. AC-Coupled Filters. High-pass filtering (normal AC coupling) is a commonly used technique for eliminating circuit offsets. AC coupling has errors at power on because the filter circuit needs to hold the circuit zero value even though the circuit may power on over a large signal. Such filter techniques can only perform properly after the filter has been allowed to settle, which is typically greater than one second. Also, high-pass filter solutions cannot easily track rapidly changing baselines such as those caused by eccentricities. Peak detection switches on the change in slope of the signal and is baseline independent at power up and during running.

Peak Detecting vs. Zero-Crossing Reference. The usual differential zero-crossing sensors are susceptible to false switching due to off-center and tilted installations which result in a shift of the baseline that changes with air gap. The track-and-hold peak-detection technique ignores baseline shifts versus air gaps and provides increased immunity to false switching. In addition, using track-and-hold peak-detecting techniques, increased air gap capabilities can be expected because a peak detector utilizes the entire peak-to-peak signal range as compared to zero-crossing detectors that switch on one-half the peak-to-peak signal.

NOTE – “Baseline” refers to the zero-gauss differential field where each Hall-effect element is subject to the same magnetic field strength.

Power-On Operation. The device will power on in the OFF state (output high) irrespective of the magnetic field condition. The power-up time of the circuit is no greater than 500 μ s. The circuit is then ready to accurately detect the first target edge that results in a HIGH-to-LOW transition.

Under-Voltage Lockout. When the supply voltage is below the minimum operating voltage ($V_{CC(UV)}$), the

device is OFF and stays OFF irrespective of the state of the magnetic field. This prevents false signals, which may be caused by under-voltage conditions (especially during turn on), from appearing at the output.

Output. The device output is an open-collector stage capable of sinking up to 20 mA. An external pull-up (resistor) to a supply voltage of not more than 24 V must be supplied.

Output Polarity. The output of the unit will switch from HIGH to LOW as the leading edge of the tooth passes the unit in the direction indicated in figure 3 which means that in this configuration, the output voltage will be high when the unit is facing a tooth. If rotation is in the opposite direction, the output polarity will be opposite as well, with the unit switching LOW to HIGH as the leading edge passes the unit.

Figure 3

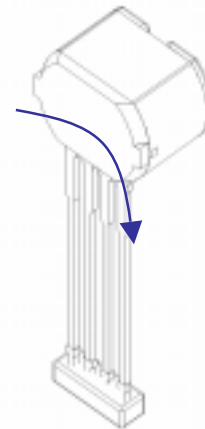

ATS612LSG

DYNAMIC, SELF-CALIBRATING, PEAK-DETECTING,
DIFFERENTIAL HALL-EFFECT GEAR TOOTH SENSOR

TYPICAL ELECTRICAL CHARACTERISTICS

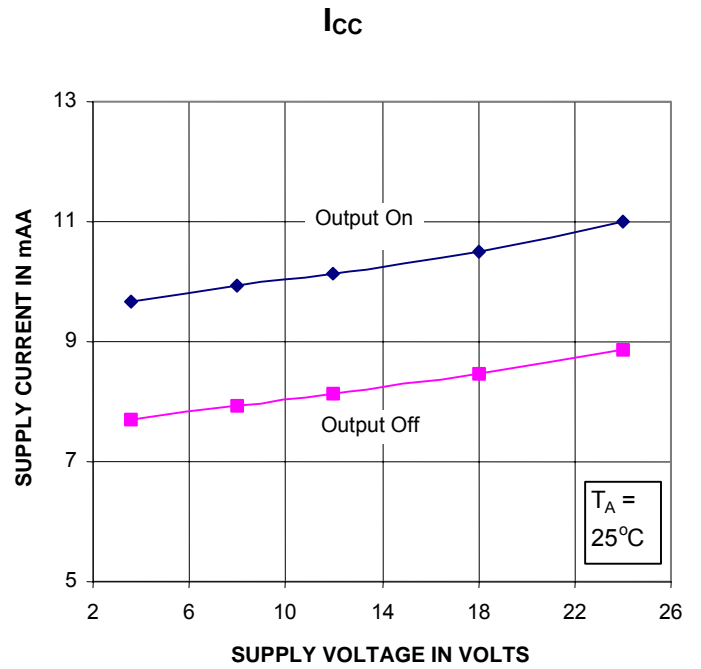
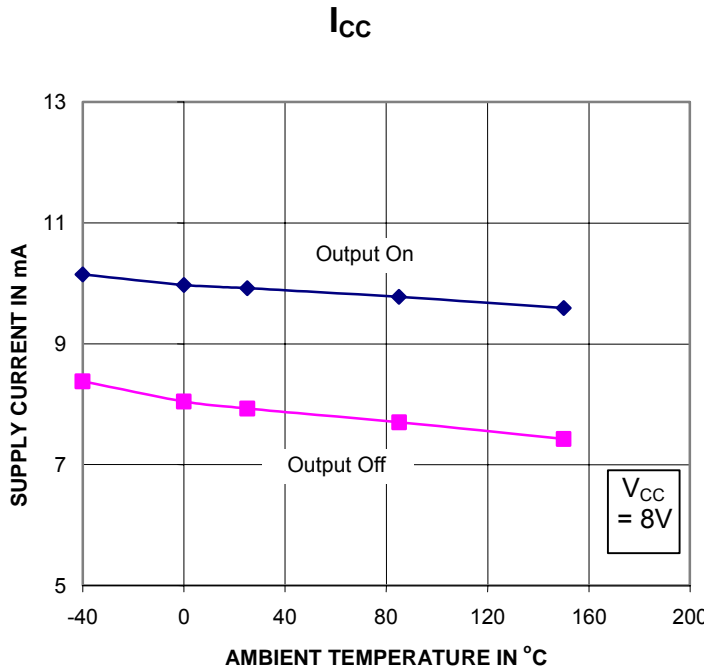

$V_{OUT(SAT)}$

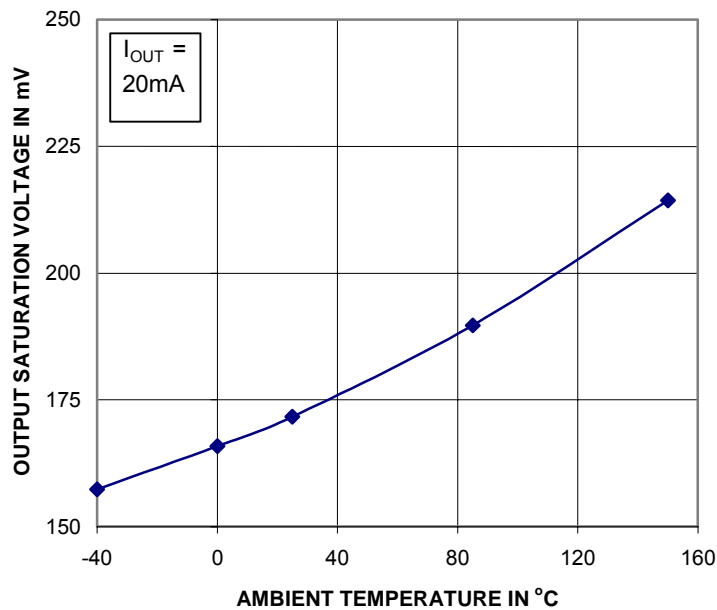

ATS612LSG

DYNAMIC, SELF-CALIBRATING, PEAK-DETECTING,
DIFFERENTIAL HALL-EFFECT GEAR TOOTH SENSOR

TYPICAL OPERATING CHARACTERISTICS

(Relative Accuracy data presented has been normalized to 1.5 mm air gap at 1000 RPM)

Rising signature tooth edge 1000 RPM

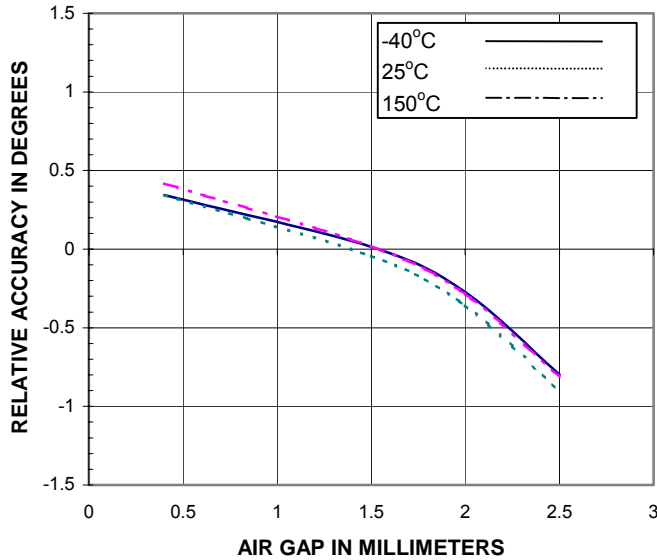

Falling signature tooth edge 1000 RPM

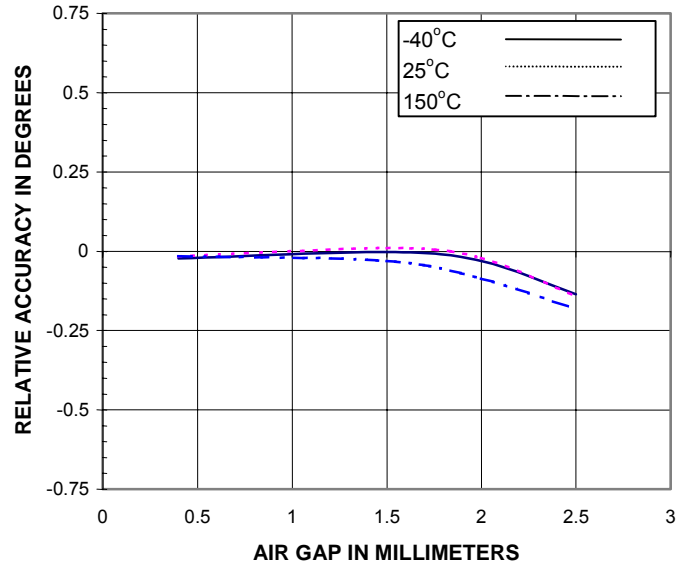

Rising signature tooth edge 10 RPM

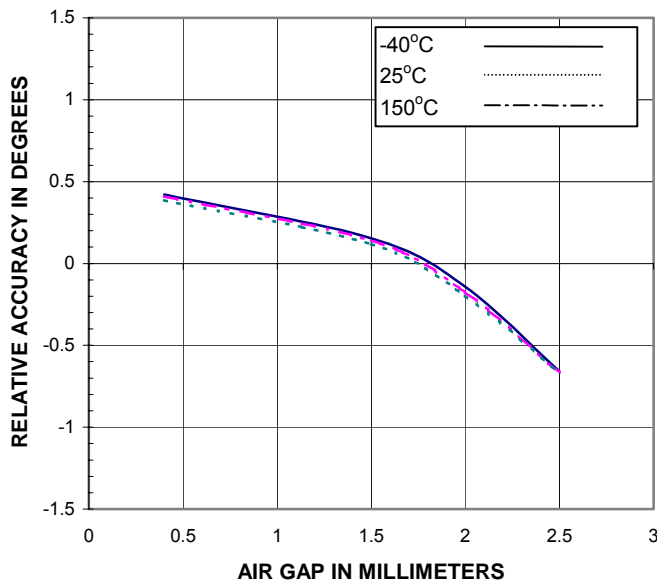

Falling signature tooth edge 10 RPM

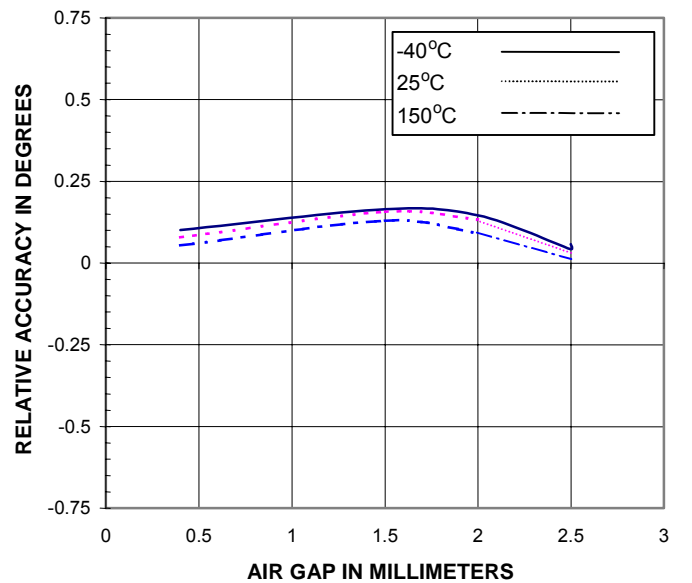

ATS612LSG

DYNAMIC, SELF-CALIBRATING, PEAK-DETECTING,
DIFFERENTIAL HALL-EFFECT GEAR TOOTH SENSOR

TYPICAL OPERATING CHARACTERISTICS

Rising sequential tooth edge 1000 RPM

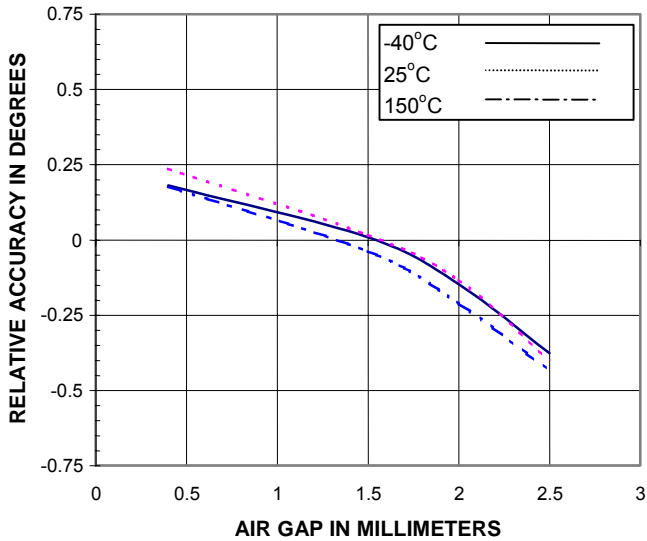

Falling sequential tooth edge 1000 RPM

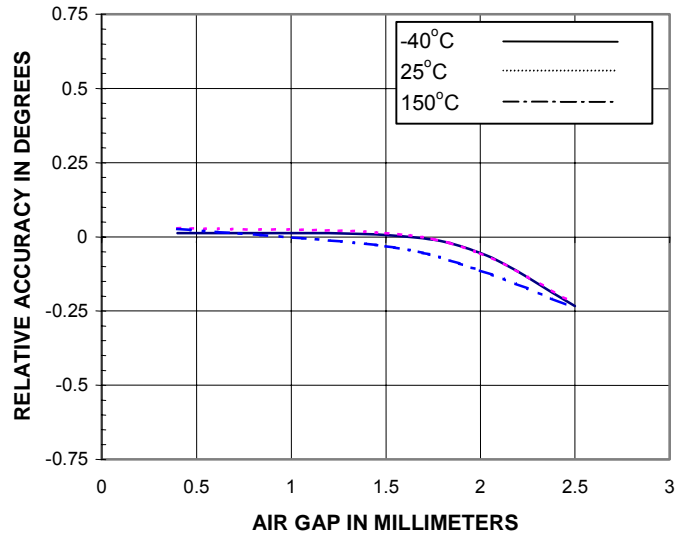

Rising sequential tooth edge 10 RPM

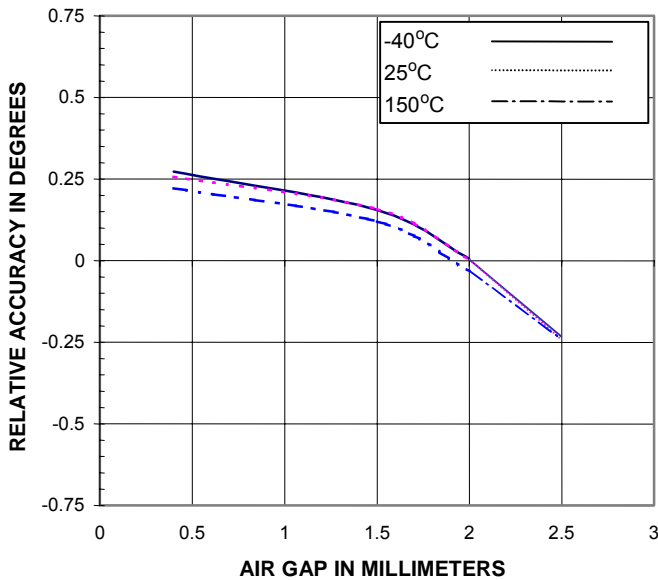

Falling sequential tooth edge 10 RPM

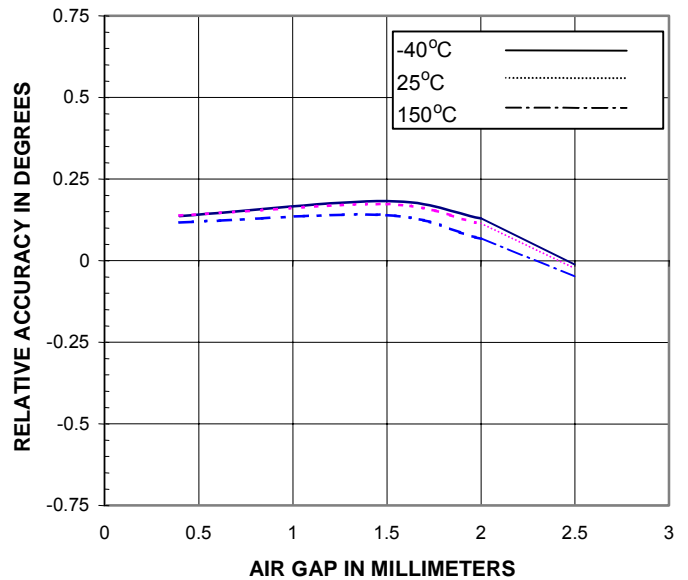

ATS612LSG
 DYNAMIC, SELF-CALIBRATING, PEAK-DETECTING,
 DIFFERENTIAL HALL-EFFECT GEAR TOOTH SENSOR

MECHANICAL INFORMATION

Component	Material	Function	Value
Sensor Package Material	Thermoset Epoxy	Max. Temperature	170°C ¹
Leads	Copper, 0.016" dia, 0.050" spacing		
Lead Coating	Solder, Tin / Lead 90/10 ²		

¹ Temperature excursions of up to 225°C for 2 minutes or less are permitted.

² Industry accepted soldering techniques are acceptable for this module as long as the indicated maximum temperatures for each component are not exceeded. Please see the Allegro website (<http://www.allegromicro.com/techpub2/an/an26009.pdf>) for soldering profile.

ELECTROMAGNETIC CAPABILITY (EMC) PERFORMANCE

Please contact Allegro MicroSystems for EMC performance.

Test Name	Reference Specification
ESD – Human Body Model	AEC-Q100-002
ESD – Machine Model	AEC-Q100-003
Conducted Transients	ISO 7637-1
Direct RF Injection	ISO 11452-7
Bulk Current Injection	ISO 11452-4
TEM Cell	ISO 11452-3

ATS612LSG
 DYNAMIC, SELF-CALIBRATING, PEAK-DETECTING,
 DIFFERENTIAL HALL-EFFECT GEAR TOOTH SENSOR

PACKAGE DRAWING
 For Reference Only

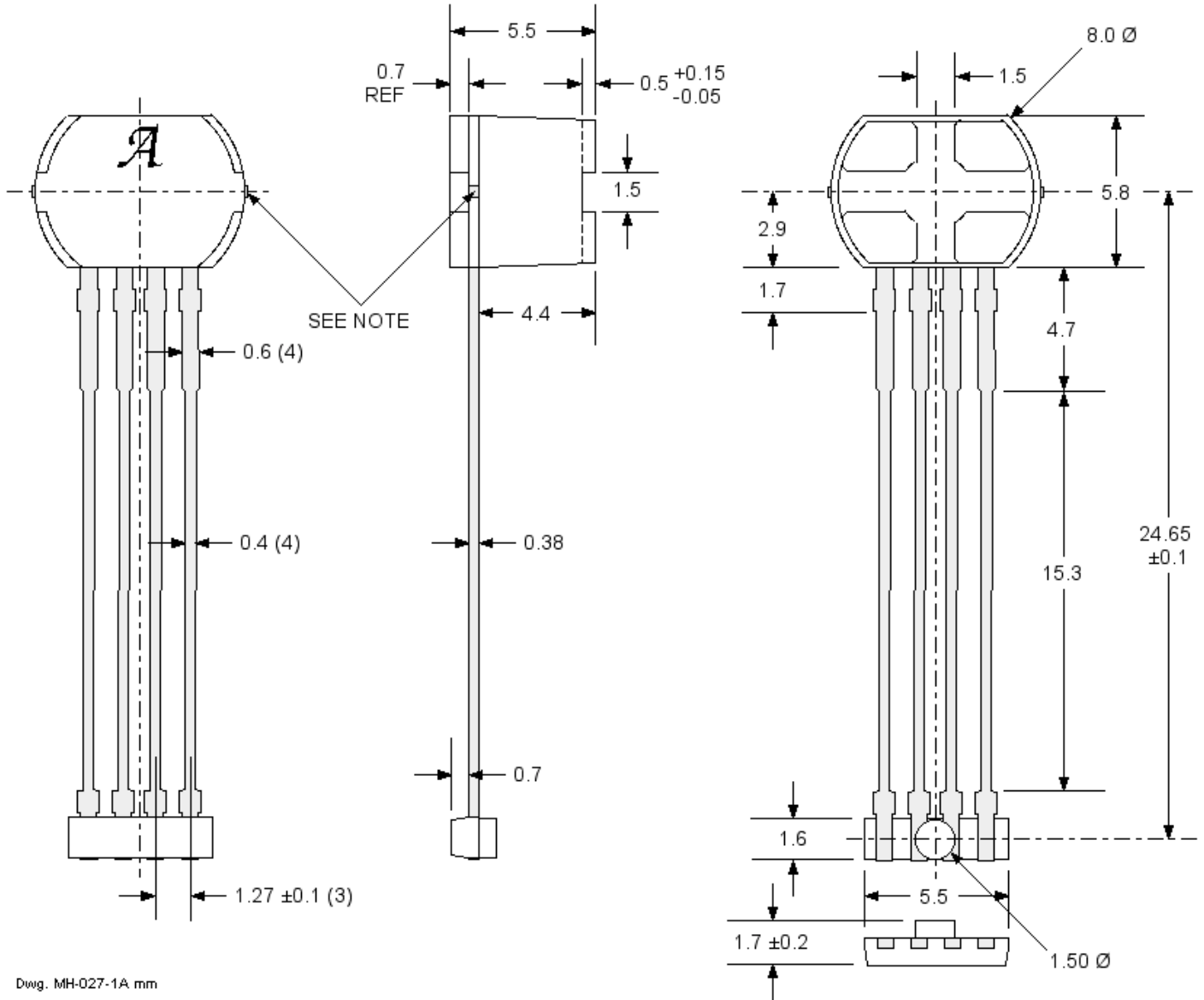

Dwg. MH-027-1A mm

NOTE: Metallic protrusion may be present, electrically connected to substrate and pin 4 (ground).

ATS612LSG
DYNAMIC, SELF-CALIBRATING, PEAK-DETECTING,
DIFFERENTIAL HALL-EFFECT GEAR TOOTH SENSOR

The products described herein are manufactured under one or more of the following U.S. patents: 5,045,920; 5,264,783; 5,442,283; 5,389,889; 5,581,179; 5,517,112; 5,619,137; 5,621,319; 5,650,719; 5,686,894; 5,694,038; 5,719,130; 5,917,320; and other patents pending.

Allegro MicroSystems, Inc. reserves the right to make, from time to time, such departures from the detail specifications as may be required to permit improvements in the design of its products. Before placing an order, the user is cautioned to verify that the information being relied upon is current.

Allegro products are not authorized for use as critical components in life-support applications, devices, or systems without express written approval.

The information included herein is believed to be accurate and reliable. However, Allegro MicroSystems, Inc. assumes no responsibility for its use; nor for any infringements of patents or other rights of third parties which may result from its use.