

**ProLite 5W SMD Star**  
**BTP5-99XXCT-XX-X/W**

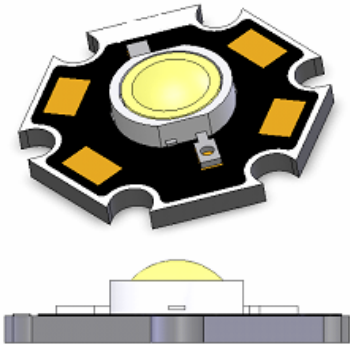

**Package Dimension**

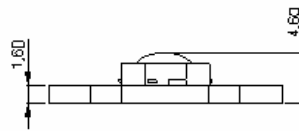
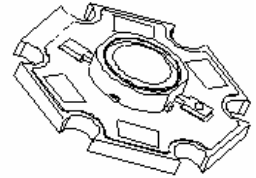
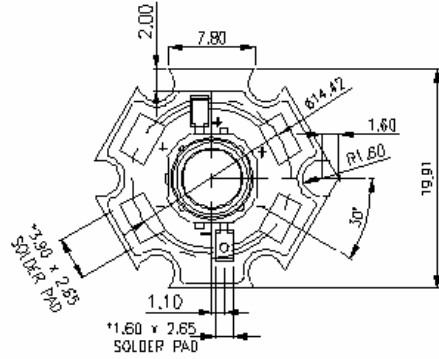

**Features**

- Highest Lumen Per Watt
- Long Operational Life
- White Housing
- Superior ESD Protection
- Instant Light (less than 100ns)
- Compatible to Luxeon's "Lambertian"
- True SMD Emitter
- IR Reflow Soldering Process

Note: Lens is low dome profile

Tolerance: ± see spec      Unit: mm

**Applications**

- Accent Light/Down Light/Spot Light
- Automotive Exterior/Interior Light
- Large Area LCD Backlights
- Marine/Miner's Lighting
- Portable Flashlight/ General Lighting

**Optical Characteristics at T<sub>J</sub>=25°C, I<sub>F</sub>=700mA**

PART NUMBER	Emitting Color	LED Chip Material	Lens Color	Wavelength (nm)		Drive Voltage @ 700mA	Luminous Flux (lm) @700mA	VIEW ANGLE 2θ <sub>1/2</sub> (deg)
				CCT (K) Range				
				Min	Max	Typ.	Typ.	
BTP5-99NRCT-XX-X/W	Normal Red	AlInGaP	Water Clear	620	645	4.40V	120	140
BTP5-99AMCT-XX-X/W	Amber		Water Clear	610	620	4.40V	144	
BTP5-99YECT-XX-X/W	Yellow		Water Clear	585	600	4.40V	112	
BTP5-99BLCT-XX-X/W	Blue	AlInGaN	Water Clear	460	490	7.10V	40	
BTP5-99PGCT-XX-X/W	Green		Water Clear	520	545	7.10V	120	
BTP5-99WWCT-XX-X/W	Warm White		Water Clear	2800K	3800K	7.10V	96	
BTP5-99WHCT-XX-X/W	White		Water Clear	5000K	8000K	7.10V	100	

**Notes:**

- 1) Picture for illustration purpose only. Please refer to outline dimension for actual package size.
- 2) Flux is measured with the accuracy of ±15%. Please refer to Flux Selection Guide
- 3) CCT is measured with the accuracy of ± 400K. Please refer to CCT Selection Guide
- 4) V<sub>F</sub> is measured with the accuracy of ± 0.15V. Please refer to V<sub>F</sub> Selection Guide



**ProLite 5W SMD Star**  
**BTP5-99XXCT-XX-X/W**

**Absolute Maximum Ratings at T<sub>J</sub>=25°C**

Parameter	Red/Amber/Yellow	White/Blue/Green
Power Dissipation (W)	4.35	5.59
DC Forward Current (mA) <sup>[1]</sup>	700	700
Peak Pulsed Forward Current (mA) <sup>[4]</sup>	1000	1000
Average Forward Current (mA)	700	700
Reverse Voltage (V)	5	5
Reverse Current (uA)	50	50
ESD Sensitivity (V) <sup>[2]</sup>	16,000	16,000
LED Junction Temperature at 350mA (°C) <sup>[3]</sup>	120	135
Thermal Resistance Junction to Board (°C/W)	13	13
Temperature Coefficient of V <sub>F</sub> (mV/°C)	-2	-2
Storage Temperature (°C)	-40 to +105	-40 to +105
Operating Temperature (°C)	-40 to +105	-40 to +105
Lead Soldering Temperature (°C) <sup>[4]</sup>	260°C for 5 seconds max	260°C for 5 seconds max

**Application Notes:**

1. Proper forward current must be observed to maintain the junction temperature below maximum rating
2. Although all products listed are class two ESD protection (+/- 16KV by HBM mode), care must be fully taken when handling products
3. Specification is subjected to change for improvements without notice.
4. Test conditions: tp≤10us, duty cycle = 0.005
5. CAUTION: When lighting up, the emitter will become very hot if it is not attached to a heat sink. Please provide proper heat management to prevent damage to the emitter.



**WARNING**

This range of LEDs is produced with die having a high radiant flux. Care must be taken when viewing the product at close range as the light may be intense enough to cause damage to the human eye.

**Note:** Industry standard procedures regarding static must be observed when handling this product.

CCT, Flux and  $V_F$  Selection Guide (@ $T_J=25^\circ\text{C}$ ,  $I_F=700\text{mA}$ )

**BTP5-99XXCT-XX-X/W**

White Housing

**Wavelength Ranks Selection**

Color	Bin	$\lambda_D(\text{nm})$	
		Min	Max
Blue	B5	460	465
	B6	465	470
	B7	470	475
	B8	475	480
	B9	480	485
	B10	485	490
	XX	460 – 490	
Green	G7	520	525
	G8	525	530
	G9	530	535
	G10	535	540
	G11	540	545
	XX	520 – 545	
Red	XX	620 – 630	
Amber	XX	610 – 620	
Yellow	XX	585 – 600	

**Flux Ranks Selection**

Color	Bin	Flux (lumens)
Blue	P	23~30
	Q	30~39
	R	39~50
	X	Default Full Range
Red Amber Yellow Green White	T	65~85
	U	85~111
	V	111~144
	W	144~187
	X	Default Full Range

**CCT Ranks Selection**

Color Temp	Bin	CCT(K)	
		Min	Max
Warm White	00	2800	3300
	01	3300	3800
	XX	2800K – 3800K	
White	02	5000	6000
	03	6000	7000
	04	7000	8000
	XX	5000K – 8000K	

 **$V_F$  Ranks Selection**

Color	Bin	$V_F$ (V)	
		Min	Max
Red Amber Yellow	V12	3.6	3.8
	V13	3.8	4.0
	V14	4.0	4.2
	V15	4.2	4.4
	V16	4.4	4.6
	V17	4.6	4.8
	VXX(Full)	3.6~4.8	
Warm White White Blue Green	V27	6.8	7.0
	V29	7.0	7.2
	V30	7.2	7.4
	V31	7.4	7.6
	V32	7.6	7.8
	V33	7.8	8.0
	VXX(Full)	6.8~8.0	

 (Please specify on order, otherwise, default full range of  $V_F$ )

Typical Electro-Optical Characteristics Curves

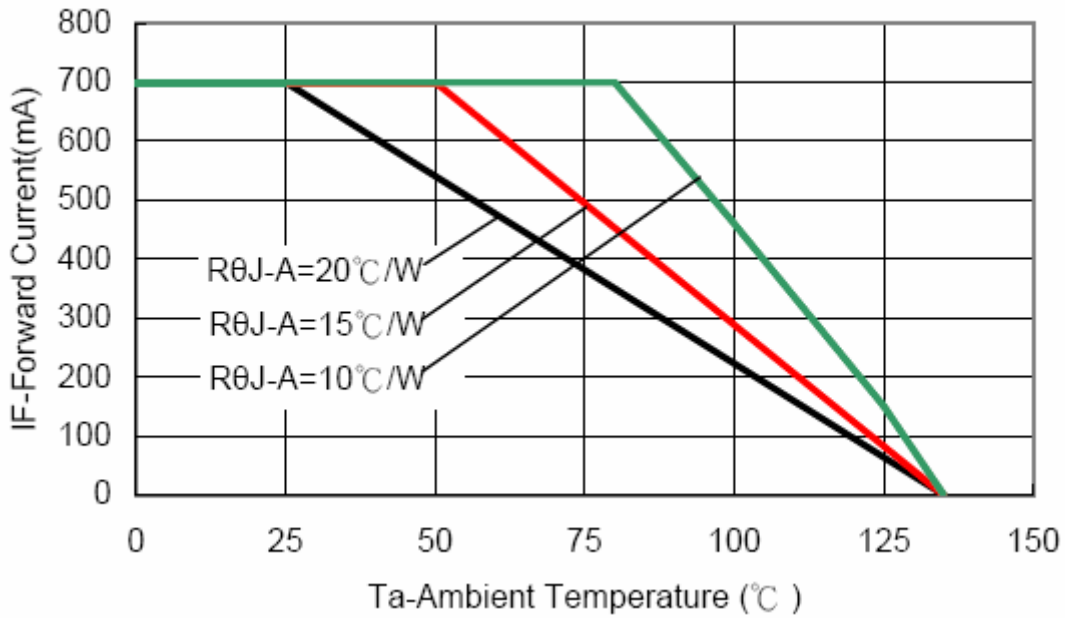

**Fig. 1 Forward Current vs Ambient Temperature (Green, Blue and White)**

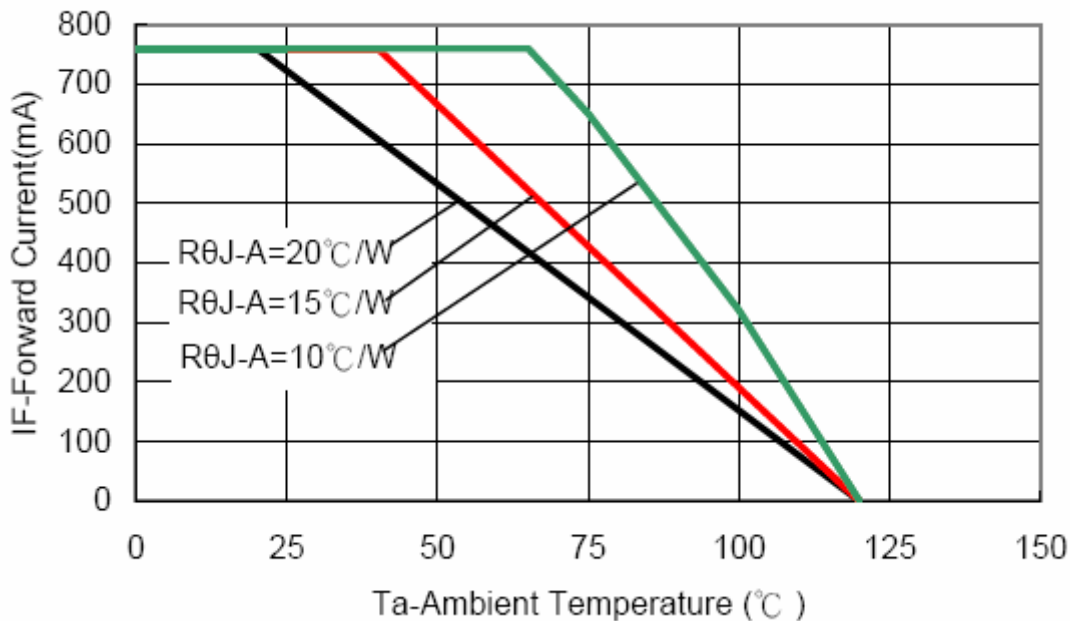

**Fig. 2 Forward Current vs Ambient Temperature (Red, Amber and Yellow)**

**Forward Current Characteristics, Tj=25°C**

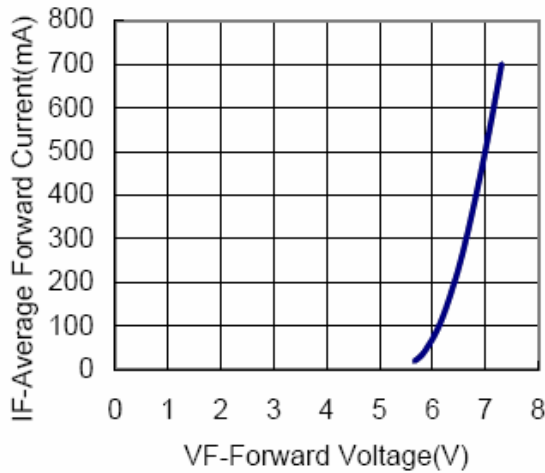

Fig 3a. Forward Current vs. Forward Voltage for White, Warm White, Blue and Green.

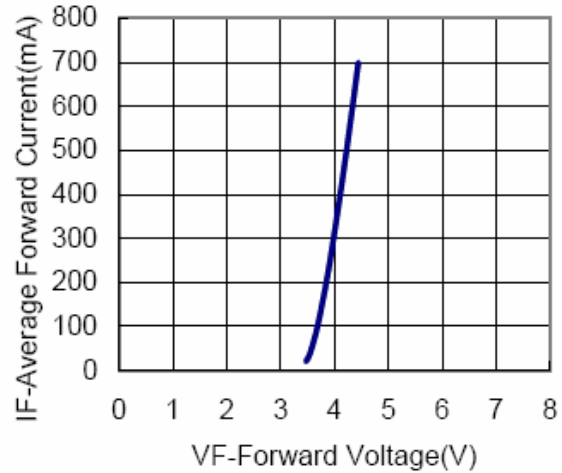

Fig 3b. Forward Current vs. Forward Voltage for Amber, Red-Orange and Red.

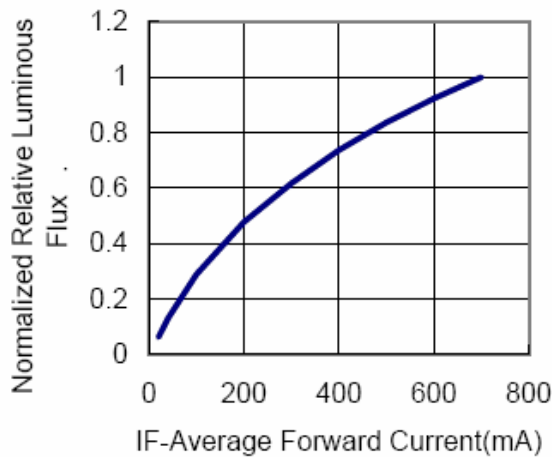

Fig 4a. Relative Luminous Flux vs. Forward Current for White, Warm White, Blue and Green at Tj=25°C maintained.

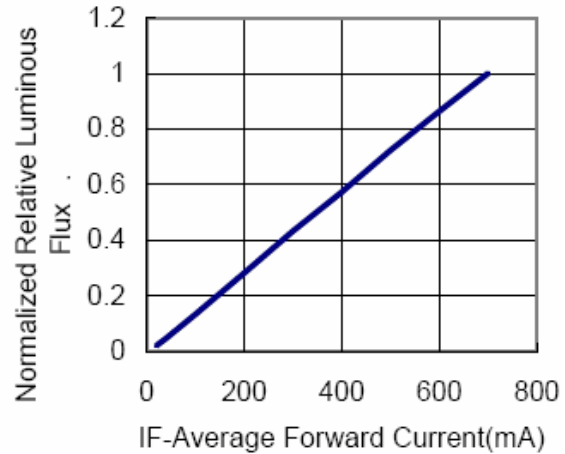
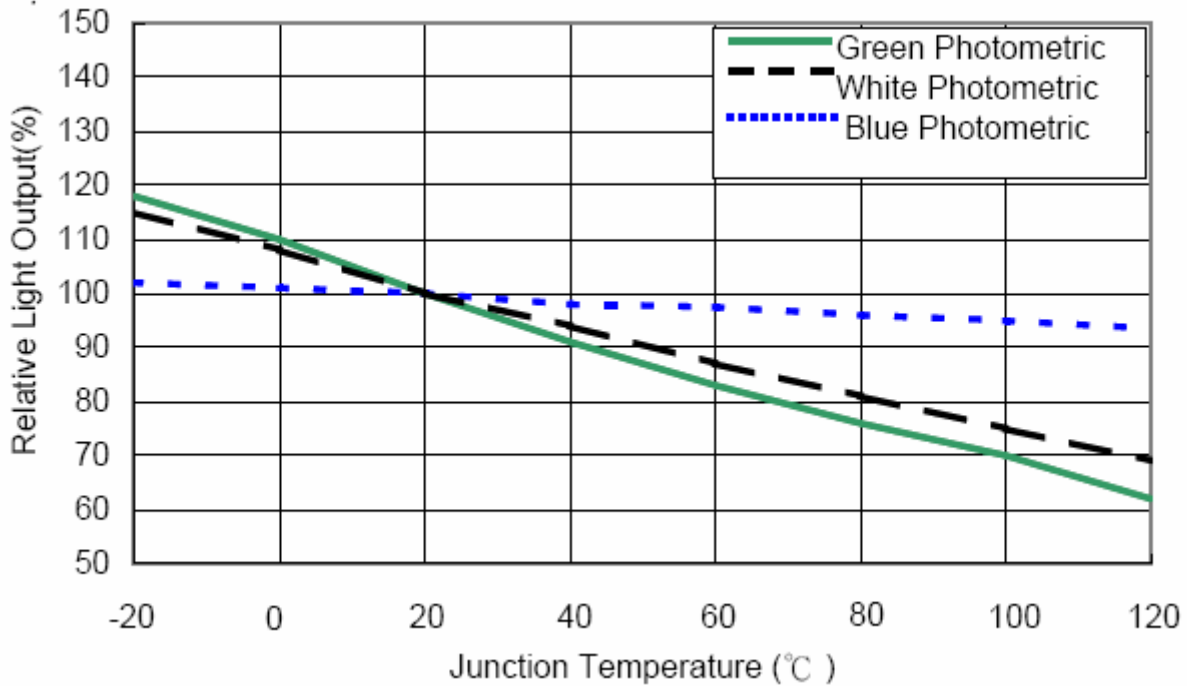
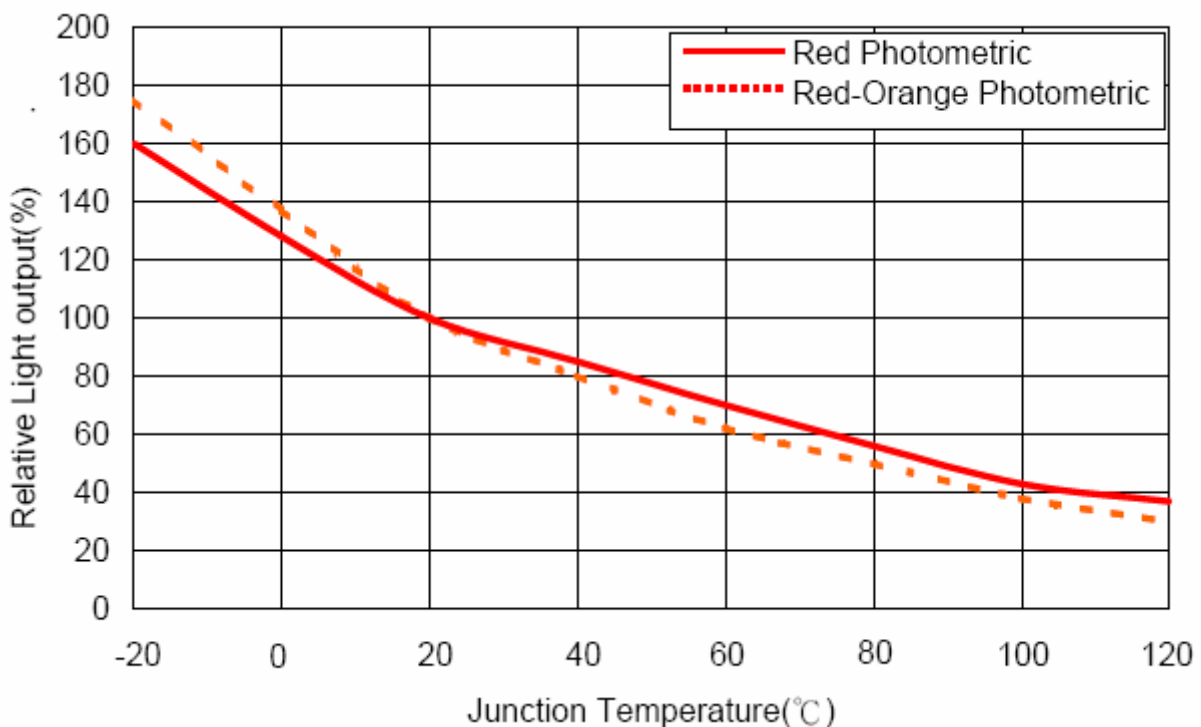

Fig 4b. Relative Luminous Flux vs. Forward Current for Amber, Red-Orange, Red at Tj=25°C maintained.

Typical Electro-Optical Characteristics Curves

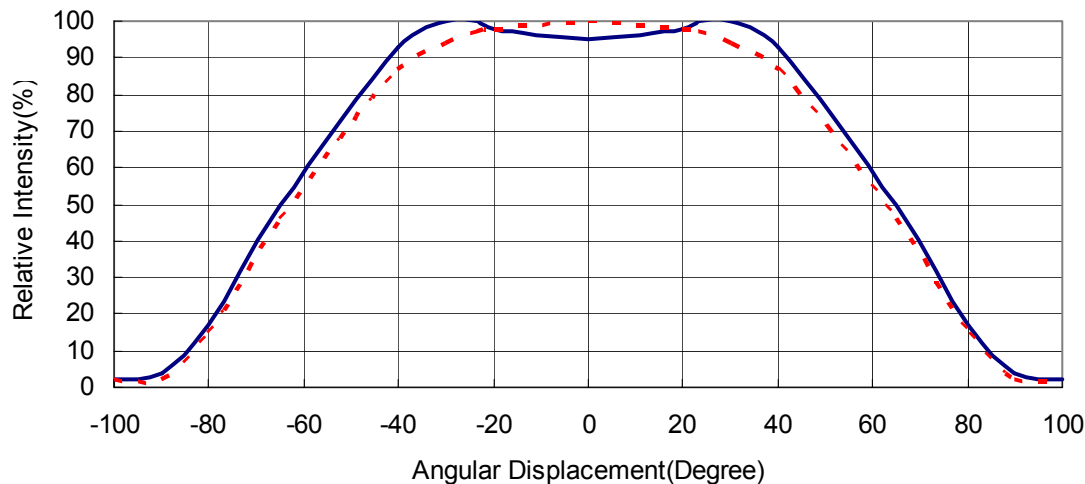

**Fig. 5a Relative Light Output vs Junction Temperature**



**Fig. 5b Relative Light Output vs Junction Temperature**

## Typical Electro-Optical Characteristics Curves



**Fig. 6 Typical Radiation Pattern**

## Other Important Notes

- The information contained herein is presented only as a Guide for the application of our products. Brilliance Technologies assumes no responsibility for any infringement of intellectual property or other rights of the third parties which may result from its use.
- Brilliance Technologies continually improves the quality of our products. Nevertheless, semiconductor devices in general can malfunction or fail due to their inherent electrical sensitivity and vulnerability to physical stress. It is the responsible of the customer, when using Brilliance Technologies products, to comply with the standard of safety in making a safe design for the entire system, and to avoid situations in which a malfunction or failure of such Brilliance Technologies products cause loss of human life, bodily injury or damage to property.
- Brilliance Technologies products listed in this data sheet are intended for usage in general electronics and/or non-commercial or industrial lighting products. These products are neither intended nor warranted for usage in equipment that requires extraordinarily high quality and/or reliability or a malfunction or failure of which may cause loss of human life or bodily injury.
- In developing your design, please ensure that Brilliance Technologies products are used within specified operating ranges as set forth in the most recent Brilliance Technologies data sheets.

BT-Rev. 1.0B20050120  
Specifications are subject to change for improvement without notice.  
Copyright © 2003 Brilliance Technologies Co., Ltd. All rights reserved.