

BSP 317

SIPMOS® Small-Signal Transistor

- P channel
- Enhancement mode
- Logic Level
- $V_{GS(th)} = -0.8 \dots -2.0 \text{ V}$

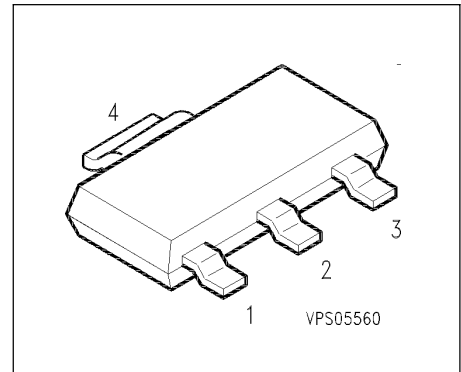

Pin 1	Pin 2	Pin 3	Pin 4
G	D	S	D

Type	V_{DS}	I_D	$R_{DS(on)}$	Package	Marking
BSP 317	-200 V	-0.37 A	6 Ω	SOT-223	

Type	Ordering Code	Tape and Reel Information
BSP 317	Q67000-S94	E6327

Maximum Ratings

Parameter	Symbol	Values	Unit
Drain source voltage	V_{DS}	-200	V
Drain-gate voltage	V_{DGR}	-200	
$R_{GS} = 20 \text{ k}\Omega$			
Gate source voltage	V_{GS}	± 20	
Continuous drain current	I_D	-0.37	A
$T_A = 25 \text{ }^\circ\text{C}$			
DC drain current, pulsed	I_{Dpuls}	-1.48	
$T_A = 25 \text{ }^\circ\text{C}$			
Power dissipation	P_{tot}	1.8	W
$T_A = 25 \text{ }^\circ\text{C}$			

Maximum Ratings

Parameter	Symbol	Values	Unit
Chip or operating temperature	T_j	-55 ... + 150	°C
Storage temperature	T_{stg}	-55 ... + 150	
Thermal resistance, chip to ambient air	R_{thJA}	≤ 70	K/W
Thermal resistance, junction-soldering point ¹⁾	R_{thJS}	≤ 10	
DIN humidity category, DIN 40 040		E	
IEC climatic category, DIN IEC 68-1		55 / 150 / 56	

1) Transistor on epoxy pcb 40 mm x 40 mm x 1,5 mm with 6 cm² copper area for drain connection

Electrical Characteristics, at $T_j = 25^\circ\text{C}$, unless otherwise specified

Parameter	Symbol	Values			Unit
		min.	typ.	max.	

Static Characteristics

Drain- source breakdown voltage $V_{GS} = 0\text{ V}, I_D = -0.25\text{ mA}, T_j = 25^\circ\text{C}$	$V_{(BR)DSS}$	-200	-	-	V
Gate threshold voltage $V_{GS} = V_{DS}, I_D = -1\text{ mA}$	$V_{GS(th)}$	-0.8	-1.1	-2	
Zero gate voltage drain current $V_{DS} = -200\text{ V}, V_{GS} = 0\text{ V}, T_j = 25^\circ\text{C}$	I_{DSS}	-	-0.1	-1	μA
$V_{DS} = -200\text{ V}, V_{GS} = 0\text{ V}, T_j = 125^\circ\text{C}$		-	-10	-100	
$V_{DS} = -130\text{ V}, V_{GS} = 0\text{ V}, T_j = 25^\circ\text{C}$		-	-	-100	nA
Gate-source leakage current $V_{GS} = -20\text{ V}, V_{DS} = 0\text{ V}$	I_{GSS}	-	-10	-100	nA
Drain-Source on-state resistance $V_{GS} = -10\text{ V}, I_D = -0.37\text{ A}$	$R_{DS(on)}$	-	3.4	6	Ω

Electrical Characteristics, at $T_j = 25^\circ\text{C}$, unless otherwise specified

Parameter	Symbol	Values			Unit
		min.	typ.	max.	
Dynamic Characteristics					
Transconductance $V_{DS} \geq 2 * I_D * R_{DS(on)max}$, $I_D = -0.37\text{ A}$	g_{fs}	0.25	0.35	-	S
Input capacitance $V_{GS} = 0\text{ V}$, $V_{DS} = 25\text{ V}$, $f = 1\text{ MHz}$	C_{iss}	-	270	360	pF
Output capacitance $V_{GS} = 0\text{ V}$, $V_{DS} = 25\text{ V}$, $f = 1\text{ MHz}$	C_{oss}	-	50	75	
Reverse transfer capacitance $V_{GS} = 0\text{ V}$, $V_{DS} = 25\text{ V}$, $f = 1\text{ MHz}$	C_{rss}	-	15	25	
Turn-on delay time $V_{DD} = -30\text{ V}$, $V_{GS} = -10\text{ V}$, $I_D = -0.29\text{ A}$ $R_{GS} = 50\ \Omega$	$t_{d(on)}$	-	8	12	ns
Rise time $V_{DD} = -30\text{ V}$, $V_{GS} = -10\text{ V}$, $I_D = -0.29\text{ A}$ $R_{GS} = 50\ \Omega$	t_r	-	30	45	
Turn-off delay time $V_{DD} = -30\text{ V}$, $V_{GS} = -10\text{ V}$, $I_D = -0.29\text{ A}$ $R_{GS} = 50\ \Omega$	$t_{d(off)}$	-	80	110	
Fall time $V_{DD} = -30\text{ V}$, $V_{GS} = -10\text{ V}$, $I_D = -0.29\text{ A}$ $R_{GS} = 50\ \Omega$	t_f	-	90	120	

Electrical Characteristics, at $T_j = 25^\circ\text{C}$, unless otherwise specified

Parameter	Symbol	Values			Unit
		min.	typ.	max.	

Reverse Diode

Inverse diode continuous forward current $T_A = 25^\circ\text{C}$	I_S	-	-	-0.37	A
Inverse diode direct current,pulsed $T_A = 25^\circ\text{C}$	I_{SM}	-	-	-1.48	
Inverse diode forward voltage $V_{GS} = 0\text{ V}, I_F = -0.74\text{ A}, T_j = 25^\circ\text{C}$	V_{SD}	-	-0.95	-1.1	V

Power dissipation

$P_{tot} = f(T_A)$

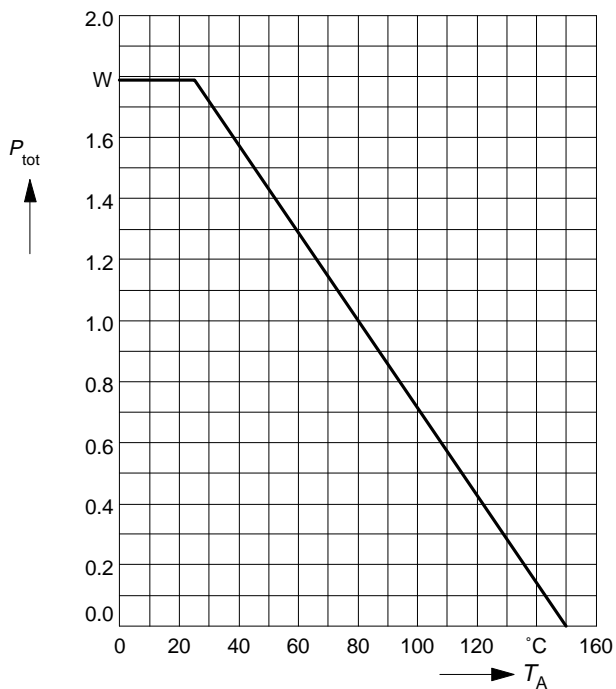

Drain current

$I_D = f(T_A)$

parameter: $V_{GS} \geq -10 \text{ V}$

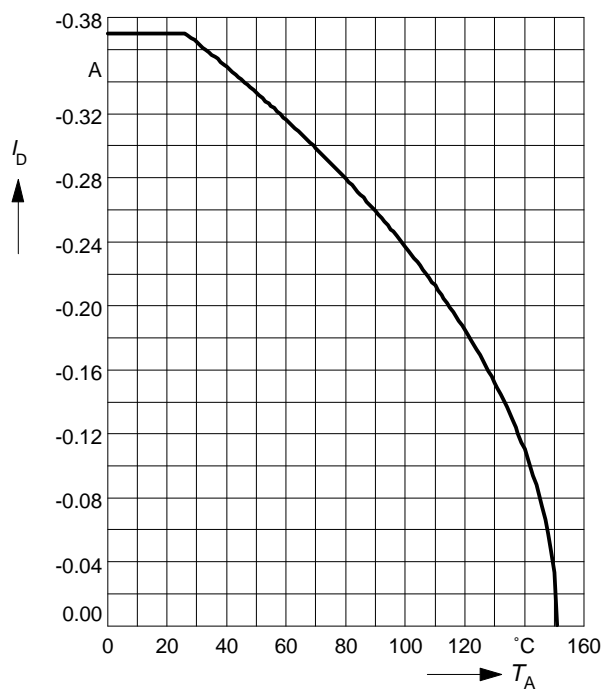

Safe operating area $I_D = f(V_{DS})$

parameter : $D = 0, T_C = 25^\circ\text{C}$

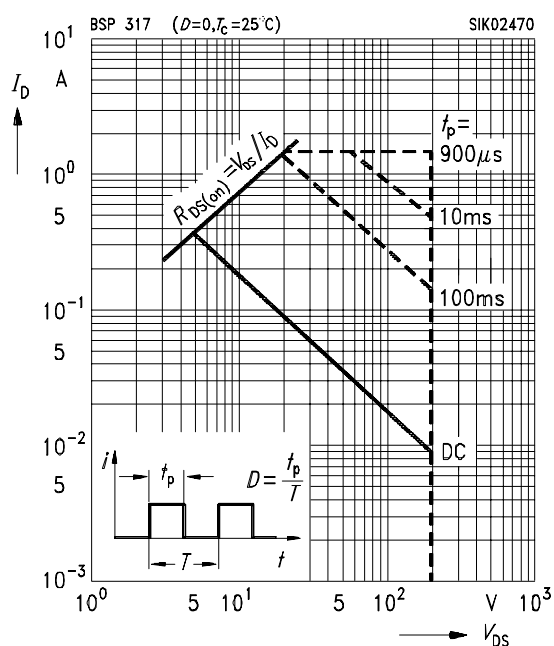

Transient thermal impedance

$Z_{thJA} = f(t_p)$

parameter: $D = t_p / T$

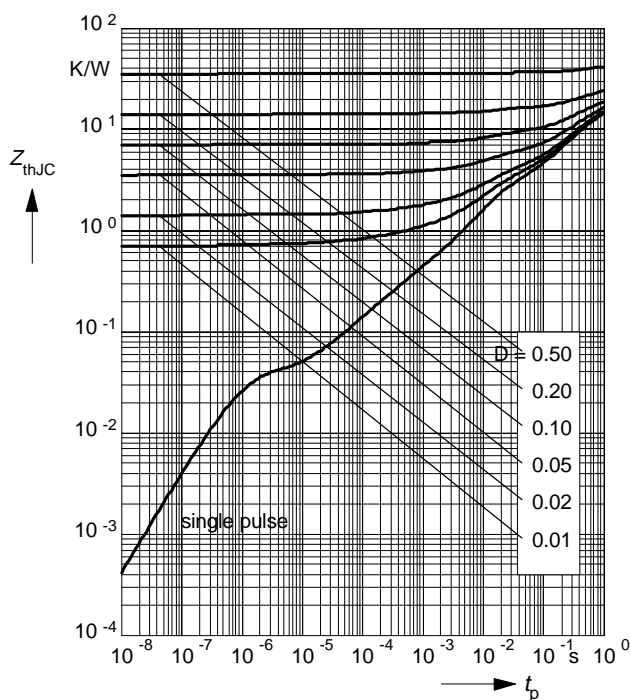

Typ. output characteristics

$$I_D = f(V_{DS})$$

parameter: $t_p = 80 \mu s$

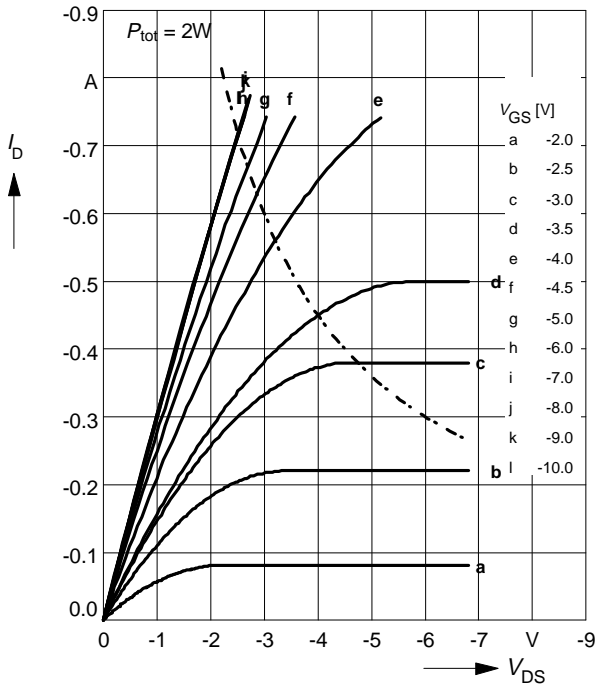

Typ. drain-source on-resistance

$$R_{DS(on)} = f(I_D)$$

parameter: $t_p = 80 \mu s, T_j = 25 \text{ }^\circ C$

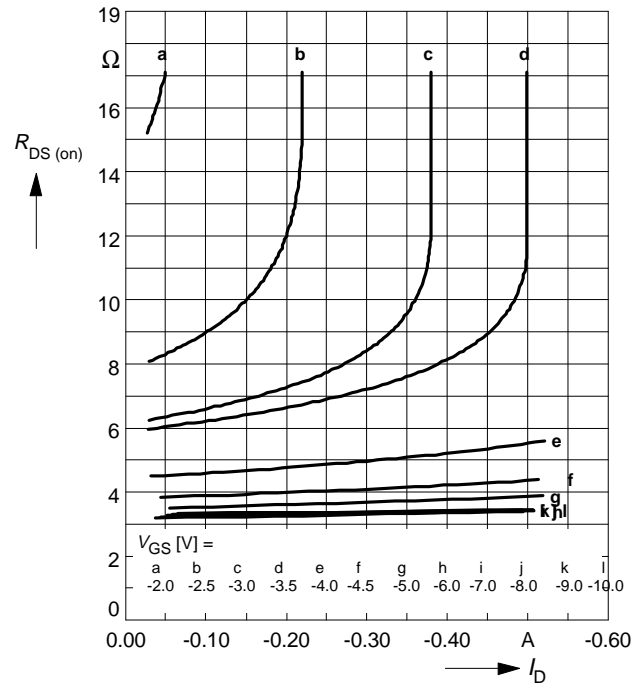

Typ. transfer characteristics $I_D = f(V_{GS})$

parameter: $t_p = 80 \mu s$

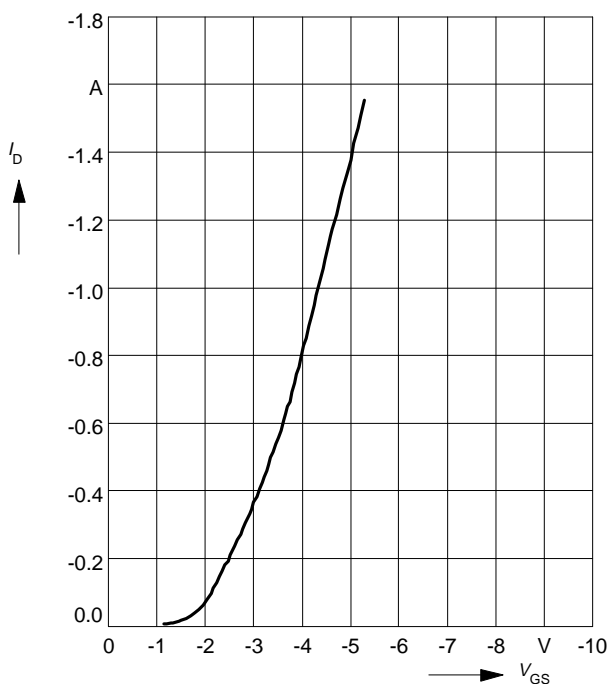

Typ. forward transconductance $g_{fs} = f(I_D)$

parameter: $t_p = 80 \mu s,$

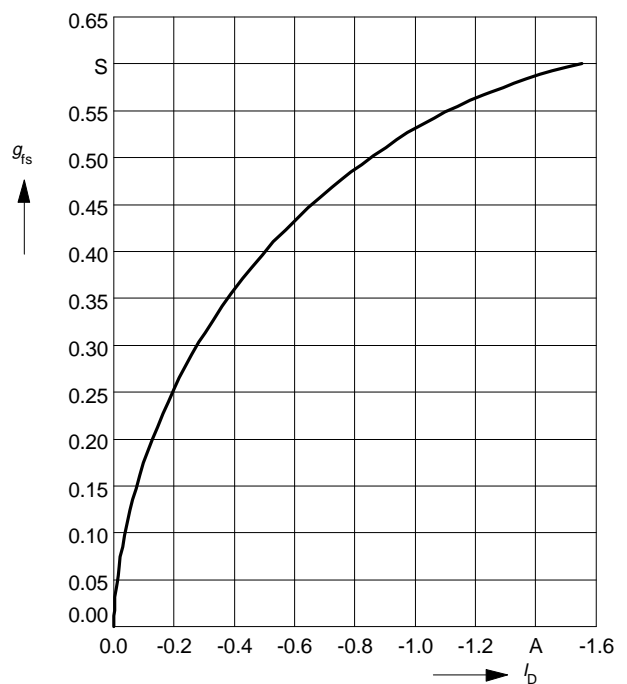

Drain-source on-resistance

$$R_{DS(on)} = f(T_j)$$

parameter: $I_D = -0.37\text{ A}$, $V_{GS} = -10\text{ V}$

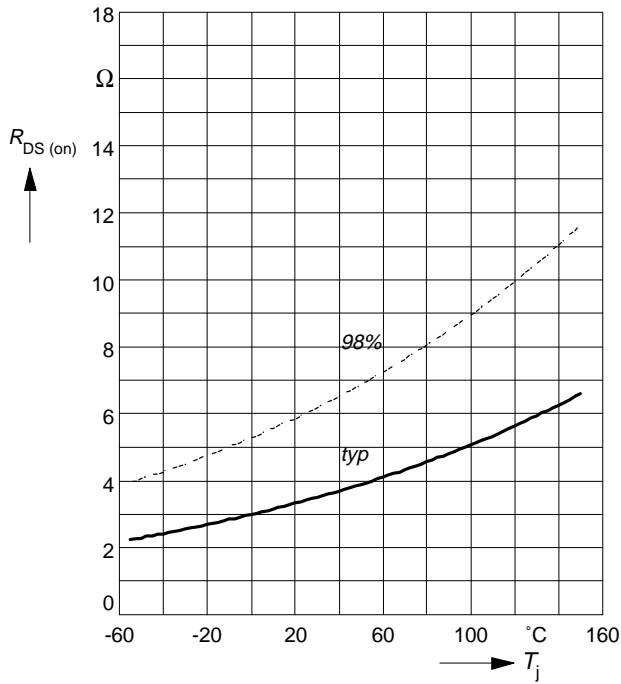

Gate threshold voltage

$$V_{GS(th)} = f(T_j)$$

parameter: $V_{GS} = V_{DS}$, $I_D = -1\text{ mA}$

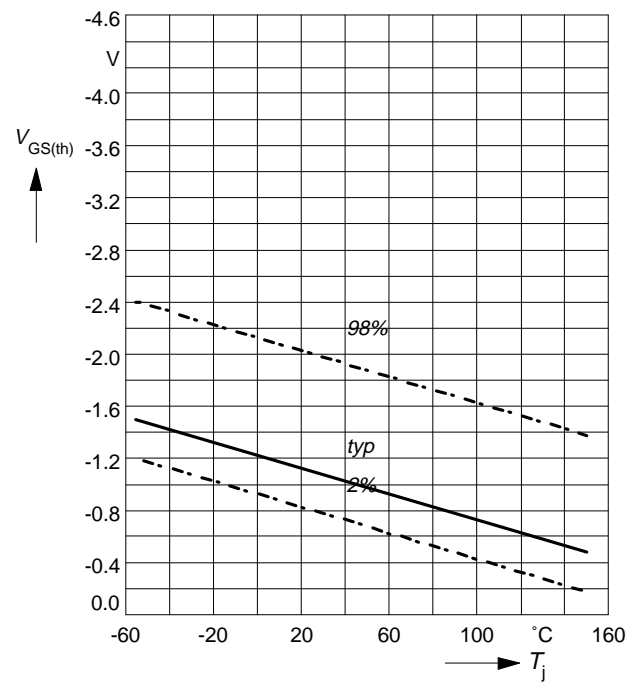

Typ. capacitances

$$C = f(V_{DS})$$

parameter: $V_{GS} = 0\text{ V}$, $f = 1\text{ MHz}$

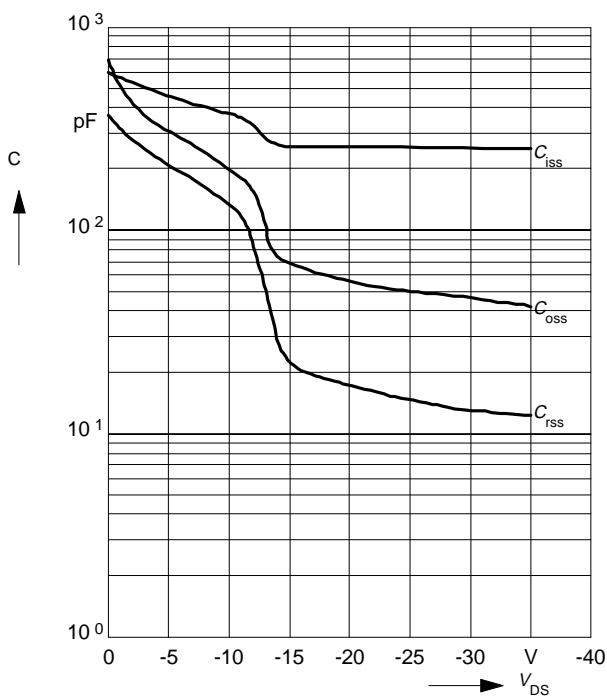

Forward characteristics of reverse diode

$$I_F = f(V_{SD})$$

parameter: $T_j, t_p = 80\text{ }\mu\text{s}$

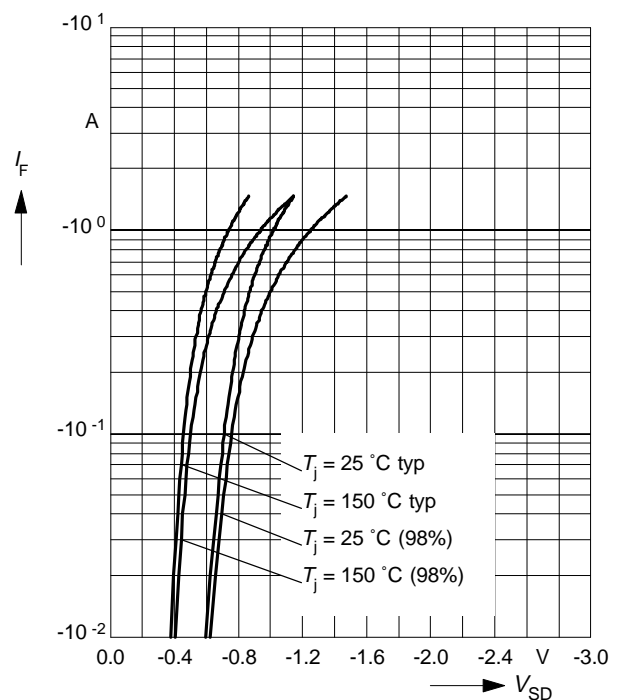

Drain-source breakdown voltage

$$V_{(BR)DSS} = f(T_j)$$

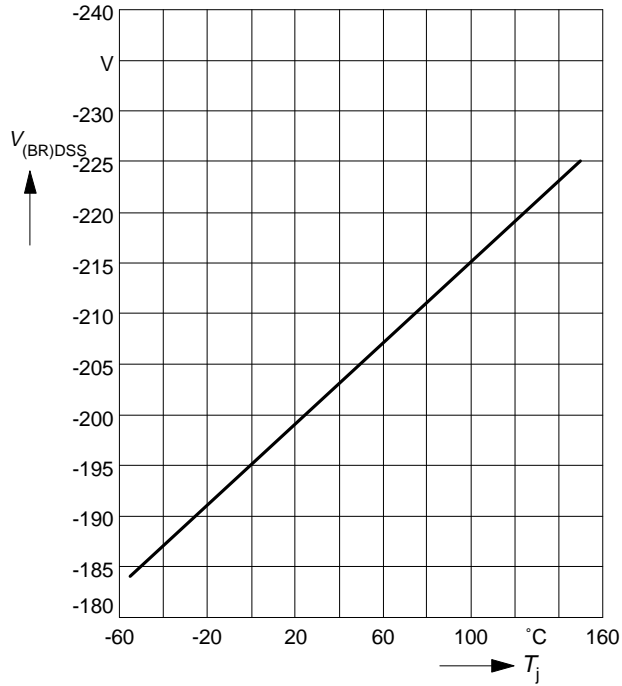

Safe operating area $I_D=f(V_{DS})$

parameter : $D = 0.01, T_C=25^\circ\text{C}$

