

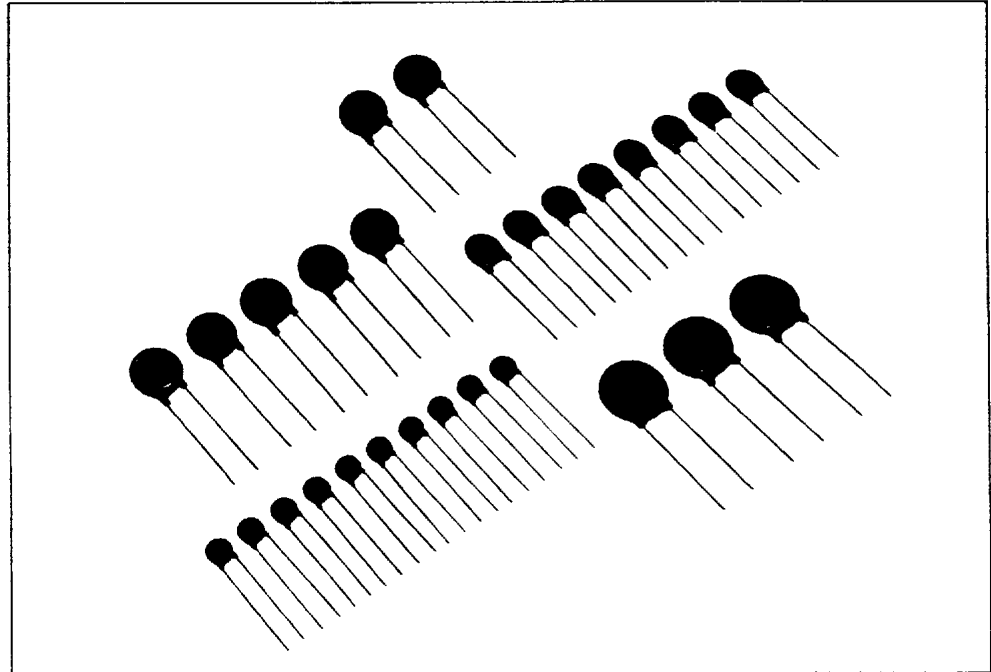

METAL OXIDE VARISTOR

ZENAMIC



ZENAMIC is the product name of a metal oxide varistor.

Features

- High energy absorption
- Excellent voltage clamping characteristics
- Symmetrical characteristics — for use on AC or DC
- Fast response
- Compact and robust construction
- Low idle power
- High surge current capability
- Specific types for PACE/paks and Solid State Relays

Applications

- For protection of all types of semiconductors
- Suppression of switching transients
- Voltage clipping, and circuit damping
- Absorption of surge voltages associated with lightning strikes
- Prolongation of contact life
- Protection in industrial switching circuits

Zenamic voltage suppressors are metal oxide varistors having a non-linear current-voltage characteristic which exhibits an almost constant voltage over a wide range of current. They are ideally suited to all transient voltage protection applications and their high clamping ratios and low steady state power consumption offer considerable circuit advantages over more traditional methods of protection.

Normally the Zenamic idles at a low current level at the nominal voltage. When a transient over-voltage occurs in the circuit, the Zenamic current increases rapidly, its voltage remaining virtually constant. The transient energy is thus absorbed by the Zenamic and the associated circuit impedances.

V-I characteristics

ZENAMIC has the forward-reverse symmetrical electrical characteristics as shown in the figure 1. The voltage-current curves show the varistor characteristics in the range 1 μ A to 10⁴ A, and show the resistance characteristics for the range under 1 μ A and over 10⁴ A in the figure 2. The voltage across terminals when test current (It: 1 mA) is applied to ZENAMIC is a standard varistor voltage (Vz), and the voltage across terminals when a standard surge (Ip) is applied represents the maximum suppression voltage (Vc).

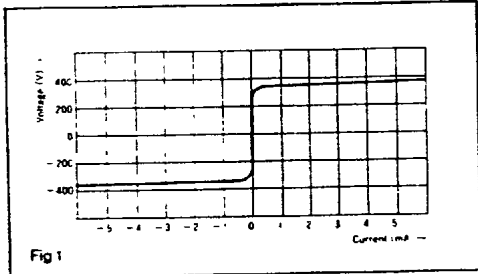

Power derating

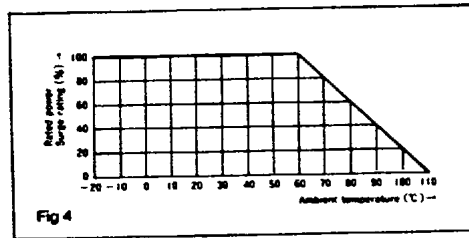

Surge waveform

A surge waveform varies according to the sources. An EXP waveform is used for surge testing of ZENAMIC, while a AC half-wave is used for the energy absorption test. The EXP waveform reaches its peak voltage (current) at [ta] as shown in the figure 5, and then decreases as time passes and reaches half of the peak voltage (current) at [tb]. This type of the EXP waveform is shown as a [ta/tb] voltage (current) waveform. For surge testing of ZENAMIC, the 8/20 μ sec current waveform is used.

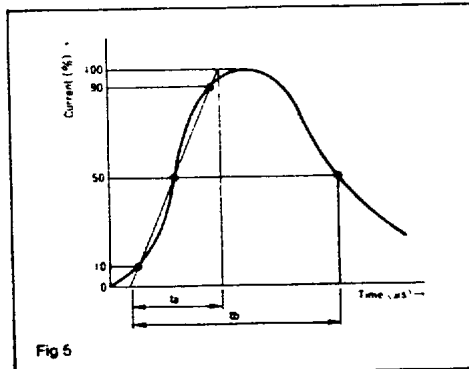

Application

A few examples show. Power lines and surge absorption units with error display (SA series).

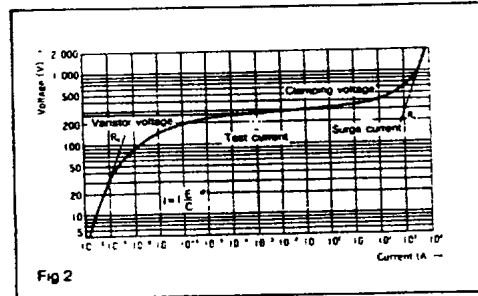
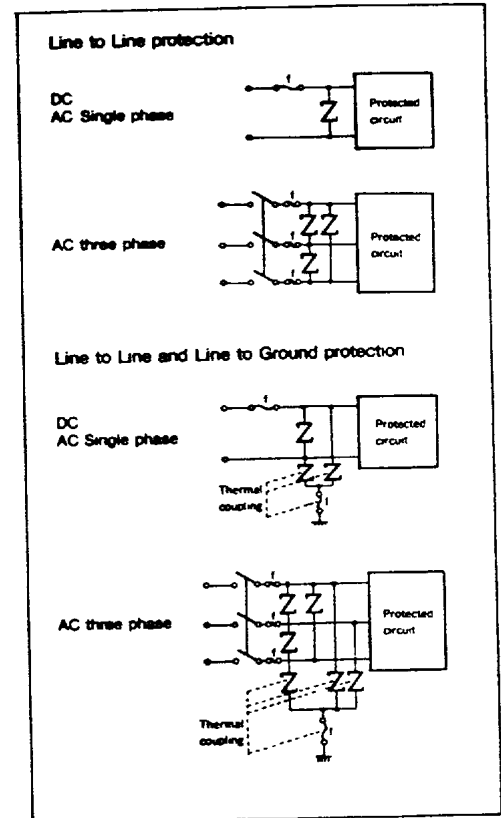

Temperature Characteristics

In the small current range, Zenamic features outstanding temperature characteristics. A shunt resistance Rp of metal oxide varistor has the temperature characteristics which is determined by the following equation.

$$R_p = A e^{E_g/2kT} \quad (2)$$

T: Absolute temperature
k: Boltzmann constant
A, E_g: constants

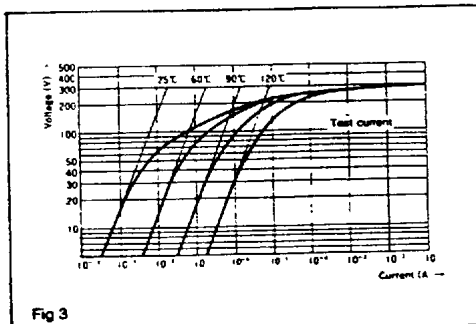

As shown in the figure 3, the temperature dependence characteristics are shown clearly in the low current area.

Type No.

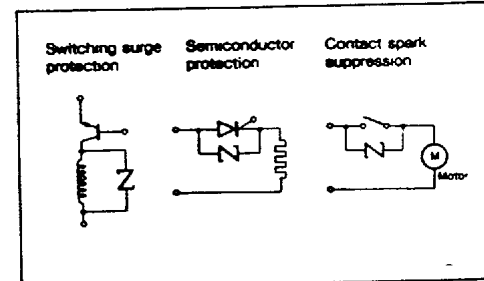
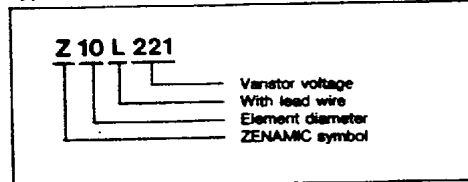

Z7L Series

Specifications

Type No.	Varistor voltage V_{Vrms} (V)		Maximum allowable voltage		Maximum clamping voltage	Rated wattage	Energy (2ms)	Withstanding Surge current (8/20 μ s)		Typical capacitance (@ 1kHz)
	Min	Max	AC	DC				1 Time	2 Times	
			V_{rms}	V	V	W	J			
Z7L180	18 (16~20)		11	14	36 at 2.5A		0.8			3,500
Z7L220	22 (20~24)		14	18	43		0.9			2,800
Z7L270	27 (24~30)		17	22	53		1.0			2,000
Z7L330	33 (30~36)		20	26	65		1.2			1,500
Z7L390	39 (35~43)		25	31	77	0.02	1.5	250A	125A	1,350
Z7L470	47 (42~52)		30	38	93		1.8			1,150
Z7L560	56 (50~62)		35	45	110		2.2			960
Z7L680	68 (61~75)		40	56	135		2.5			700
Z7L820	82 (74~90)		50	65	135 at 10A		3.5			550
Z7L101	100 (90~110)		60	85	165		4.0			500
Z7L121	120 (108~132)		75	100	200		5.0			450
Z7L151	150 (135~165)		95	125	250		6.0			350
Z7L181	180 (162~198)		110	145	300		8.0			300
* Z7L201	200 (185~225)		130	170	340		10.0			250
* Z7L221	220 (198~242)		140	180	360		10.0	1200A	600A	250
* Z7L271	270 (247~303)		175	225	455	0.25	12.0			170
* Z7L331	330 (297~363)		210	275	550		15.0			150
* Z7L361	360 (324~396)		230	300	595		15.0			130
* Z7L391	390 (351~429)		250	320	650		17.0			130
* Z7L431	430 (387~473)		275	350	710		20.0			110
* Z7L471	470 (423~517)		300	385	775		20.0			100

V-I characteristics

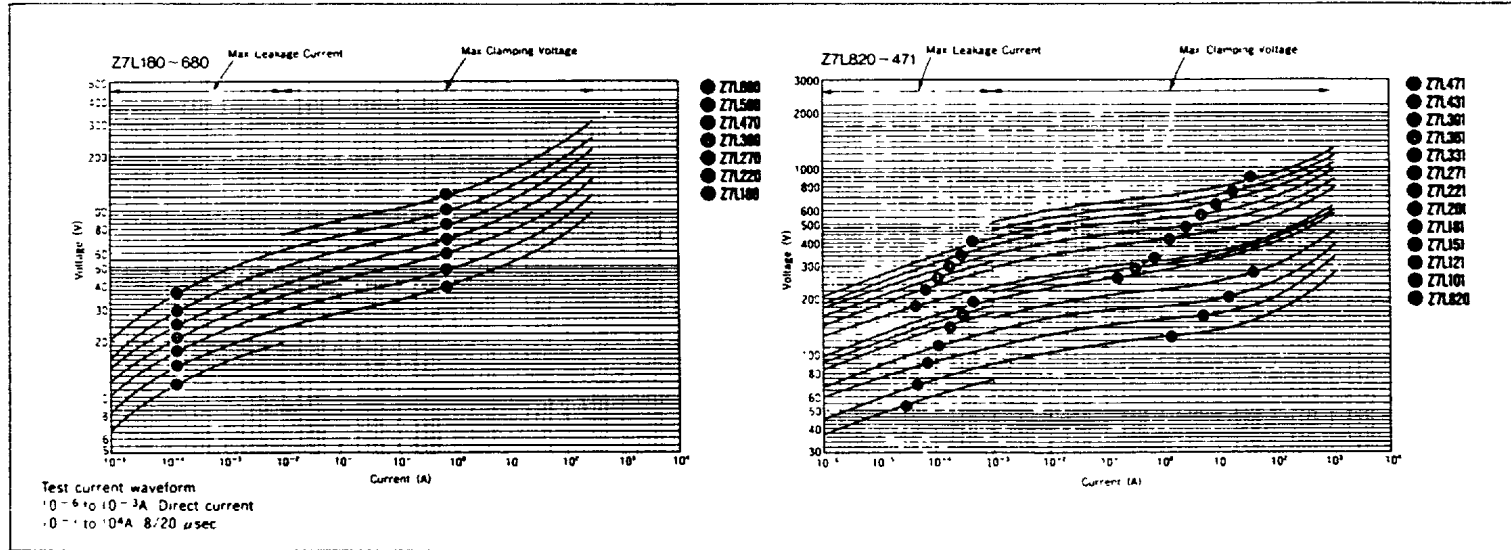

Surge Life Time Ratings (Relation between impulse width and surge repetition time)

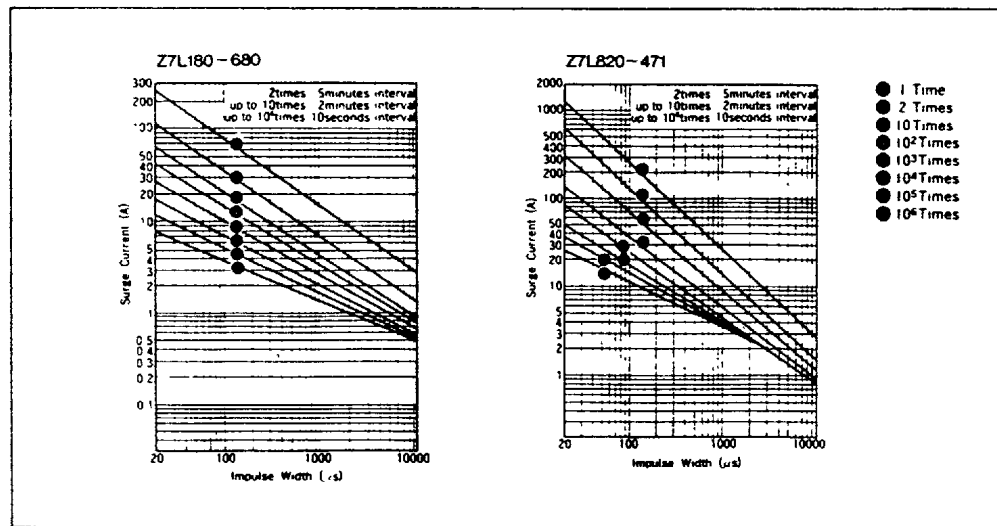

- 1 Operating temperature range -40 to 85 °C
- 2 Storage temperature range -40 to 125 °C
- 3 * UL approved model

Z10L Series

Specifications

Type No.	Varistor voltage V_{1mA} (V)		Maximum allowable voltage		Maximum clamping voltage	Rated wattage	Energy (Jms)	Withstanding Surge Current (8/20 μ s)		Typical capacitance (@ 1kHz)
			AC	DC				1 Time	2 Times	
	Min	Max	Vrms	V	V	W	J			pF
Z10L180	18 (16~20)		11	14	36 at 5A	0.05	1.5	500A	250A	7,500
Z10L220	22 (20~24)		14	18	43		2.0			6,000
Z10L270	27 (24~30)		17	22	53		2.5			4,000
Z10L330	33 (30~36)		20	26	65		3.0			3,000
Z10L390	39 (35~43)		25	31	77		3.5			2,600
Z10L470	47 (42~52)		30	38	93		4.5			2,200
Z10L560	56 (50~62)		35	45	110		5.5			1,800
Z10L680	68 (61~75)		40	56	135		6.5			1,300
Z10L820	82 (74~90)		50	65	135 at 25A	0.4	8	2500A	1250A	1,800
Z10L101	100 (90~110)		60	85	165		10			1,400
Z10L121	120 (108~132)		75	100	200		12			1,100
Z10L151	150 (135~165)		95	125	250		16			900
Z10L181	180 (162~198)		110	145	300		18			700
*Z10L201	200 (185~225)		130	170	340		20			500
*Z10L221	220 (198~242)		140	180	350		23			450
*Z10L271	270 (247~303)		175	225	455		30			350
*Z10L331	330 (297~363)		210	275	650		33			330
*Z10L361	360 (324~396)		230	300	650		36			300
*Z10L381	390 (351~429)		250	320	565		40			270
*Z10L431	430 (387~473)		275	350	710		45			250
*Z10L471	470 (423~517)		300	385	775		45			230
*Z10L561	560 (504~616)		350	460	925		45			150
*Z10L681	680 (612~748)		420	560	1,120		45			130
*Z10L751	750 (675~825)		460	615	1,240		50			120
*Z10L821	820 (738~902)		510	670	1,355		55			110
*Z10L911	910 (819~1,001)		550	745	1,500		60			100
*Z10L102	1,000 (900~1,100)		625	825	1,650	65	90			

V-I characteristics

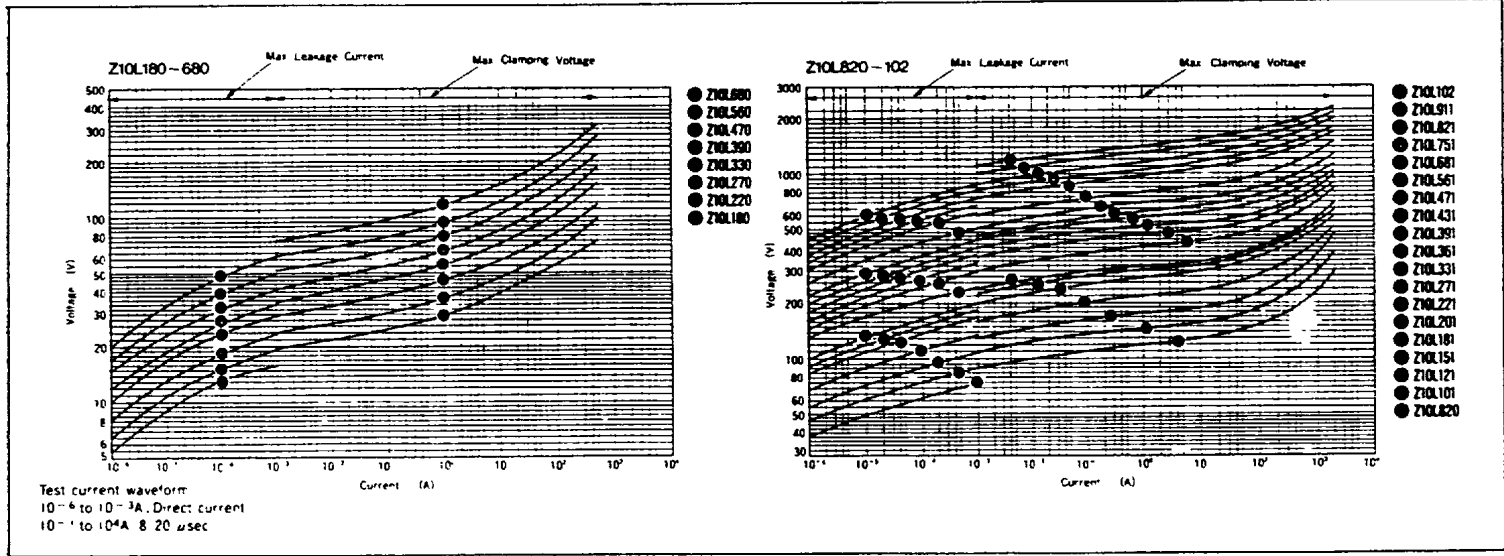

Surge Life Time Ratings (Relation between impulse width and surge repetition time)

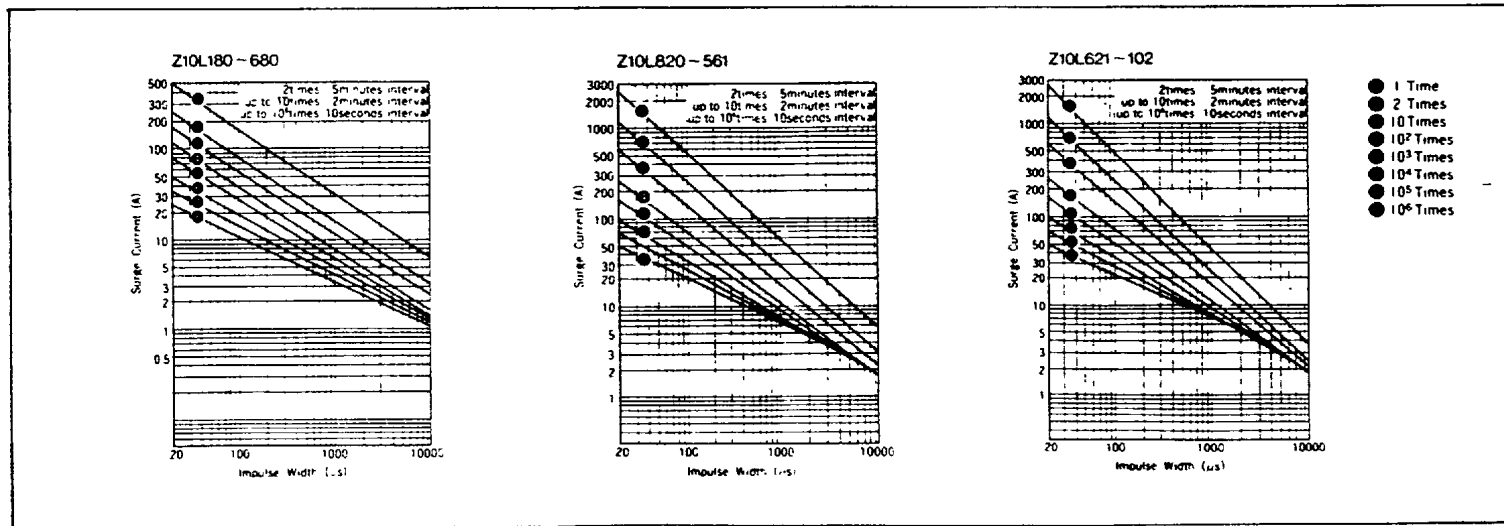

1. Operating temperature range -40 to 85 °C
2. Storage temperature range -40 to 125 °C
3. * : UL approved model

Z15L Series

Specifications

Type No.	Varistor voltage V_{1mA} (V)		Maximum allowable voltage		Maximum clamping voltage V	Rated wattage W	Energy (2ms) J	Withstanding Surge current (8/20 μ s)		Typical capacitance (@ 1kHz) pF
			AC	DC				1 Time	2 Times	
	Vrms	V								
Z15L180	18 (16~20)	11	14	36 at 10A	0.1	3.5	4.0	1000A	500A	18,000
Z15L220	22 (20~24)	14	18	43						
Z15L270	27 (24~30)	17	22	53						
Z15L330	33 (30~36)	20	26	65						
Z15L360	36 (35~43)	25	31	77						
Z15L470	47 (42~52)	30	38	93						
Z15L560	56 (50~62)	36	45	110						
Z15L680	68 (61~75)	40	56	135	0.6	14	4500A	2500A	2,900	
Z15L820	82 (74~90)	50	65	135 at 50A						
Z15L101	100 (90~110)	60	85	165						
Z15L121	120 (108~132)	75	100	200						
Z15L151	150 (135~165)	95	125	250						
Z15L181	180 (162~198)	110	145	300						
Z15L201	200 (185~225)	130	170	340						
Z15L221	220 (198~242)	140	180	360						
Z15L271	270 (247~303)	175	225	455						
Z15L331	330 (297~363)	210	275	550						
Z15L361	360 (324~396)	230	300	595						
Z15L391	390 (351~429)	250	320	650						
Z15L431	430 (387~473)	275	350	710						
Z15L471	470 (423~517)	300	385	775						
Z15L561	560 (504~616)	350	460	625						
Z15L681	680 (612~748)	420	560	1,120						
Z15L751	750 (675~825)	480	615	1,240						
Z15L821	820 (738~902)	510	670	1,355						
Z15L911	910 (819~1,001)	550	745	1,500						
Z15L102	1,000 (900~1,100)	625	825	1,650						

V-I characteristics

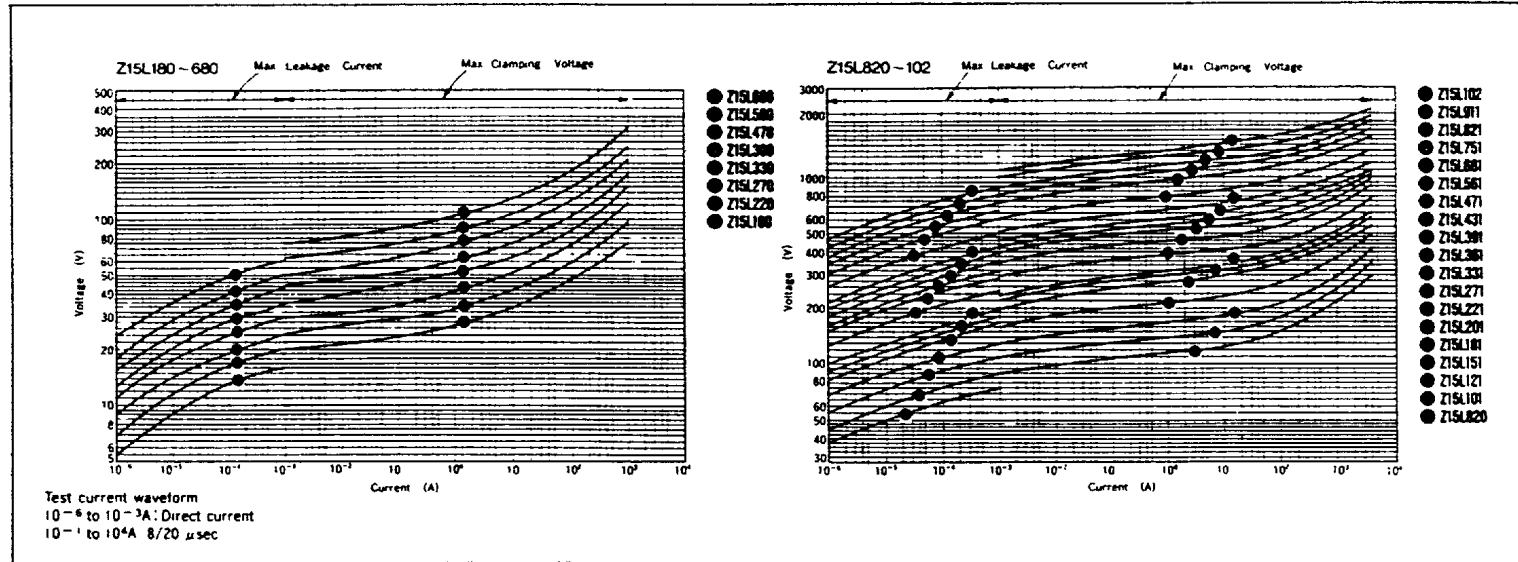

Surge Life Time Ratings (Relation between impulse width and surge repetition time)

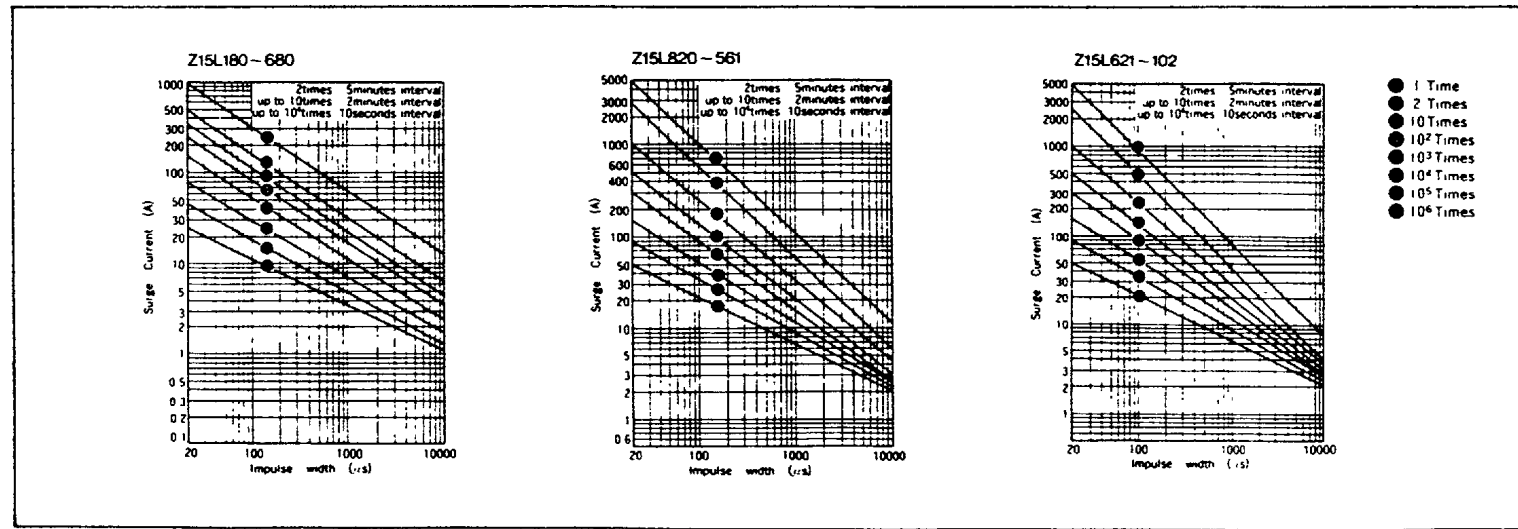

1. Operating temperature range: -40 to 85 °C
2. Storage temperature range: -40 to 125 °C
3. *: UL approved model

Z21L Series

Specifications

Type No.	Varistor voltage V_{VMA} (V)		Maximum allowable voltage		Maximum clamping voltage	Rated wattage	Energy (Jms)	Withstanding Surge current (8/20 μ s)		Typical capacitance (@ 1kHz)
			AC	DC				1 Time	2 Time	
	Min	Max	V_{rms}	V	V	W	J			pF
Z21L180	18 (16 ~ 20)	11	14	36 at 20A	0.2	10	2000A	1000A	37,000	
Z21L220	22 (20 ~ 24)	11	14	43		13			30,000	
Z21L270	27 (24 ~ 30)	17	22	53		15			22,000	
Z21L330	33 (30 ~ 36)	20	26	65		20			17,000	
Z21L390	39 (35 ~ 43)	25	31	77		24			15,000	
Z21L470	47 (42 ~ 52)	30	38	93		30			13,000	
Z21L560	56 (50 ~ 62)	35	45	110		35			11,000	
Z21L680	68 (61 ~ 75)	40	56	135		40			7,000	
Z21L820	82 (74 ~ 90)	50	65	135 at 100A	1.0	27	6500A	4000A	5,500	
Z21L101	100 (90 ~ 110)	60	85	165		30			4,800	
Z21L121	120 (108 ~ 132)	75	100	200		40			3,800	
Z21L151	150 (135 ~ 165)	95	125	250		50			3,000	
Z21L181	180 (162 ~ 198)	110	145	300		65			2,500	
Z21L201	200 (185 ~ 225)	130	170	340		70			2,000	
Z21L221	220 (198 ~ 242)	140	180	380		75			2,000	
Z21L271	270 (247 ~ 303)	175	225	455		90			1,800	
Z21L331	330 (297 ~ 363)	210	275	550		110			1,400	
Z21L361	360 (324 ~ 396)	230	300	595		120			1,200	
Z21L391	390 (351 ~ 429)	250	320	650		130			1,000	
Z21L431	430 (387 ~ 473)	275	350	710		140			900	
Z21L471	470 (423 ~ 517)	300	385	775		150			800	
Z21L561	560 (504 ~ 616)	350	460	625		150			460	
Z21L681	680 (612 ~ 748)	420	560	1,120		180			600	
Z21L751	750 (675 ~ 825)	460	615	1,240		175			420	
Z21L821	820 (738 ~ 902)	510	670	1,355		190			400	
Z21L911	910 (819 ~ 1,001)	550	745	1,500		215			350	
Z21L102	1,000 (900 ~ 1,100)	625	825	1,650		230			320	

V-I characteristics

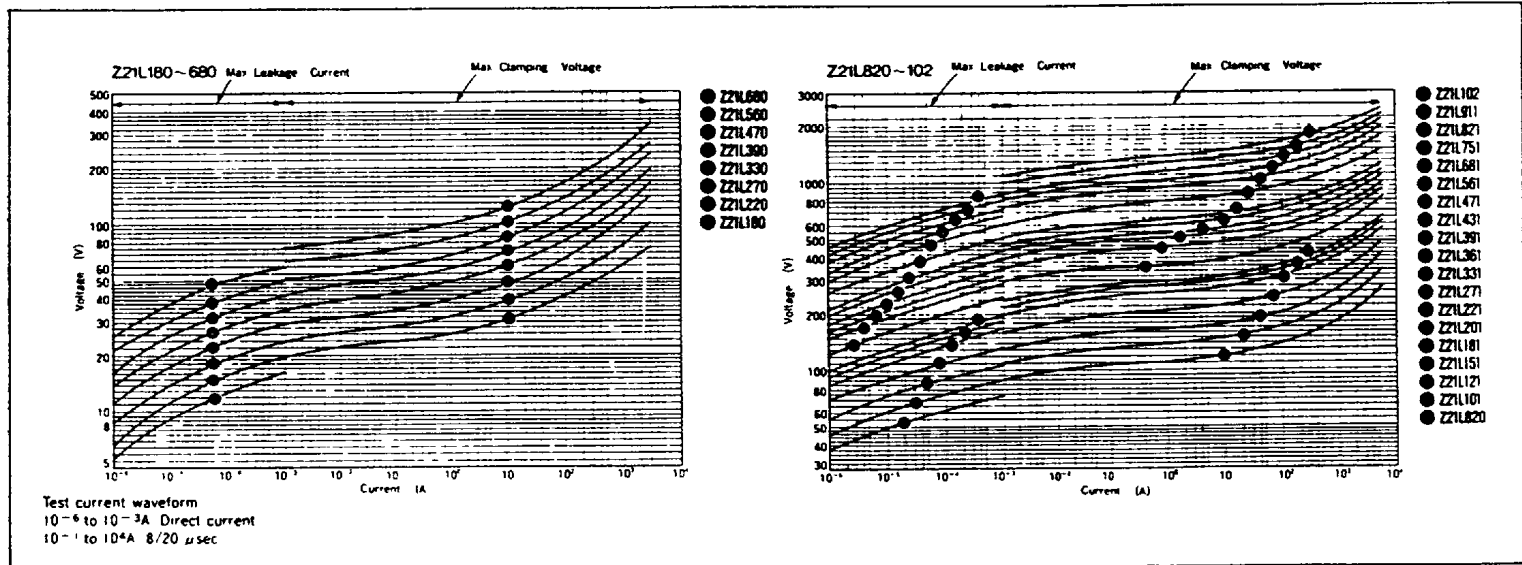

Surge Life Time Ratings (Relation between impulse width and surge repetition time)

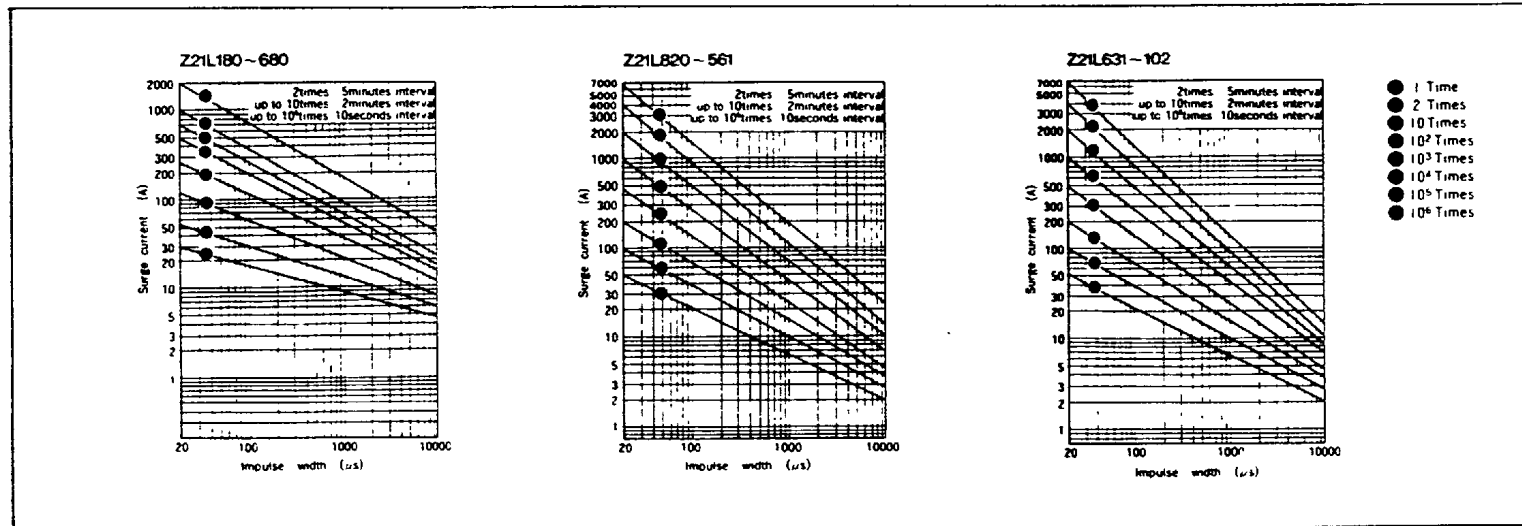

1. Operating temperature range: -40 to 85 °C
2. Storage temperature range: -40 to 125 °C
- 3 * : UL approved model

Specifications

Type No.	Varistor voltage V_{max} (V)		Maximum allowable voltage		Maximum clamping voltage	Rated wattage	Energy (Jms)	Withstanding Surge current (8/20 μ s)		Typical capacitance (@ 1kHz)
			AC	DC				1 Time	2 Times	
	Min	Max	V_{rms}	V	V	W	J			μ F
Z25M221S	220 (187 ~ 253)	120	165	380 at 100A	125	1.0	15000A	10000A	3.300	
Z25M271S	270 (229.5 ~ 310.5)	150	210	465	2.200					
Z25M331S	330 (280.5 ~ 379.5)	175	245	570	1.900					
Z25M381S	380 (331.5 ~ 448.5)	210	295	675	1.700					
Z25M441S	440 (374 ~ 506)	240	335	780	1.500					
Z25M471S	470 (399.5 ~ 540.5)	250	350	810	1.500					
Z25M561S	560 (476 ~ 644)	300	420	970	1.400					
Z25M681S	680 (578 ~ 782)	365	510	1,175	1,250					
Z25M821S	820 (697 ~ 943)	440	615	1,415	800					
Z25M102S	1000 (850 ~ 1,150)	520	730	1,725	500					
Z33M221S	220 (187 ~ 253)	120	165	380 at 100A	200	1.2	25000A	20000A	5.500	
Z33M271S	270 (229.5 ~ 310.5)	150	210	465	4.200					
Z33M331S	330 (280.5 ~ 379.5)	175	245	570	3.700					
Z33M381S	380 (331.5 ~ 448.5)	210	295	675	3.200					
Z33M441S	440 (374 ~ 506)	240	335	780	2.800					
Z33M471S	470 (399.5 ~ 540.5)	250	350	810	2.800					
Z33M561S	560 (476 ~ 644)	300	420	970	2.200					
Z33M681S	680 (578 ~ 782)	365	510	1,175	1.800					
Z33M821S	820 (697 ~ 943)	440	615	1,415	1,500					
Z33M102S	1000 (850 ~ 1,150)	520	730	1,725	1,000					

- 1. Operating temperature range: -40 to 85 °C
- 2. Storage temperature range: -40 to 125 °C

Dimensions

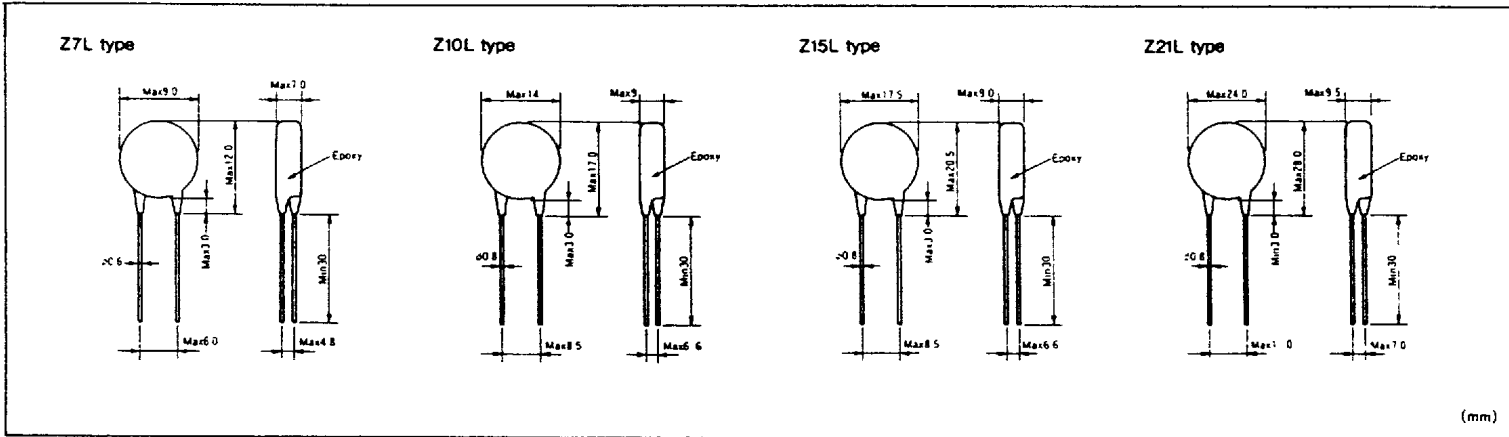

Dimensions

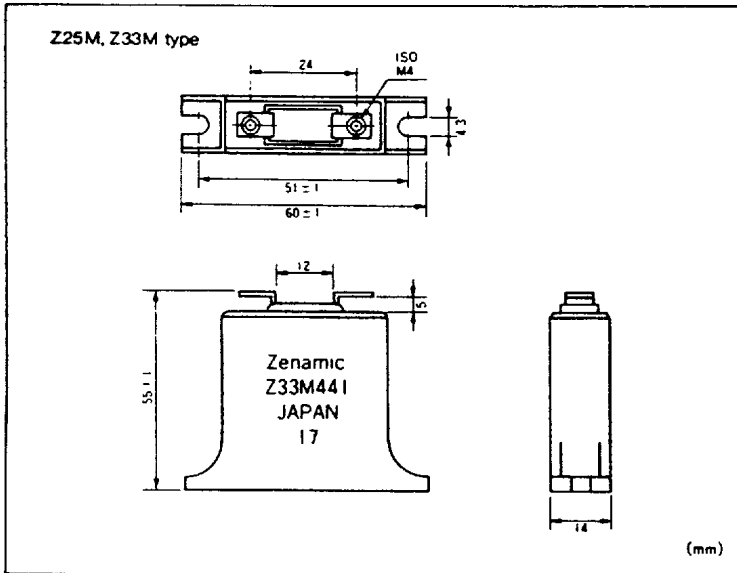

Taping

