

MUN2211T1 Series

Preferred Devices

Bias Resistor Transistors

NPN Silicon Surface Mount Transistors with Monolithic Bias Resistor Network

This new series of digital transistors is designed to replace a single device and its external resistor bias network. The BRT (Bias Resistor Transistor) contains a single transistor with a monolithic bias network consisting of two resistors; a series base resistor and a base-emitter resistor. The BRT eliminates these individual components by integrating them into a single device. The use of a BRT can reduce both system cost and board space. The device is housed in the SC-59 package which is designed for low power surface mount applications.

Features

- Simplifies Circuit Design
- Reduces Board Space
- Reduces Component Count
- Moisture Sensitivity Level: 1
- ESD Rating - Human Body Model: Class 1
- Machine Model: Class B
- The SC-59 Package can be Soldered Using Wave or Reflow
- The Modified Gull-Winged Leads Absorb Thermal Stress During Soldering Eliminating the Possibility of Damage to the Die
- Pb-Free Packages are Available

MAXIMUM RATINGS ($T_A = 25^\circ\text{C}$ unless otherwise noted)

Rating	Symbol	Value	Unit
Collector-Base Voltage	V_{CB0}	50	Vdc
Collector-Emitter Voltage	V_{CE0}	50	Vdc
Collector Current	I_C	100	mAdc

THERMAL CHARACTERISTICS

Characteristic	Symbol	Max	Unit
Total Device Dissipation $T_A = 25^\circ\text{C}$ Derate above 25°C	P_D	230 (Note 1) 338 (Note 2) 1.8 (Note 1) 2.7 (Note 2)	mW $^\circ\text{C/W}$
Thermal Resistance, Junction-to-Ambient	$R_{\theta JA}$	540 (Note 1) 370 (Note 2)	$^\circ\text{C/W}$
Thermal Resistance, Junction-to-Lead	$R_{\theta JL}$	264 (Note 1) 287 (Note 2)	$^\circ\text{C/W}$
Junction and Storage Temperature Range	T_J, T_{stg}	-55 to +150	$^\circ\text{C}$

Stresses exceeding Maximum Ratings may damage the device. Maximum Ratings are stress ratings only. Functional operation above the Recommended Operating Conditions is not implied. Extended exposure to stresses above the Recommended Operating Conditions may affect device reliability.

1. FR-4 @ Minimum Pad.
2. FR-4 @ 1.0 x 1.0 inch Pad.



ON Semiconductor®

<http://onsemi.com>

NPN SILICON BIAS RESISTOR TRANSISTORS

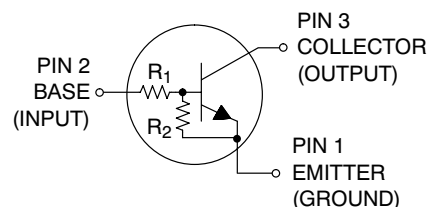

SC-59
CASE 318D
STYLE 1

MARKING DIAGRAM

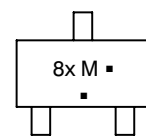

8x = Device Code (Refer to page 2)
M = Date Code*
▪ = Pb-Free Package

(Note: Microdot may be in either location)
*Date Code orientation may vary depending upon manufacturing location.

ORDERING INFORMATION

See detailed ordering and shipping information in the table on page 2 of this data sheet.

DEVICE MARKING INFORMATION

See specific marking information in the Device Marking and Resistor Values table on page 2 of this data sheet.

Preferred devices are recommended choices for future use and best overall value.

MUN2211T1 Series

DEVICE MARKING AND RESISTOR VALUES

Device	Package	Marking	R1 (K)	R2 (K)	Shipping [†]
MUN2211T1	SC-59	8A	10	10	3000/Tape & Reel
MUN2211T1G	SC-59 (Pb-Free)	8A	10	10	3000/Tape & Reel
MUN2211T3	SC-59	8A	10	10	10,000/Tape & Reel
MUN2211T3G	SC-59 (Pb-Free)	8A	10	10	10,000/Tape & Reel
MUN2212T1	SC-59	8B	22	22	3000/Tape & Reel
MUN2212T1G	SC-59 (Pb-Free)	8B	22	22	3000/Tape & Reel
MUN2213T1	SC-59	8C	47	47	3000/Tape & Reel
MUN2213T1G	SC-59 (Pb-Free)	8C	47	47	3000/Tape & Reel
MUN2214T1	SC-59	8D	10	47	3000/Tape & Reel
MUN2214T1G	SC-59 (Pb-Free)	8D	10	47	3000/Tape & Reel
MUN2214T3	SC-59	8D	10	47	10,000/Tape & Reel
MUN2214T3G	SC-59 (Pb-Free)	8D	10	47	10,000/Tape & Reel
MUN2215T1	SC-59	8E	10	∞	3000/Tape & Reel
MUN2215T1G	SC-59 (Pb-Free)	8E	10	∞	3000/Tape & Reel
MUN2216T1	SC-59	8F	4.7	∞	3000/Tape & Reel
MUN2216T1G	SC-59 (Pb-Free)	8F	4.7	∞	3000/Tape & Reel
MUN2230T1	SC-59	8G	1.0	1.0	3000/Tape & Reel
MUN2230T1G	SC-59 (Pb-Free)	8G	1.0	1.0	3000/Tape & Reel
MUN2231T1 (Note 3)	SC-59	8H	2.2	2.2	3000/Tape & Reel
MUN2231T1G (Note 3)	SC-59 (Pb-Free)	8H	2.2	2.2	3000/Tape & Reel
MUN2232T1	SC-59	8J	4.7	4.7	3000/Tape & Reel
MUN2232T1G	SC-59 (Pb-Free)	8J	4.7	4.7	3000/Tape & Reel
MUN2233T1	SC-59	8K	4.7	47	3000/Tape & Reel
MUN2233T1G	SC-59 (Pb-Free)	8K	4.7	47	3000/Tape & Reel
MUN2234T1 (Note 3)	SC-59	8L	22	47	3000/Tape & Reel
MUN2234T1G (Note 3)	SC-59 (Pb-Free)	8L	22	47	3000/Tape & Reel
MUN2236T1	SC-59	8N	100	100	3000/Tape & Reel
MUN2236T1G	SC-59 (Pb-Free)	8N	100	100	3000/Tape & Reel
MUN2237T1	SC-59	8P	47	22	3000/Tape & Reel
MUN2237T1G	SC-59 (Pb-Free)	8P	47	22	3000/Tape & Reel
MUN2240T1 (Note 3)	SC-59	8T	47	∞	3000/Tape & Reel
MUN2240T1G (Note 3)	SC-59 (Pb-Free)	8T	47	∞	3000/Tape & Reel
MUN2241T1 (Note 3)	SC-59	8U	100	∞	3000/Tape & Reel
MUN2241T1G (Note 3)	SC-59 (Pb-Free)	8U	100	∞	3000/Tape & Reel

[†]For information on tape and reel specifications, including part orientation and tape sizes, please refer to our Tape and Reel Packaging Specifications Brochure, BRD8011/D.

3. New devices. Updated curves to follow in subsequent data sheets.

MUN2211T1 Series

ELECTRICAL CHARACTERISTICS (T_A = 25°C unless otherwise noted)

Characteristic	Symbol	Min	Typ	Max	Unit
OFF CHARACTERISTICS					
Collector-Base Cutoff Current (V _{CB} = 50 V, I _E = 0)	I _{CBO}	-	-	100	nAdc
Collector-Emitter Cutoff Current (V _{CE} = 50 V, I _B = 0)	I _{CEO}	-	-	500	nAdc
Emitter-Base Cutoff Current (V _{EB} = 6.0 V, I _C = 0)	I _{EBO}	-	-	0.5	mAdc
MUN2211T1, G		-	-	0.2	
MUN2212T1, G		-	-	0.1	
MUN2213T1, G		-	-	0.2	
MUN2214T1, G		-	-	0.9	
MUN2215T1, G		-	-	1.9	
MUN2216T1, G		-	-	4.3	
MUN2230T1, G		-	-	2.3	
MUN2231T1, G		-	-	1.5	
MUN2232T1, G		-	-	0.18	
MUN2233T1, G		-	-	0.13	
MUN2234T1, G		-	-	0.05	
MUN2236T1, G		-	-	0.13	
MUN2237T1, G		-	-	0.2	
MUN2240T1, G		-	-	0.1	
MUN2241T1, G		-	-		
Collector-Base Breakdown Voltage (I _C = 10 μA, I _E = 0)	V _{(BR)CBO}	50	-	-	Vdc
Collector-Emitter Breakdown Voltage (Note 4) (I _C = 2.0 mA, I _B = 0)	V _{(BR)CEO}	50	-	-	Vdc

ON CHARACTERISTICS (Note 4)

DC Current Gain (V _{CE} = 10 V, I _C = 5.0 mA)	MUN2211T1, G	h _{FE}	35	60	-		
	MUN2212T1, G		60	100	-		
	MUN2213T1, G		80	140	-		
	MUN2214T1, G		80	140	-		
	MUN2215T1, G		160	350	-		
	MUN2216T1, G		160	350	-		
	MUN2230T1, G		3.0	5.0	-		
	MUN2231T1, G		8.0	15	-		
	MUN2232T1, G		15	30	-		
	MUN2233T1, G		80	200	-		
	MUN2234T1, G		80	150	-		
	MUN2236T1, G		80	150	-		
	MUN2237T1, G		80	140	-		
	MUN2240T1, G		160	350	-		
	MUN2241T1, G		160	350	-		
Collector-Emitter Saturation Voltage (I _C = 10 mA, I _B = 0.3 mA)	MUN2211T1, G	V _{CE(sat)}	-	-	0.25	Vdc	
	MUN2212T1, G		-	-	0.25		
	MUN2213T1, G		-	-	0.25		
	MUN2214T1, G		-	-	0.25		
	MUN2233T1, G		-	-	0.25		
	MUN2236T1, G		-	-	0.25		
	(I _C = 10 mA, I _B = 5 mA)	MUN2230T1, G		-	-	0.25	
		MUN2231T1, G		-	-	0.25	
		MUN2237T1, G		-	-	0.25	
	(I _C = 10 mA, I _B = 1 mA)	MUN2241T1, G		-	-	0.25	
		MUN2215T1, G		-	-	0.25	
		MUN2216T1, G		-	-	0.25	
		MUN2232T1, G		-	-	0.25	
		MUN2234T1, G		-	-	0.25	
	MUN2240T1, G		-	-	0.25		

4. Pulse Test: Pulse Width < 300 μs, Duty Cycle < 2.0%.

MUN2211T1 Series

ELECTRICAL CHARACTERISTICS (T_A = 25°C unless otherwise noted) (Continued)

Characteristic	Symbol	Min	Typ	Max	Unit	
ON CHARACTERISTICS (Note 5) (Continued)						
Output Voltage (on) (V _{CC} = 5.0 V, V _B = 2.5 V, R _L = 1.0 kΩ)	MUN2211T1, G MUN2212T1, G MUN2214T1, G MUN2215T1, G MUN2216T1, G MUN2230T1, G MUN2231T1, G MUN2232T1, G MUN2233T1, G MUN2234T1, G (V _{CC} = 5.0 V, V _B = 3.5 V, R _L = 1.0 kΩ) MUN2213T1, G MUN2240T1, G (V _{CC} = 5.0 V, V _B = 5.5 V, R _L = 1.0 kΩ) MUN2236T1, G (V _{CC} = 5.0 V, V _B = 4.0 V, R _L = 1.0 kΩ) MUN2237T1, G (V _{CC} = 5.0 V, V _B = 5.0 V, R _L = 1.0 kΩ) MUN2241T1, G	V _{OL}	-	-	0.2	Vdc
Output Voltage (off) (V _{CC} = 5.0 V, V _B = 0.5 V, R _L = 1.0 kΩ)	MUN2211T1, G MUN2212T1, G MUN2213T1, G MUN2214T1, G MUN2233T1, G MUN2234T1, G (V _{CC} = 5.0 V, V _B = 0.050 V, R _L = 1.0 kΩ) MUN2230T1, G (V _{CC} = 5.0 V, V _B = 0.25 V, R _L = 1.0 kΩ) MUN2215T1, G MUN2216T1, G MUN2231T1, G MUN2232T1, G MUN2236T1, G MUN2237T1, G MUN2240T1, G MUN2241T1, G	V _{OH}	4.9	-	-	Vdc
Input Resistor	MUN2211T1, G MUN2212T1, G MUN2213T1, G MUN2214T1, G MUN2215T1, G MUN2216T1, G MUN2230T1, G MUN2231T1, G MUN2232T1, G MUN2233T1, G MUN2234T1, G MUN2236T1, G MUN2237T1, G MUN2240T1, G MUN2241T1, G	R ₁	7.0 15.4 32.9 7.0 7.0 3.3 0.7 1.5 3.3 3.3 15.4 70 32.9 32.9 70	10 22 47 10 10 4.7 1.0 2.2 4.7 4.7 22 100 47 47 100	13 28.6 61.1 13 13 6.1 1.3 2.9 6.1 6.1 28.6 130 61.1 61.1 130	kΩ
Resistor Ratio	MUN2211T1, G MUN2212T1, G MUN2213T1, G MUN2214T1, G MUN2215T1, G MUN2216T1, G MUN2230T1, G MUN2231T1, G MUN2232T1, G MUN2233T1, G MUN2234T1, G MUN2236T1, G MUN2237T1, G MUN2240T1, G MUN2241T1, G	R ₁ /R ₂	0.8 0.8 0.8 0.17 - - 0.8 0.8 0.8 0.8 0.055 0.38 0.8 1.7 - -	1.0 1.0 1.0 0.21 - - 1.0 1.0 1.0 1.0 0.12 0.47 1.0 2.15 - -	1.2 1.2 1.2 0.25 - - 1.2 1.2 1.2 1.2 0.185 0.56 1.2 2.6 - -	

5. Pulse Test: Pulse Width < 300 μs, Duty Cycle < 2.0%.

MUN2211T1 Series

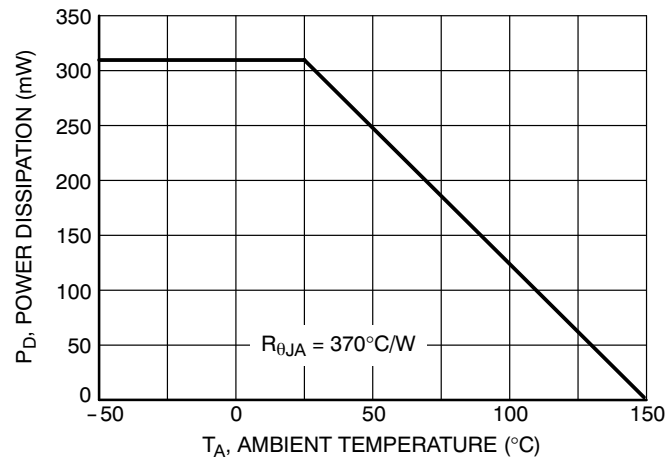

Figure 1. Derating Curve

MUN2211T1 Series

TYPICAL ELECTRICAL CHARACTERISTICS - MUN2211T1

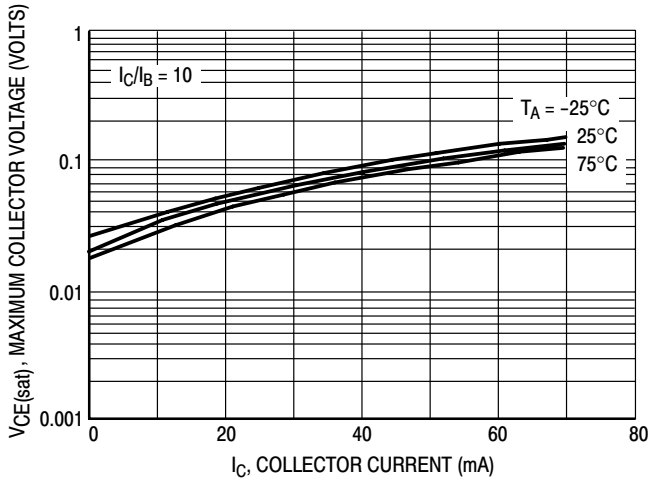

Figure 2. $V_{CE(sat)}$ versus I_C

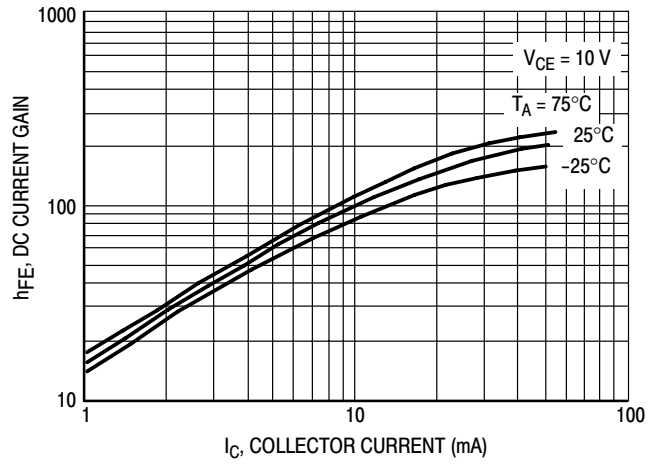

Figure 3. DC Current Gain

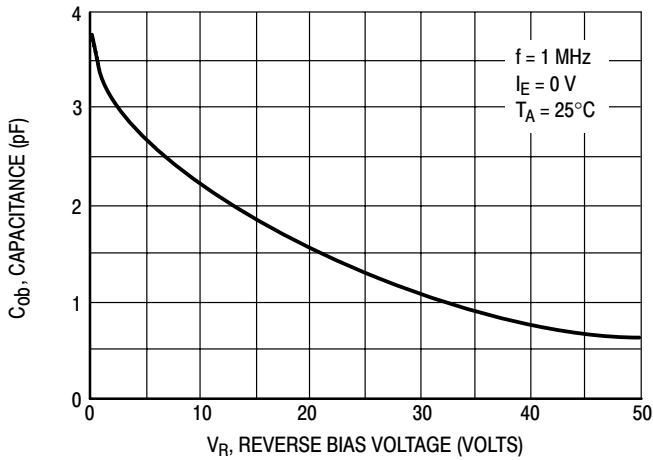

Figure 4. Output Capacitance

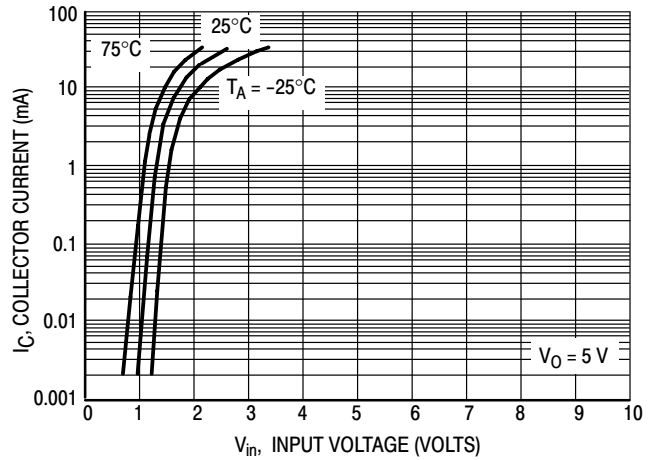

Figure 5. Output Current versus Input Voltage

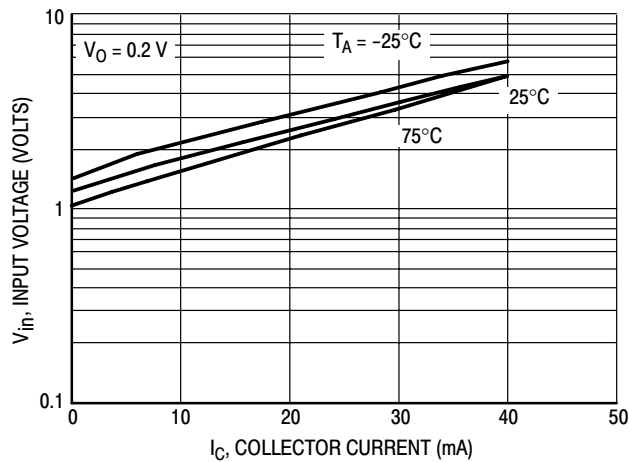

Figure 6. Input Voltage versus Output Current

MUN2211T1 Series

TYPICAL ELECTRICAL CHARACTERISTICS - MUN2212T1

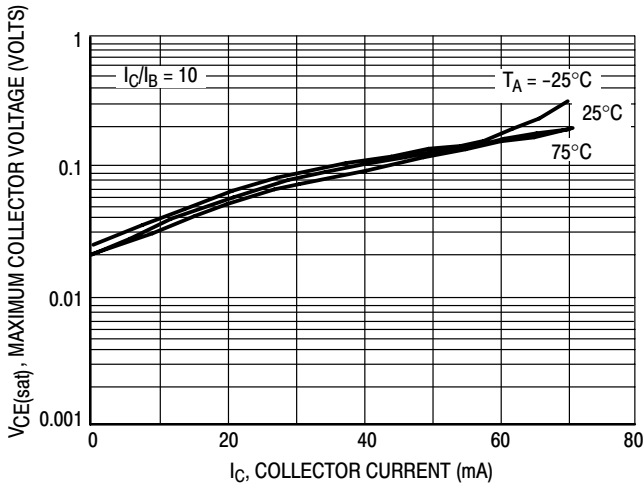

Figure 7. $V_{CE(sat)}$ versus I_C

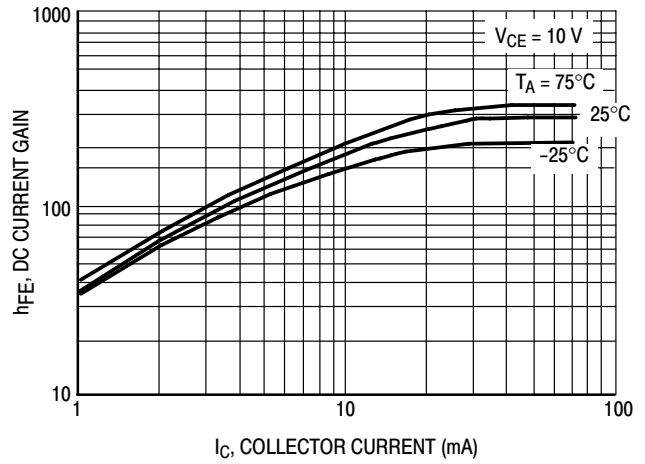

Figure 8. DC Current Gain

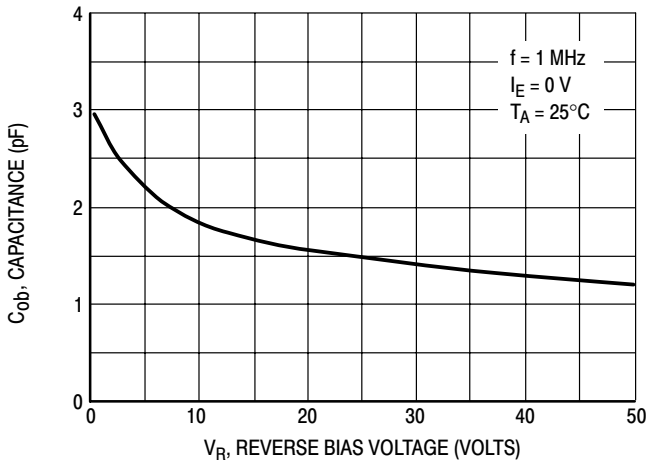

Figure 9. Output Capacitance

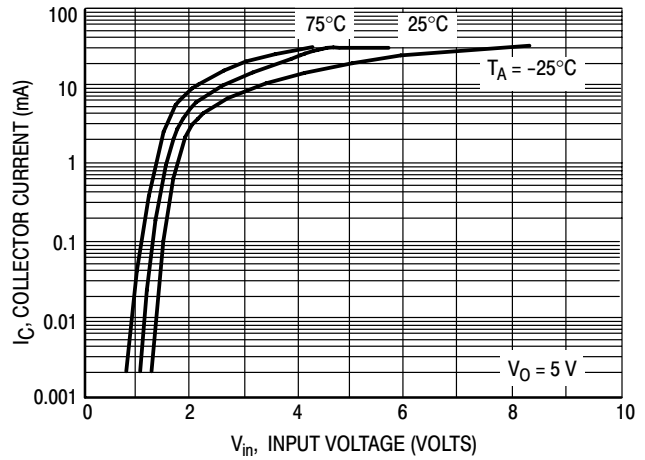

Figure 10. Output Current versus Input Voltage

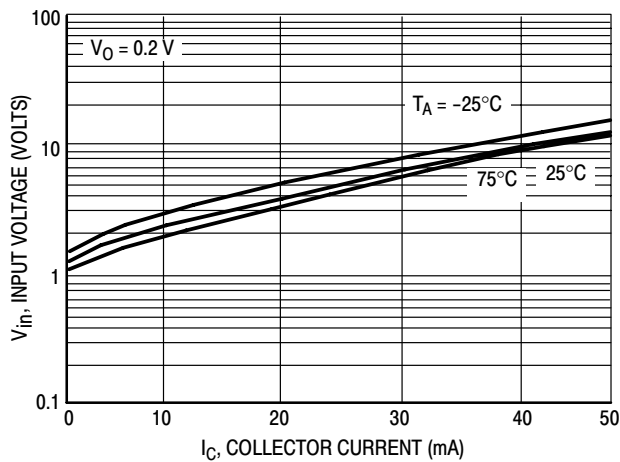

Figure 11. Input Voltage versus Output Current

MUN2211T1 Series

TYPICAL ELECTRICAL CHARACTERISTICS - MUN2213T1

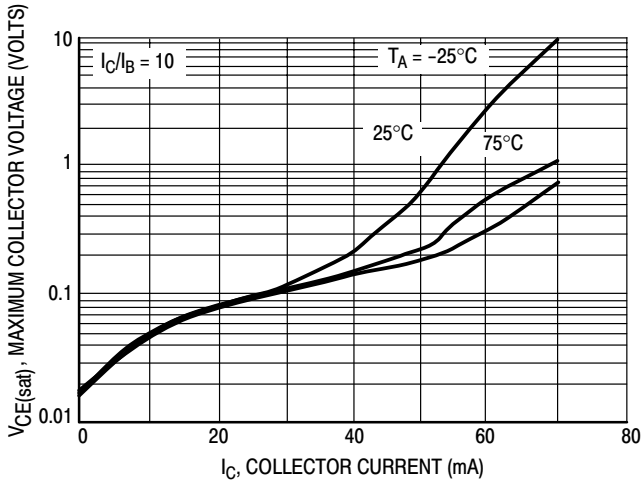

Figure 12. $V_{CE(sat)}$ versus I_C

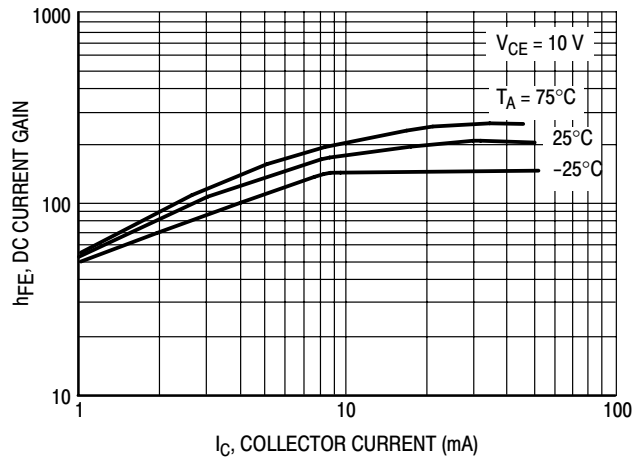

Figure 13. DC Current Gain

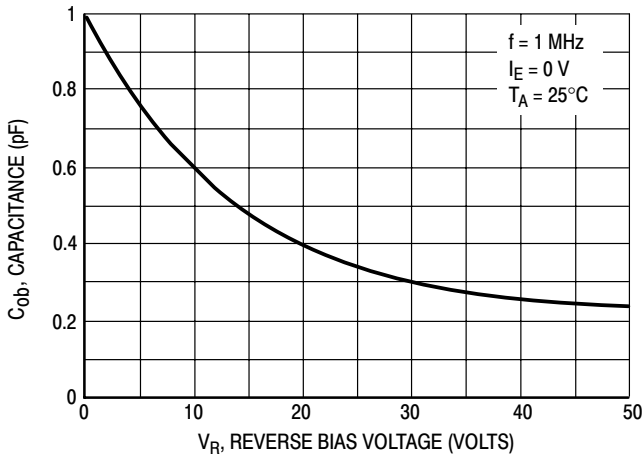

Figure 14. Output Capacitance

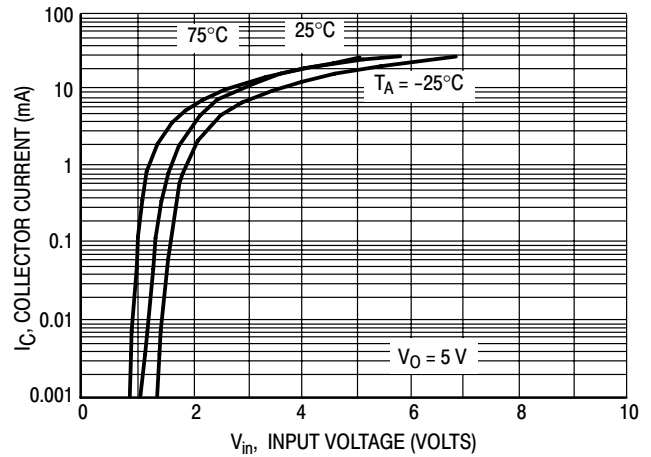

Figure 15. Output Current versus Input Voltage

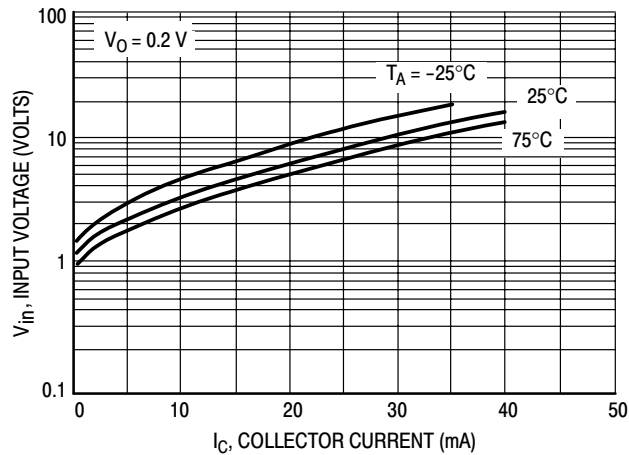

Figure 16. Input Voltage versus Output Current

MUN2211T1 Series

TYPICAL ELECTRICAL CHARACTERISTICS - MUN2214T1

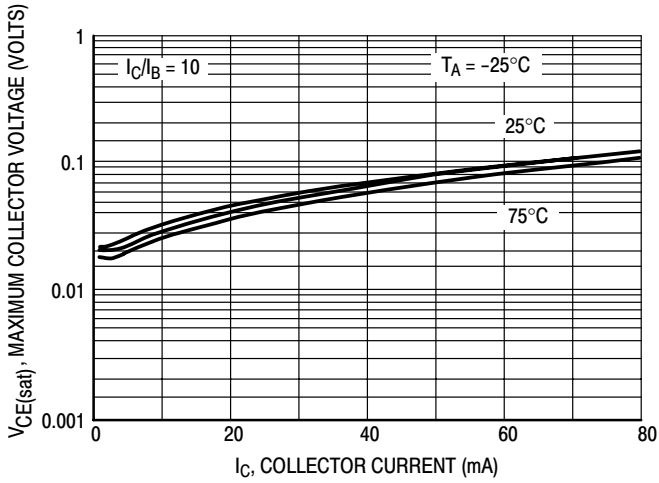

Figure 17. $V_{CE(sat)}$ versus I_C

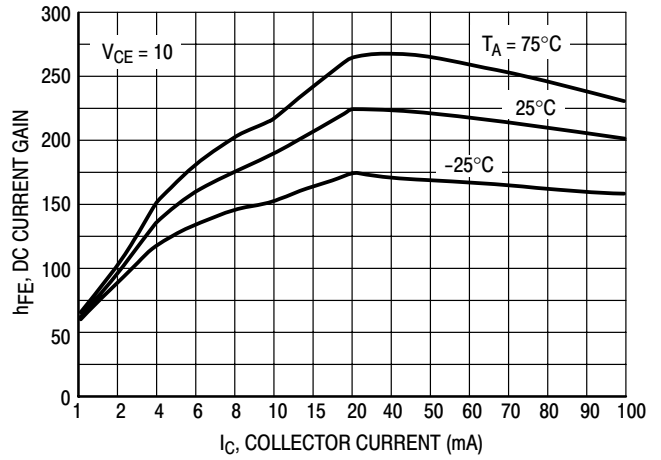

Figure 18. DC Current Gain

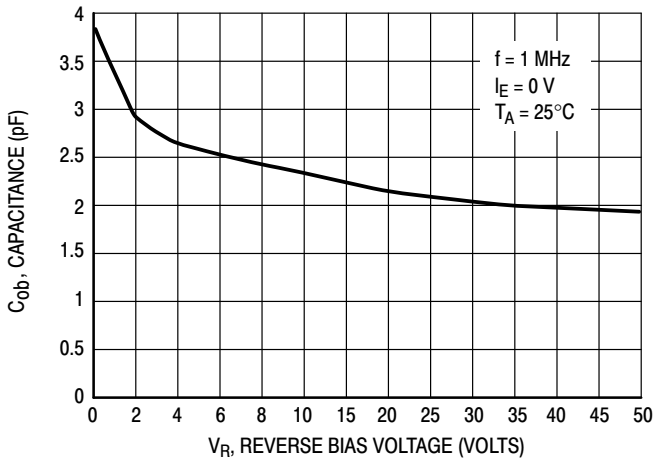

Figure 19. Output Capacitance

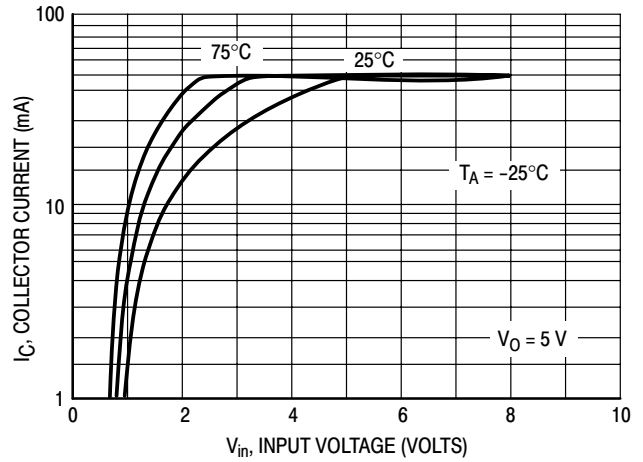

Figure 20. Output Current versus Input Voltage

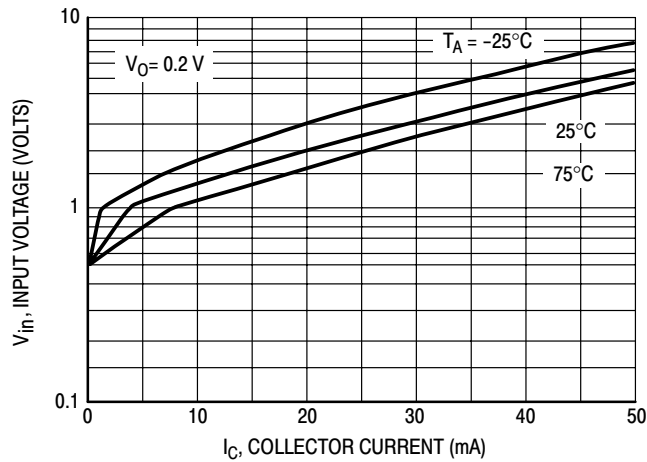

Figure 21. Input Voltage versus Output Current

MUN2211T1 Series

TYPICAL ELECTRICAL CHARACTERISTICS — MUN2215T1

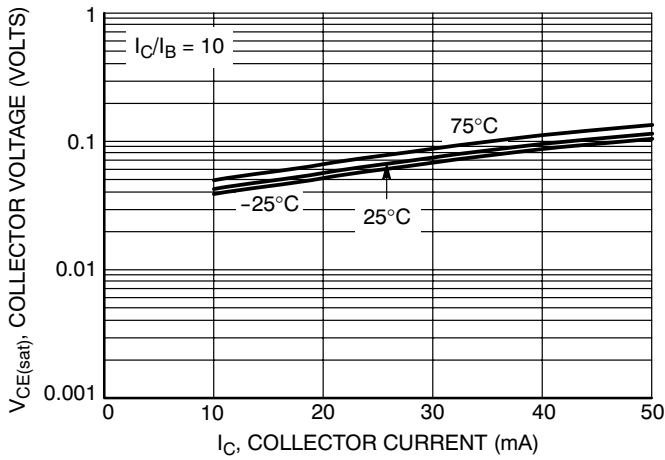

Figure 22. $V_{CE(sat)}$ versus I_C

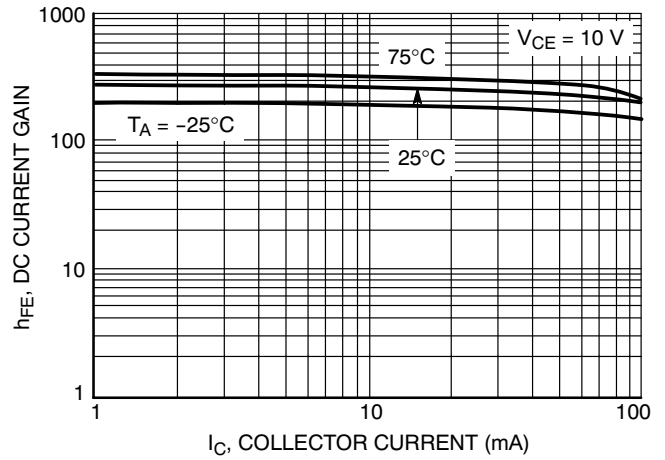

Figure 23. DC Current Gain

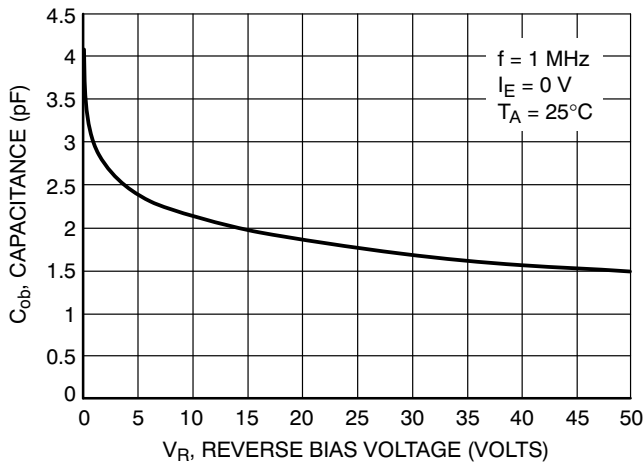

Figure 24. Output Capacitance

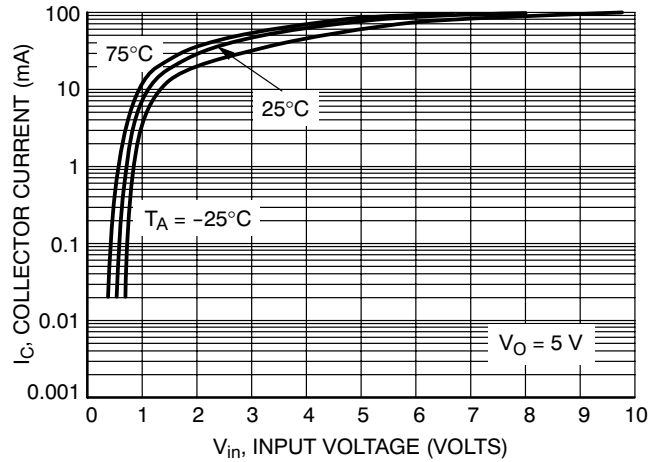

Figure 25. Output Current versus Input Voltage

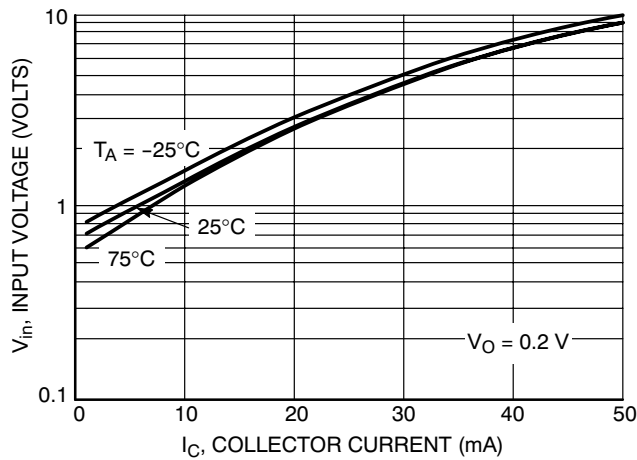

Figure 26. Input Voltage versus Output Current

MUN2211T1 Series

TYPICAL ELECTRICAL CHARACTERISTICS — MUN2216T1

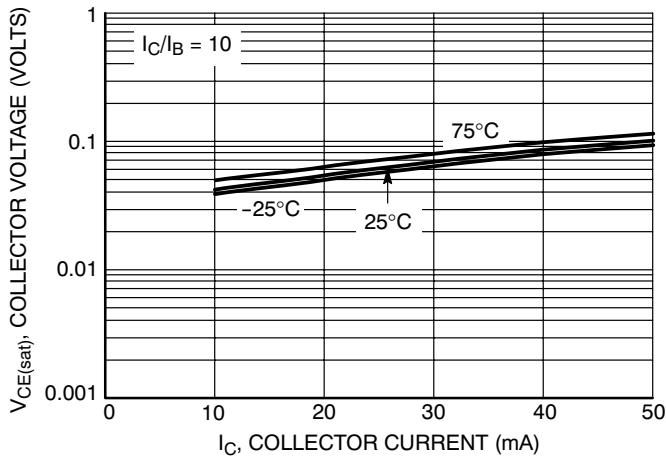

Figure 27. $V_{CE(sat)}$ versus I_C

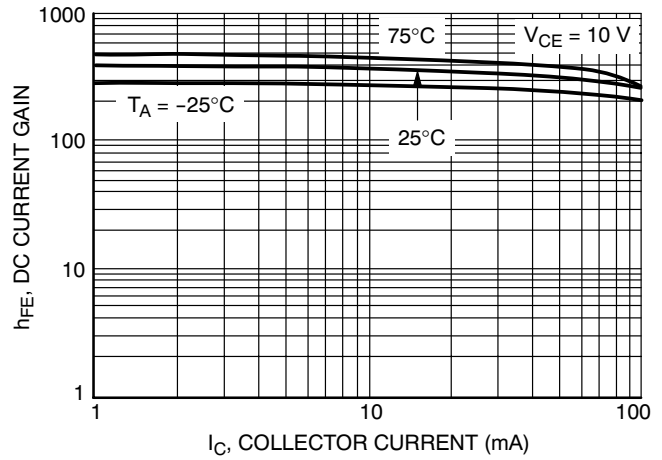

Figure 28. DC Current Gain

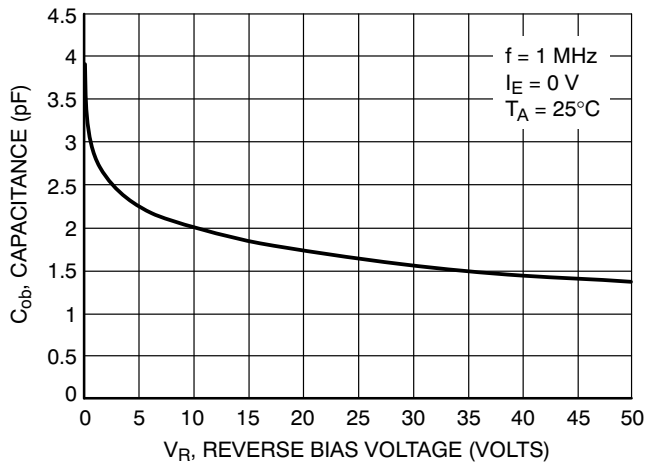

Figure 29. Output Capacitance

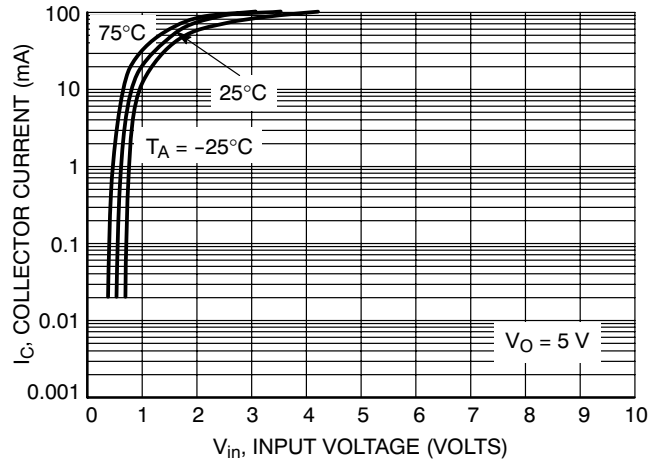

Figure 30. Output Current versus Input Voltage

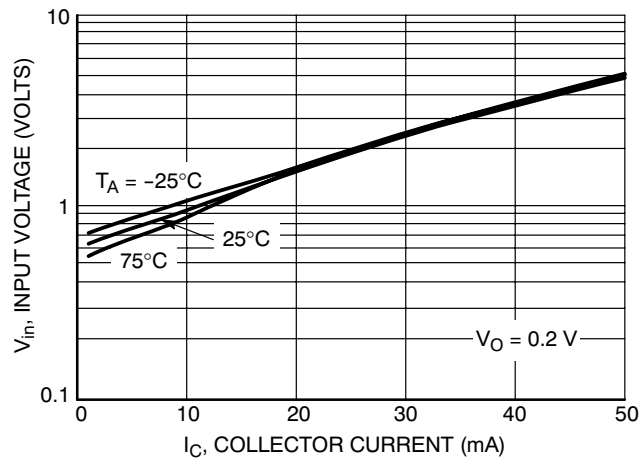

Figure 31. Input Voltage versus Output Current

MUN2211T1 Series

TYPICAL ELECTRICAL CHARACTERISTICS — MUN2230T1

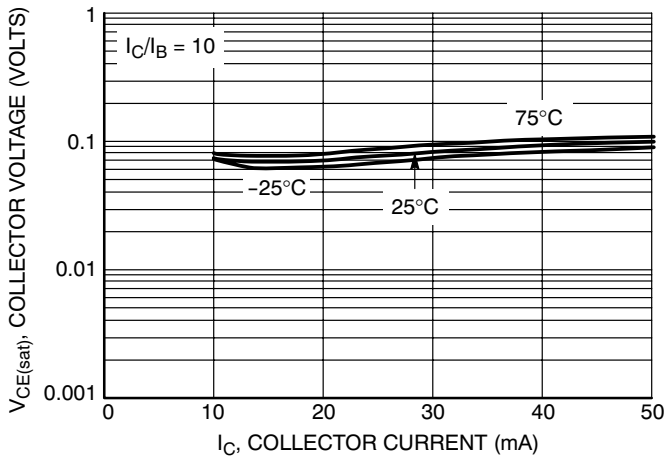

Figure 32. $V_{CE(sat)}$ versus I_C

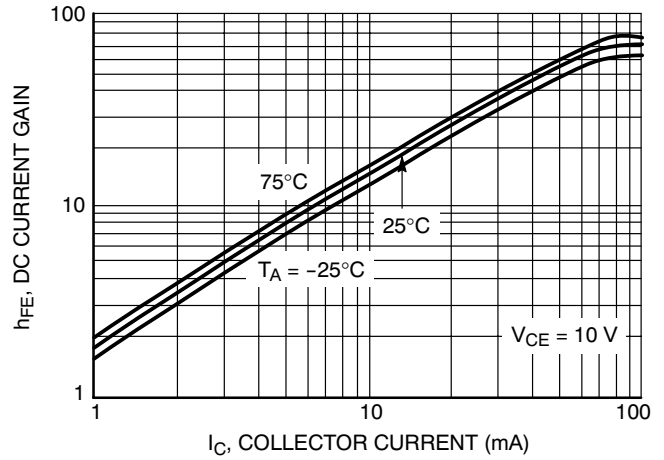

Figure 33. DC Current Gain

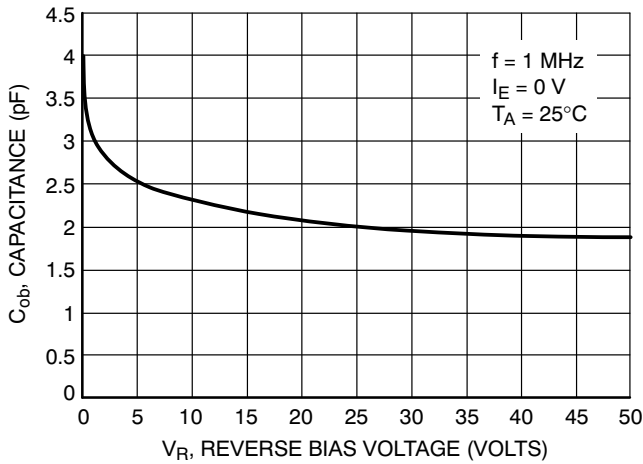

Figure 34. Output Capacitance

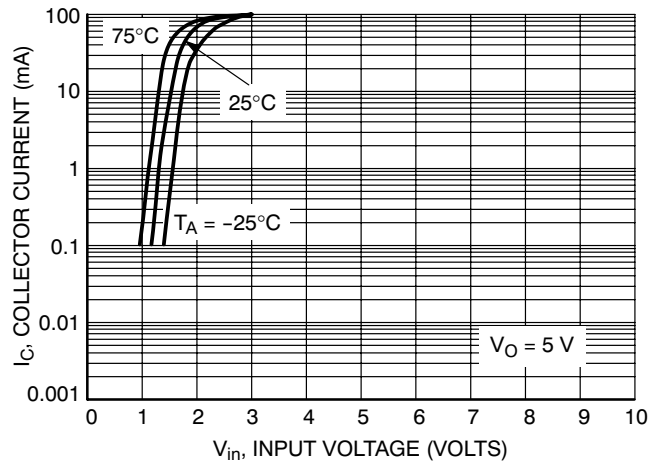

Figure 35. Output Current versus Input Voltage

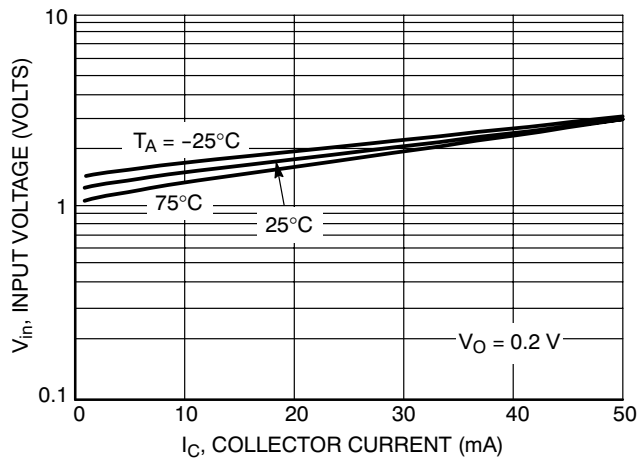

Figure 36. Input Voltage versus Output Current

MUN2211T1 Series

TYPICAL ELECTRICAL CHARACTERISTICS — MUN2232T1

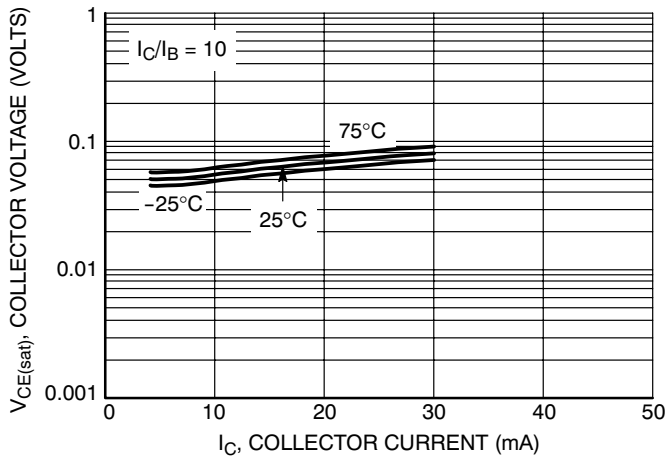

Figure 37. $V_{CE(sat)}$ versus I_C

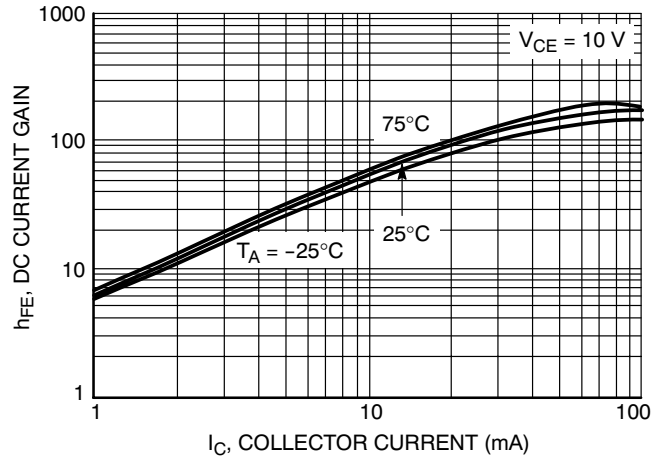

Figure 38. DC Current Gain

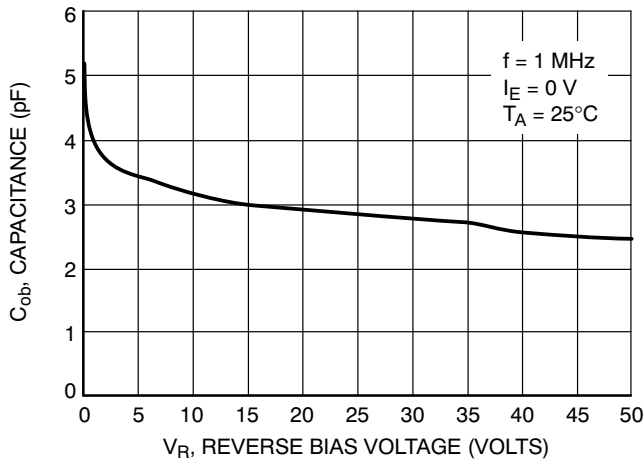

Figure 39. Output Capacitance

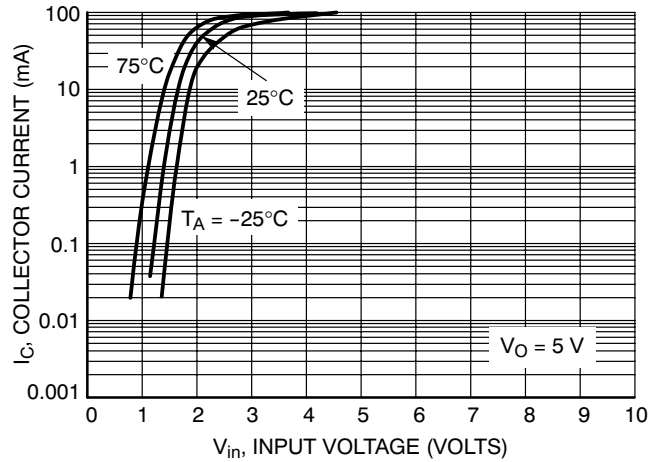

Figure 40. Output Current versus Input Voltage

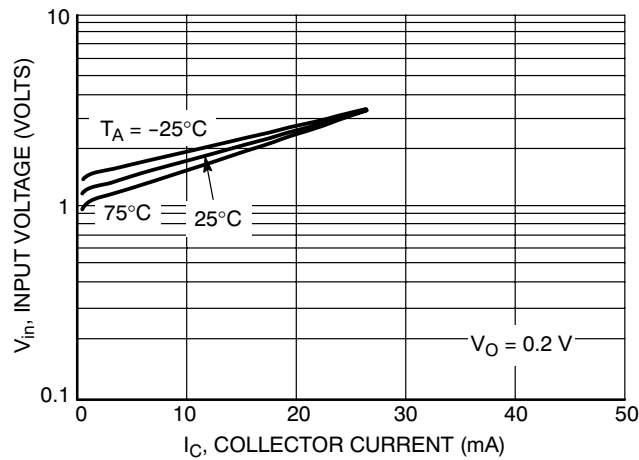

Figure 41. Input Voltage versus Output Current

MUN2211T1 Series

TYPICAL ELECTRICAL CHARACTERISTICS — MUN2233T1

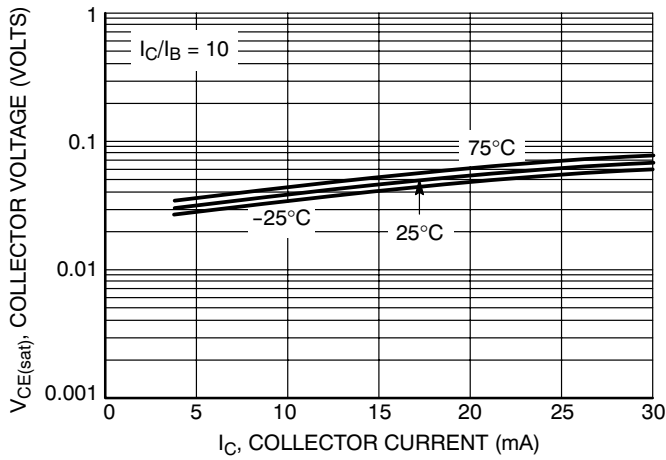

Figure 42. $V_{CE(sat)}$ versus I_C

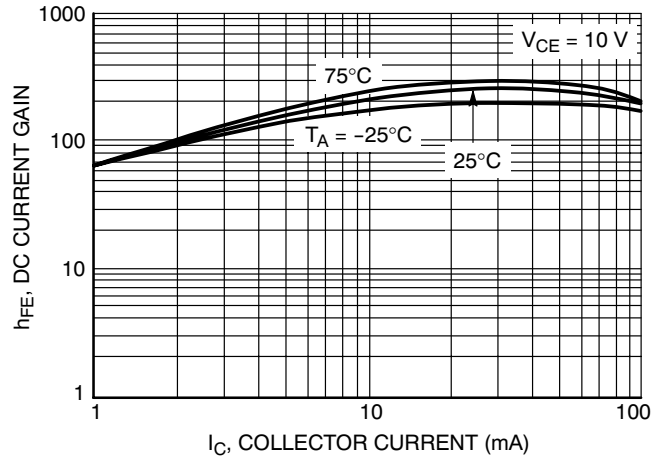

Figure 43. DC Current Gain

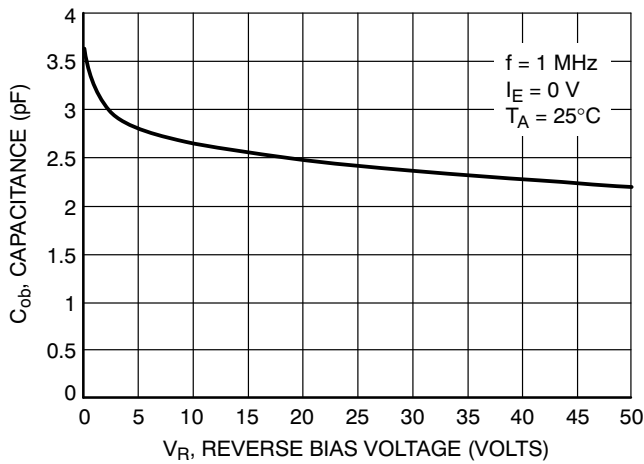

Figure 44. Output Capacitance

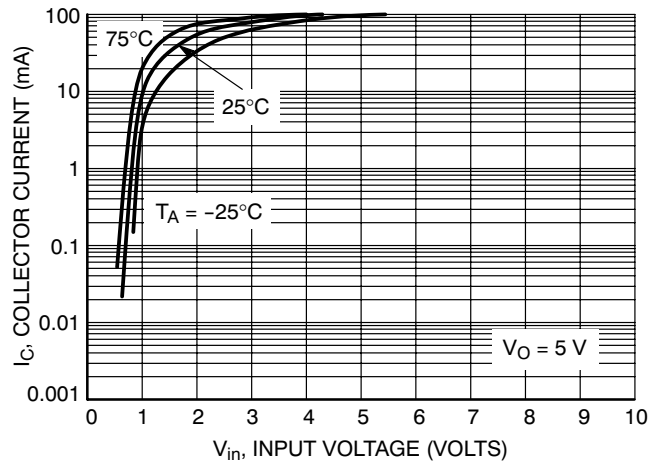

Figure 45. Output Current versus Input Voltage

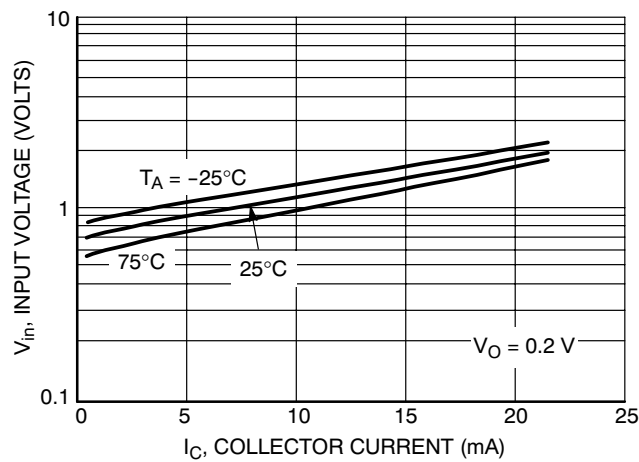

Figure 46. Input Voltage versus Output Current

MUN2211T1 Series

TYPICAL ELECTRICAL CHARACTERISTICS - MUN2236T1

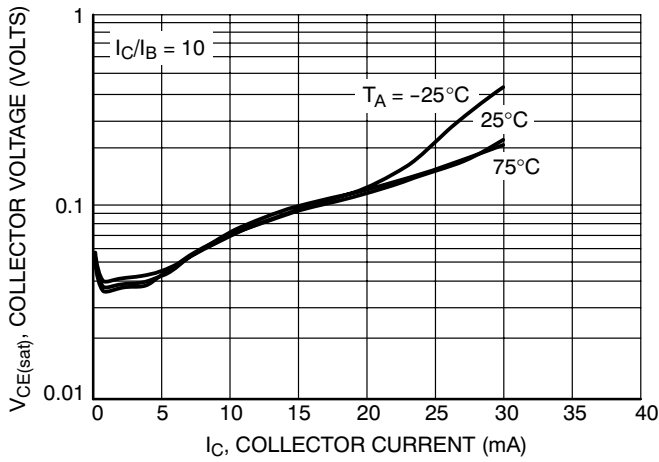

Figure 47. $V_{CE(sat)}$ versus I_C

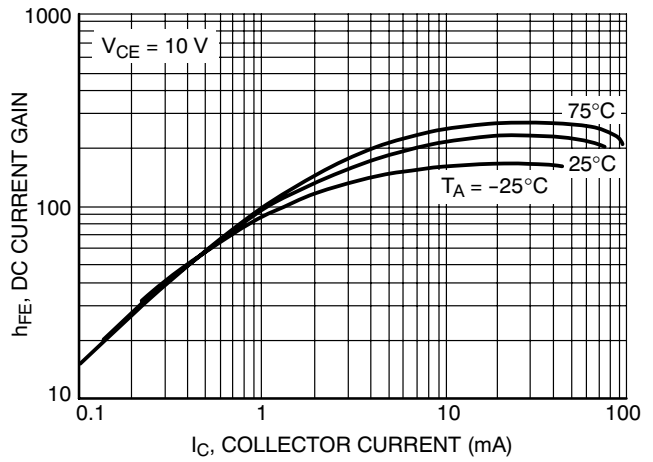

Figure 48. DC Current Gain

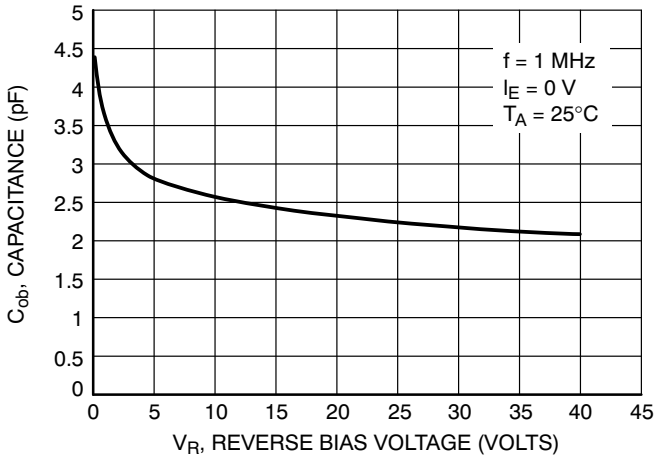

Figure 49. Output Capacitance

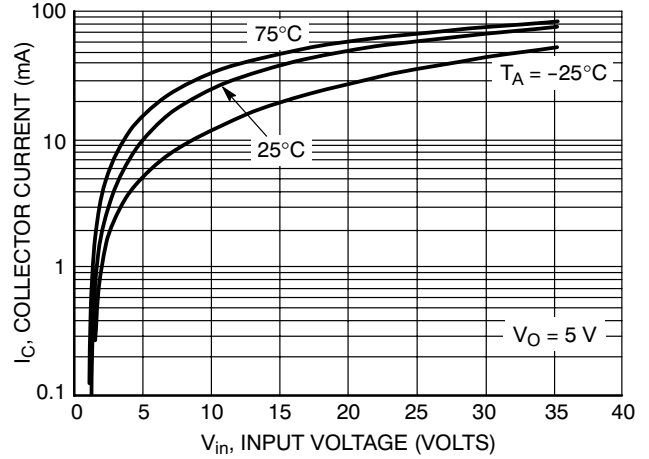

Figure 50. Output Current versus Input Voltage

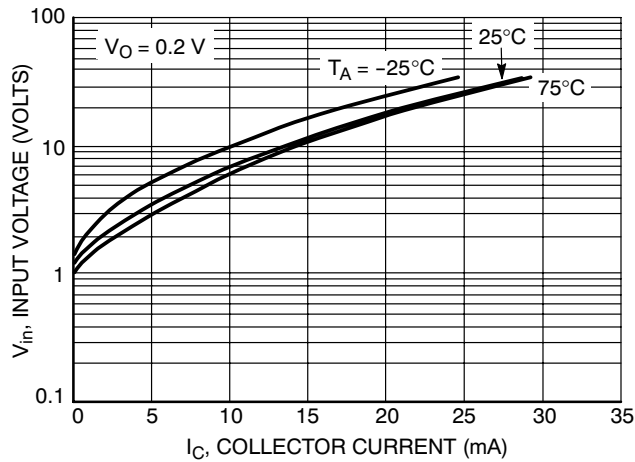

Figure 51. Input Voltage versus Output Current

MUN2211T1 Series

TYPICAL ELECTRICAL CHARACTERISTICS - MUN2237T1

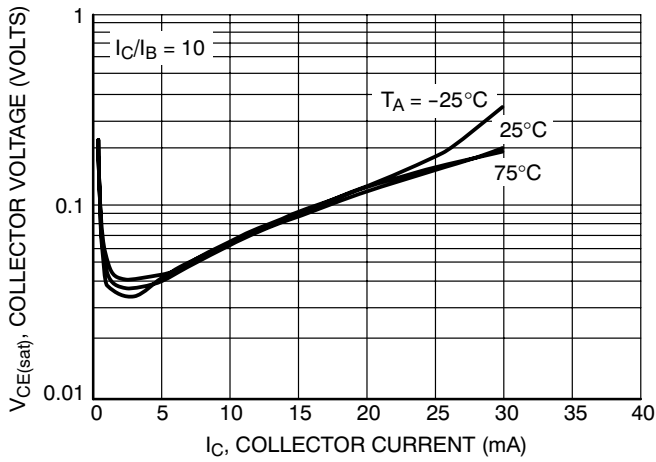

Figure 52. $V_{CE(sat)}$ versus I_C

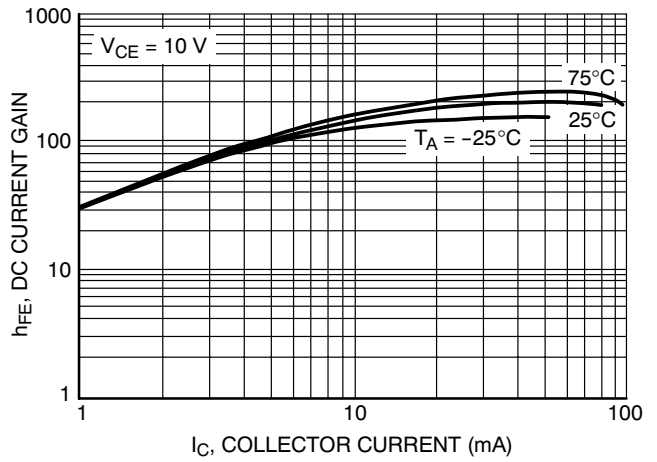

Figure 53. DC Current Gain

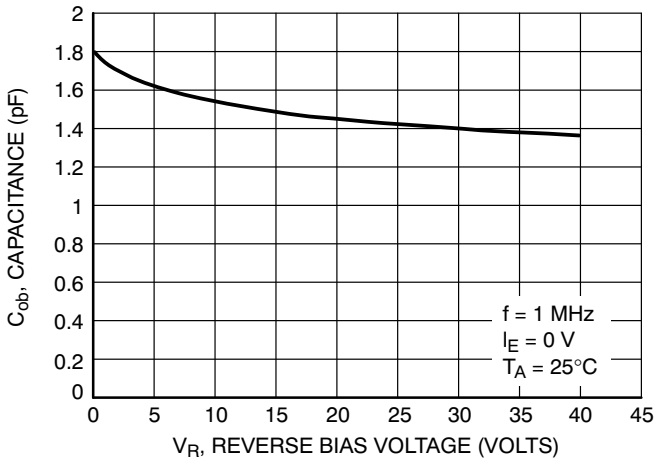

Figure 54. Output Capacitance

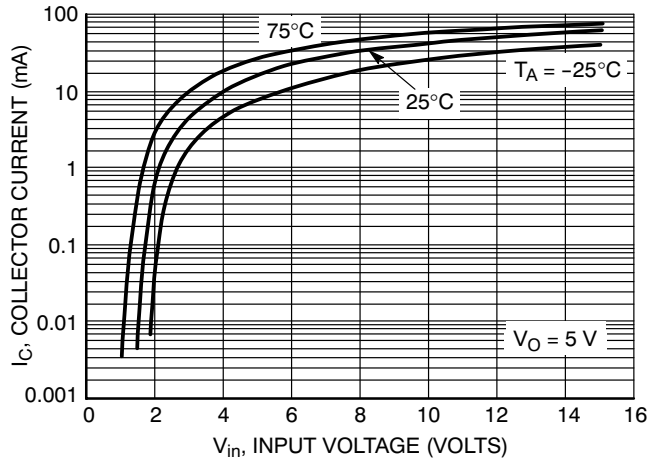

Figure 55. Output Current versus Input Voltage

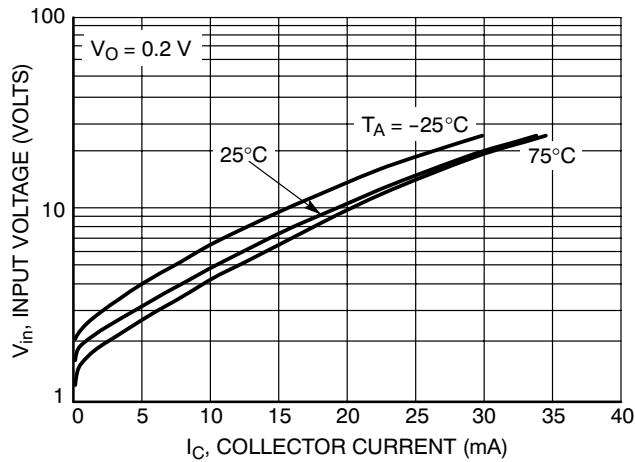

Figure 56. Input Voltage versus Output Current

MUN2211T1 Series

TYPICAL APPLICATIONS FOR NPN BRTs

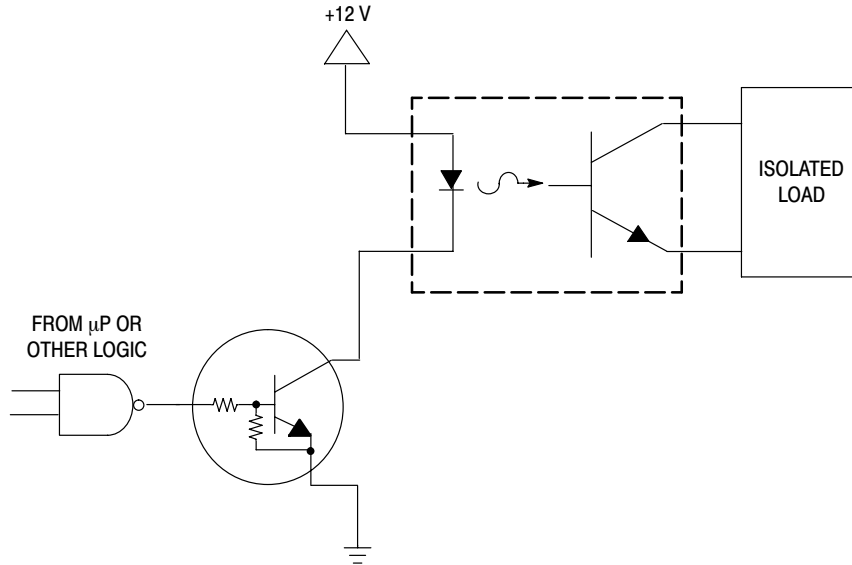

Figure 57. Level Shifter: Connects 12 or 24 Volt Circuits to Logic

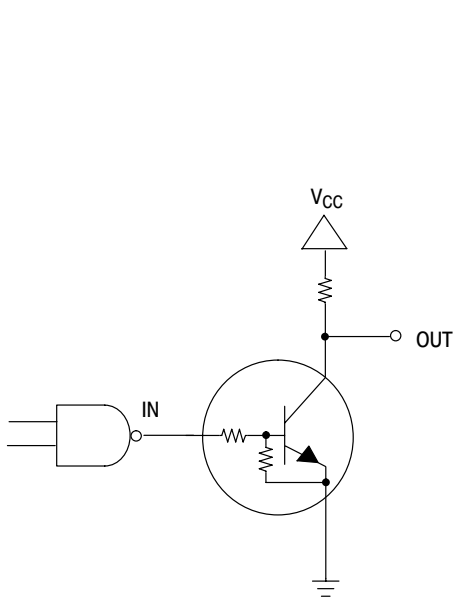

Figure 58. Open Collector Inverter:
Inverts the Input Signal

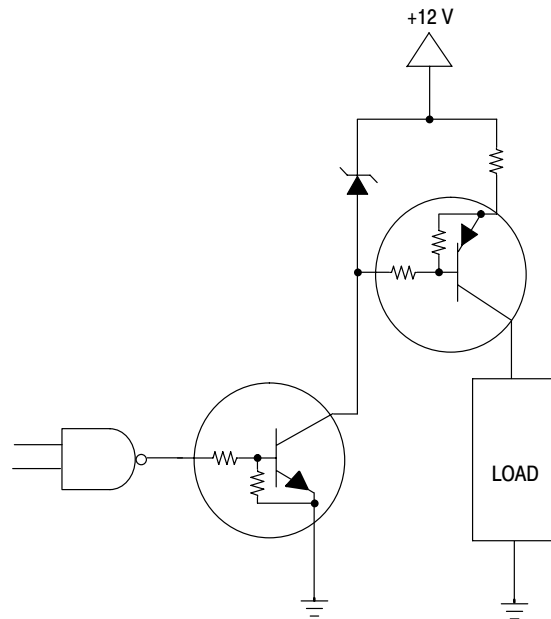
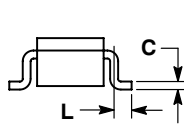
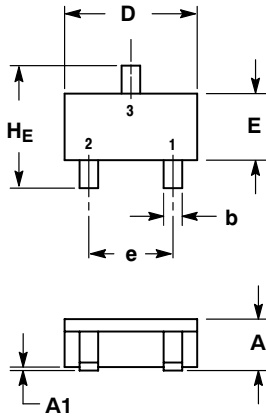

Figure 59. Inexpensive, Unregulated Current Source

MUN2211T1 Series

PACKAGE DIMENSIONS

SC-59
CASE 318D-04
ISSUE G



NOTES:

1. DIMENSIONING AND TOLERANCING PER ANSI Y14.5M, 1982.
2. CONTROLLING DIMENSION: MILLIMETER.

DIM	MILLIMETERS			INCHES		
	MIN	NOM	MAX	MIN	NOM	MAX
A	1.00	1.15	1.30	0.039	0.045	0.051
A1	0.01	0.06	0.10	0.001	0.002	0.004
b	0.35	0.43	0.50	0.014	0.017	0.020
c	0.09	0.14	0.18	0.003	0.005	0.007
D	2.70	2.90	3.10	0.106	0.114	0.122
E	1.30	1.50	1.70	0.051	0.059	0.067
e	1.70	1.90	2.10	0.067	0.075	0.083
L	0.20	0.40	0.60	0.008	0.016	0.024
HE	2.50	2.80	3.00	0.099	0.110	0.118

STYLE 1:

1. EMITTER
2. BASE
3. COLLECTOR

SOLDERING FOOTPRINT*

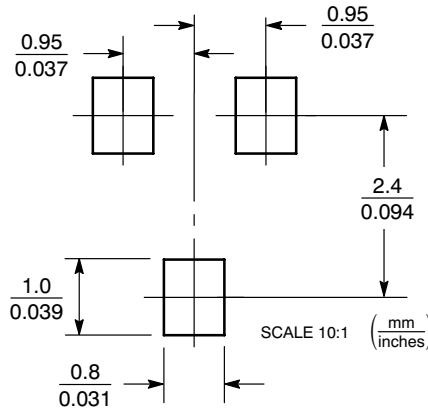

*For additional information on our Pb-Free strategy and soldering details, please download the ON Semiconductor Soldering and Mounting Techniques Reference Manual, SOLDERRM/D.

ON Semiconductor and are registered trademarks of Semiconductor Components Industries, LLC (SCILLC). SCILLC reserves the right to make changes without further notice to any products herein. SCILLC makes no warranty, representation or guarantee regarding the suitability of its products for any particular purpose, nor does SCILLC assume any liability arising out of the application or use of any product or circuit, and specifically disclaims any and all liability, including without limitation special, consequential or incidental damages. "Typical" parameters which may be provided in SCILLC data sheets and/or specifications can and do vary in different applications and actual performance may vary over time. All operating parameters, including "Typicals" must be validated for each customer application by customer's technical experts. SCILLC does not convey any license under its patent rights nor the rights of others. SCILLC products are not designed, intended, or authorized for use as components in systems intended for surgical implant into the body, or other applications intended to support or sustain life, or for any other application in which the failure of the SCILLC product could create a situation where personal injury or death may occur. Should Buyer purchase or use SCILLC products for any such unintended or unauthorized application, Buyer shall indemnify and hold SCILLC and its officers, employees, subsidiaries, affiliates, and distributors harmless against all claims, costs, damages, and expenses, and reasonable attorney fees arising out of, directly or indirectly, any claim of personal injury or death associated with such unintended or unauthorized use, even if such claim alleges that SCILLC was negligent regarding the design or manufacture of the part. SCILLC is an Equal Opportunity/Affirmative Action Employer. This literature is subject to all applicable copyright laws and is not for resale in any manner.

PUBLICATION ORDERING INFORMATION

LITERATURE FULFILLMENT:
Literature Distribution Center for ON Semiconductor
P.O. Box 5163, Denver, Colorado 80217 USA
Phone: 303-675-2175 or 800-344-3860 Toll Free USA/Canada
Fax: 303-675-2176 or 800-344-3867 Toll Free USA/Canada
Email: orderlit@onsemi.com

N. American Technical Support: 800-282-9855 Toll Free
USA/Canada
Europe, Middle East and Africa Technical Support:
Phone: 421 33 790 2910
Japan Customer Focus Center
Phone: 81-3-5773-3850

ON Semiconductor Website: www.onsemi.com

Order Literature: <http://www.onsemi.com/orderlit>

For additional information, please contact your local Sales Representative