

GSB649A PNP EPITAXIAL PLANAR TRANSISTOR

Description

The GSB649A is designed for frequency power amplifier.

Features

*Low frequency power amplifier Complementary pair with GSD669A

Package Dimensions

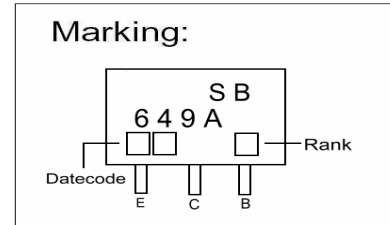
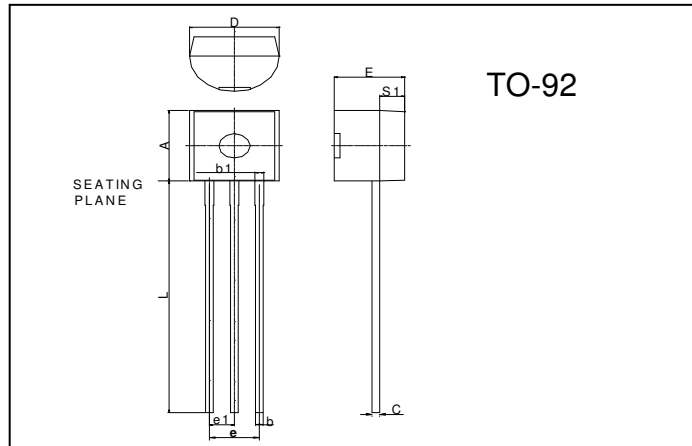

REF.	Millimeter		REF.	Millimeter	
	Min.	Max.		Min.	Max.
A	4.45	4.7	D	4.44	4.7
S1	1.02	-	E	3.30	3.81
b	0.36	0.51	L	12.70	-
b1	0.36	0.76	e1	1.150	1.390
C	0.36	0.51	e	2.42	2.66

Absolute Maximum Ratings (Ta = 25°C, unless otherwise specified)

Parameter		Ratings	Unit
Collector to Base Voltage	VCBO	-180	V
Collector to Emitter Voltage	VCEO	-160	V
Emitter to Base Voltage	VEBO	-5	V
Collect Current(DC)	IC	-1.5	A
Collect Current*(Pulse)	ICP	-3	A
Junction Temperature	Tj	+150	°C
Storage Temperature Range	TSTG	-55 ~ +150	°C
Total Power Dissipation	PD	1	W
Total Power Dissipation (TC=25°C)	PD	20	W

Electrical Characteristics (Ta = 25°C, unless otherwise specified)

Symbol	Min.	Typ.	Max.	Unit	Test Conditions
V(BR)CBO	-180	-	-	V	IC=-1mA, IE=0
V(BR)CEO	-160	-	-	V	IC=-10mA, RBE=∞
V(BR)EBO	-5	-	-	V	IE=-1mA, IC=0
ICBO	-	-	-10	uA	VCB=-160V, IE=0
*VCE(sat)	-	-	-1	V	IC=-600mA, IB=-50mA
*VBE(on)	-	-	-1.5	V	VCE=-5V, IC=-150mA
*hFE1	60	-	200		VCE=-5V, IC=-150mA
*hFE2	30	-	-		VCE=-5V, IC=-500mA
fT	-	140	-	MHz	VCE=-5V, IC=-150mA
Cob	-	27	-	pF	VCB=-10V, IE=0, f=1MHz

* Pulse Test: Pulse Width ≤ 380us, Duty Cycle ≤ 2%

Classification Of hFE1

Rank	B	C
Range	60-120	100-200

Typical Parameters Performance

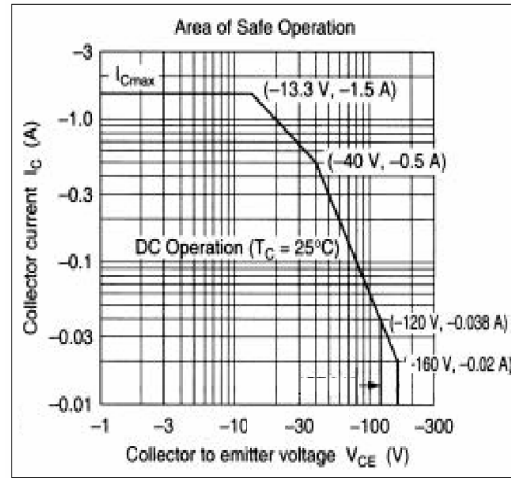
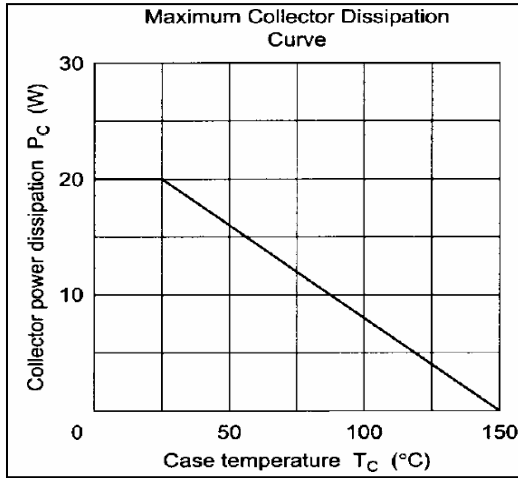

Characteristics Curve

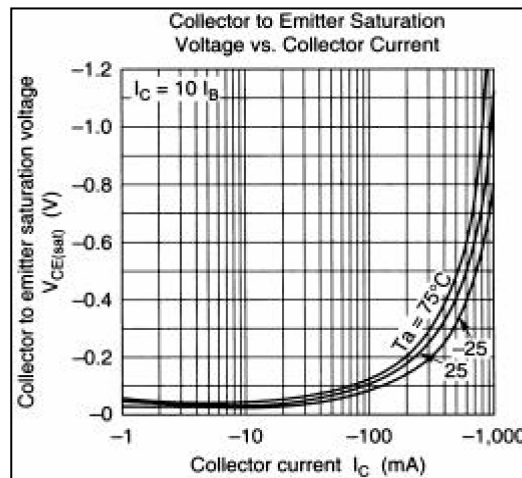
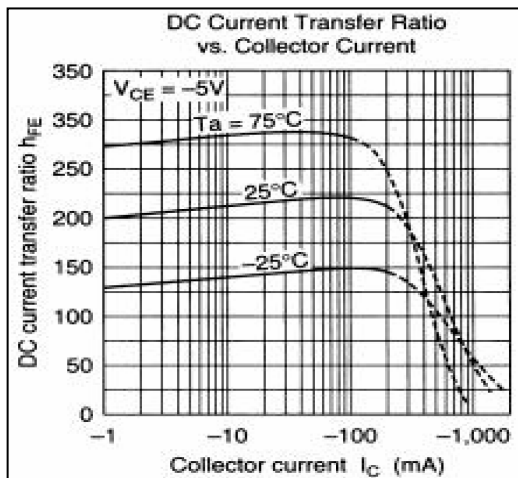
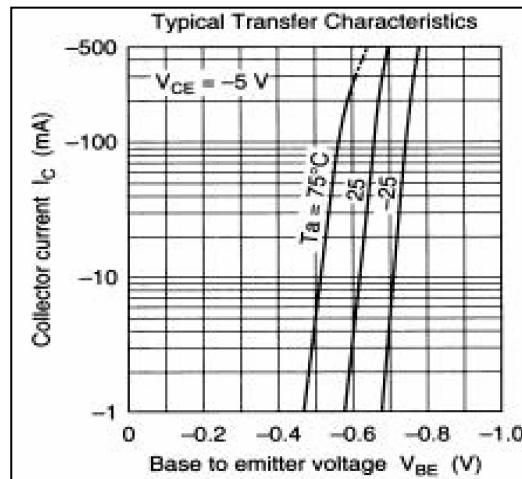
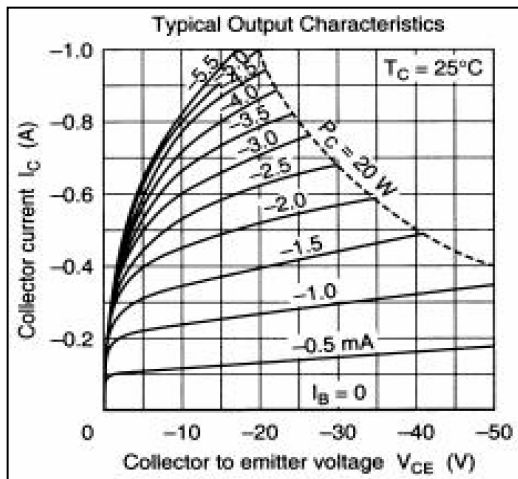

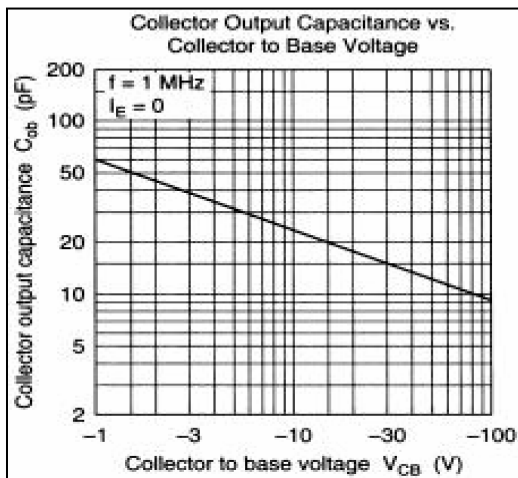
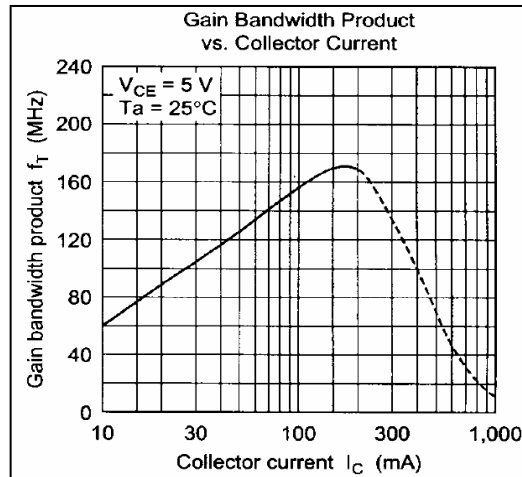
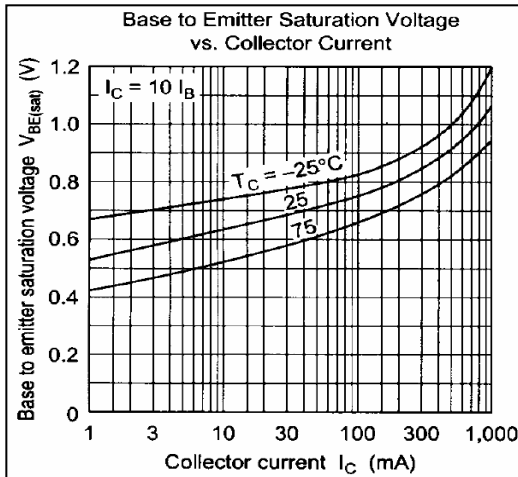

Important Notice:

- All rights are reserved. Reproduction in whole or in part is prohibited without the prior written approval of GTM.
- GTM reserves the right to make changes to its products without notice.
- GTM semiconductor products are not warranted to be suitable for use in life-support Applications, or systems.
- GTM assumes no liability for any consequence of customer product design, infringement of patents, or application assistance.

Head Office And Factory:

- **Taiwan:** No. 17-1 Tatung Rd. Fu Kou Hsin-Chu Industrial Park, Hsin-Chu, Taiwan, R. O. C.
- TEL : 886-3-597-7061 FAX : 886-3-597-9220, 597-0785
- **China:** (201203) No.255, Jang-Jiang Tsai-Lueng RD. , Pu-Dung-Hsin District, Shang-Hai City, China
- TEL : 86-21-5895-7671 ~ 4 FAX : 86-21-38950165